



Rooftop Dc Air Conditioner



Model: 2000R MINI

Instruction Manual

Thank you for purchasing this VELIT 2000R MINI Rooftop Air Conditioner. For safety and the best performance, please read and follow these instructions carefully. The latest electronic version of this document is available for download at the product page. We wish you enjoy your Velit air conditioner. For any product questions or issues, you can reach out to us at support@velitcamping.com or use the online chat box at velitcamping.com.

Table of Contents

1. IMPORTANT SAFETY INSTRUCTION	3
2. SPECIFICATIONS	4
3. INSTALLATION	5
4. OPERATION	8
5. TROUBLESHOOTING	11



1. IMPORTANT SAFETY INFORMATION

This manual has safety information to help users eliminate or mitigate the risk of accidents and injuries.

The installation of this unit MUST comply with the following code:

U.S: NFPA1192, NFPA70

CANADA: C22.1, CSA Z240

1.1 Understand Signal Words

⚠ WARNING

Indicates a hazardous situation that if NOT avoided, could result in death or serious injury.

⚠ CAUTION

Indicates a hazardous situation that if NOT avoided, could result in minor or moderate injury.

NOTICE

Indicates practices NOT related to physical injury

1.2 General Safety Message

⚠ WARNING

- This unit MUST be installed and repaired by qualified personnel who are familiar with the risk involved.
- Do NOT modify this product in any way. Any modifications can be extremely hazardous.
- Keep electrical devices out of reach of children and do not allow them to operate the device without supervision.
- Only use accessories authorized by Velit.
- Do NOT use this unit in or near flammable environment.
- Do NOT let children use the unit without supervision

NOTICE

- Do NOT use this unit when the ambient temperature is lower than 40°F. This could cause frost inside the unit.
- Do NOT power wash the unit or use detergent to clean the unit.

2. SPECIFICATIONS

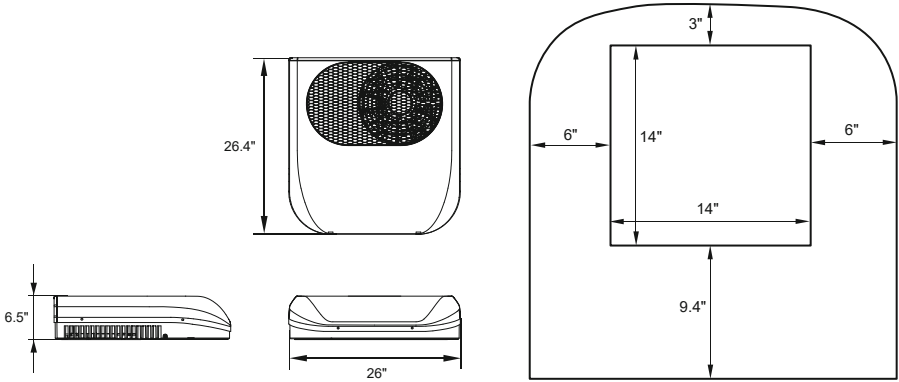

Model	2000R MINI	
Input Voltage	DC12V	DC48V
Cooling Capacity	7500BTU	8000BTU
Operating Current	15-50A	5-14A
Rated Power	600W	670W
Refrigerant	R134A / 500g	
Operating Temperature	38-125°F / 0-52°C	
Noise Level	ECO mode : 55dB Boost mode : 65dB	
Exterior Unit Dimension	W26.4" * L26" * H6.5"	
Weight	61.7lbs / 28KG	

3. INSTALLATION

3.1 Choosing Proper Location for the Air Conditioner

⚠ CAUTION

- Route the 6AWG power cable to the roof opening. Leave at least six inches of slack. For cables longer than 15ft, refer to NEC (National Electric Code) for proper sizing of wire (12V 60A).

⚠ WARNING

Make sure to disconnect all power supplies to the vehicle including battery, generator, and shore power prior to installation.

- The unit can fit over an existing 14-1/4 by 14-1/4 roof opening. For other locations, make sure the slope of the select location is less than 15 degrees and leave a clearance of at least 10" from the edge of the roof. Refer to specifications for the dimension of the unit.
- After the location has been selected, check for obstructions in the area where the unit will be installed.
- Check the inside of the camper for decor panel obstructions. Allow 6" clearance from all edges of the opening.
- Route the 6AWG power cable to the roof opening. Leave at least six inches of slack. For cables longer than 10ft, refer to NEC (National Electric Code) for proper sizing of wire (12V 60A).

3.2 Attach the Sealing gasket to the Roof Opening

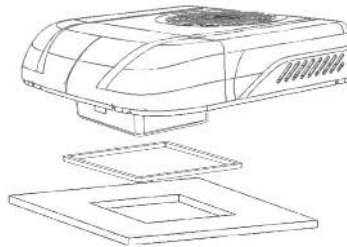

- Clean the surface between the unit and the roof where the sealing gasket will be installed.
- Apply sealant to the bottom of the sealing gasket. The sealant depends on the material of the roof.
- Place the sealing gasket on the roof opening.
- For better sealing, apply sealant to the edge where the sealing gasket contacts the roof.
- At the shown locations and other places if needed, stick the foam pieces between the unit and the roof to better support the unit

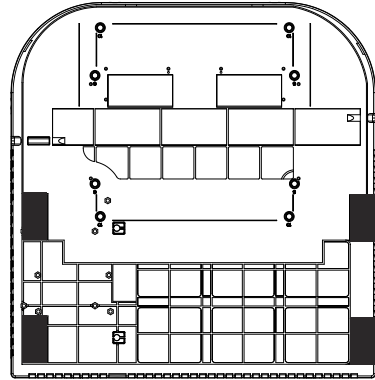
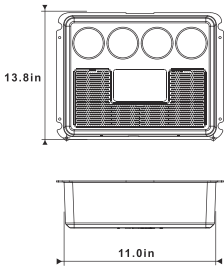

3.3 Place the Unit over the Roof Opening

- Grasp the bottom two sides of the unit, lift it, and place it over the roof opening.
- Pull out the power cable.

3.4 Secure the Unit to the Mounting Brackets

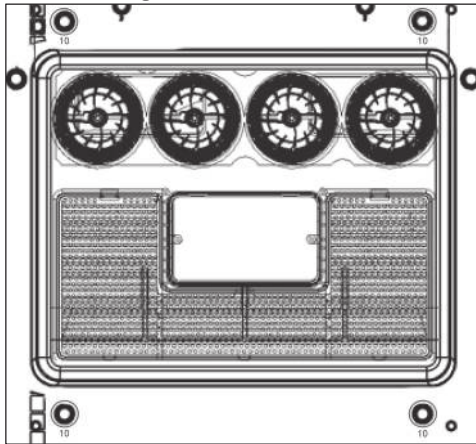

- Choose the proper length of M8 threaded rods based on roof thickness.
- Insert the threaded rods in the shown mounting holes (#10).
- Hand tightens four nuts all the way down to the bottom surface of the unit to secure the threaded rods

- Use the threaded rods as guidance, place the mounting brackets, and secure the brackets with provided washers and anti-slip nuts to 4.5-5.6NM (3.3-4.2 lb. Ft). Cut the threaded rods to desired length if needed.

NOTICE DO NOT OVERTIGHTEN!

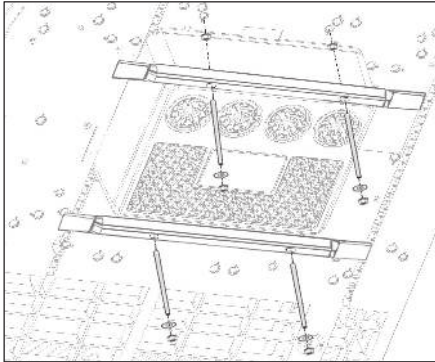

3.5 Connect Wiring

- Connect the power cable. On this end, the cable should have fuse boxes on both positive and ground.
- On the other end of the power cable, connect to the battery. On this end, there is only one fuse box on positive.

3.6 Install the Decor Panel

- Use the provided self-taping screws and washers to secure the decor panel to the roof.

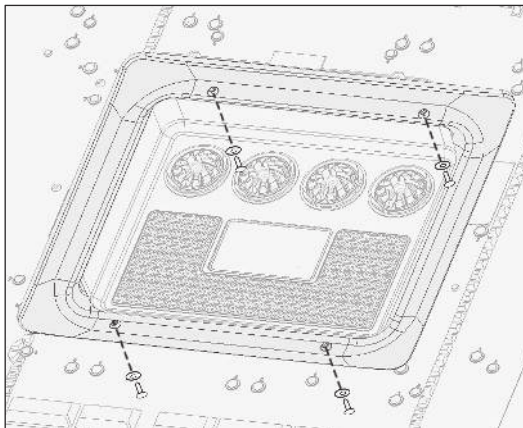

4.OPERATION

4.1 Modes

Mode changes only the compressor speed, Fan speed can be adjusted separately.Output from low to high:

Sleep:  ECO:  Cooling:  TURBO: 

4.2 Control Panel

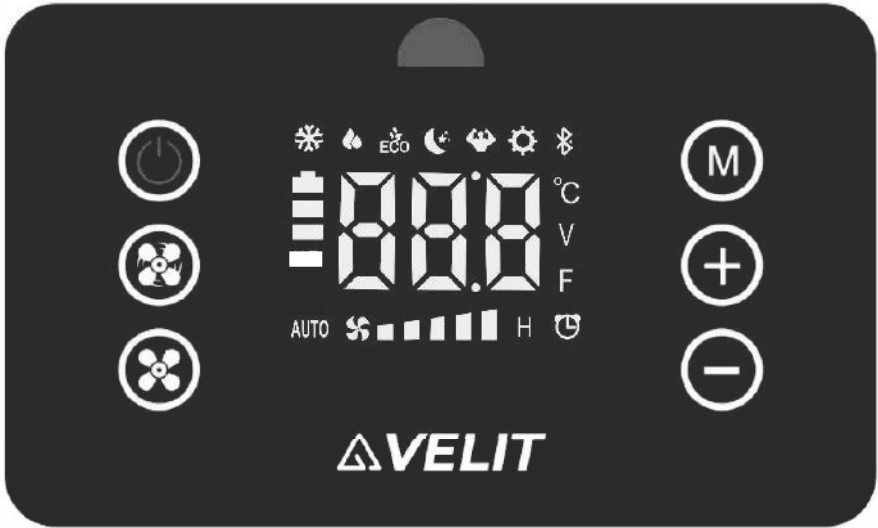

1 - Power ON/OFF: Short press to turn on unit. Long press 2s to turn off. Short press to turn off/on display while the unit is running

2-Mode Switch: Short press to switch between operating modes:Output from low to high output: Sleep, Eco, Cooling, Turbo.The mode only changes compressor speed. Fan speed can be adjusted separately.

3 - Fan Speed +: Increase fan speed











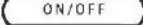



4-Fan Speed -:Decrease fan speed

5 -Temperature +:Increase setting temperature

6 -Temperature -:Decrease setting temperature

4.3 Remote Control

NOTICE This is a general-purpose remote. Some buttons do not apply to this model.

-  : Turn ON/OFF
-  : Switch between modes
-  : Change fan speed
-  : Increase temp
-  : Decrease temp
-  : Sleep mode
- ECO** : ECO mode
-  : Cooling mode
-  : Turbo mode
-  : View voltage
-  : Timer
-  : N/A
-  : N/A
-  : N/A
-  : N/A
-  : N/A

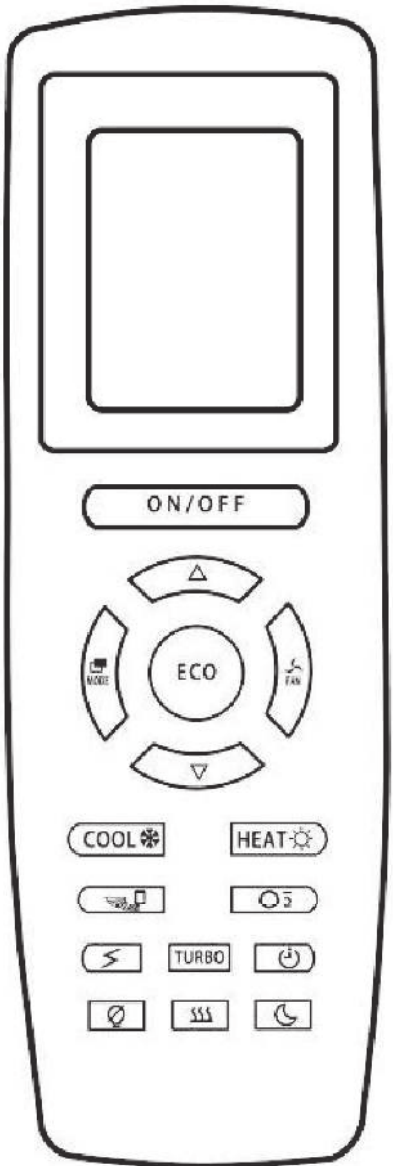

4.3 Switch Display Unit °C/°F

Method 1: When the unit is on, long press Mode button 3s

Method 2: When the unit is powered off, on the remote control, short press the mode button and down arrow button at the same time. The display unit on the remote will switch. Turn on the unit with the remote and the unit on the display panel will sync with the remote.

4.4 Under/Over-Voltage Protection

Low voltage protection will auto shut off the unit when the supplied voltage is lower than the cut-off voltage (default 10.5/21.5/40V) and the low-voltage red light will light up. The unit will turn on automatically once the supplied voltage is higher than the recover voltage(default 12/23/42V).

When the supplied voltage is higher than 18/36/72V, the unit will turn off and the high-voltage red light will light up. The unit will turn on automatically once the supplied voltage is lower than 15/30/60V.

4.5 Edit Low Voltage Protection

Long press the Mode Switch to edit low voltage protection. Press Fan Speed + to increase cut-off voltage. Press Fan Speed - to decrease cut-off voltage. Press Temperature + to increase recover voltage. Press Temperature - to decrease recover voltage.

4.6 Remote Controll App

Search for velit in App store / Google Play



Google Play



App Store

5. TROUBLESHOOTING

5.1 Error code

There are multiple sensors built inside the unit. When an error is detected, the error icon will flash with the error code displayed. Check the table below for the meaning of the error codes and contact customer service when needed.

Code	Cause	Troubleshooting
E0	Ambient temperature sensor(White 2 pin connector)	Use a fathead screw driver to pry open the display panel. Ensure the white 2pin connector seated properly. Replace the sensor or the display panel if needed
E1	Evaporator temperature sensor(Red 2 pin connector)	Use fathead screw driver to pry open the display panel. Ensure the red 2pin connector is seated properly. Replace the sensor or the display panel if needed.
E3	Blocked rotor	Contact customer service
E4/EL	Low-voltage	Check the system and battery voltage. By default, this error code triggers when voltage drops below 10.5V. Make sure the wiring is connected properly and there is no loose connections
E5	Short protection/faulty controller	Contact customer service
E6/EH	Over-voltage	Check the system voltage. It should be less than 15V
E7	Compressor startup failure	Contact customer service
E8	Condenser fan	Make sure condenser fan connector is seated properly.
EF	Evaporator blower fan	Make sure the blower fan connector is seated properly. Pry open the display panel and make sure the fuse is intact.
Eb	Controller phase loss	Contact customer service
EU	Controller overheated	Let the unit sit for ten minutes and restart the unit

