

# UGREEN

## 1024Wh | 1200W

### PowerRoam Portable Power Station

User Manual | Model: GS1200



# Contents

1. Product Overview	01
2. Specifications	02
3. Recharging Your Power Station	02
4. Powering Your Devices	05
5. App User Guide	07
6. Features & Operating Modes	07
7. FAQs	09
8. Troubleshooting	10
9. What's In The Box	11
10. Safety Instructions	12
11. Warranty Information	13

# Product Overview

## Product Details

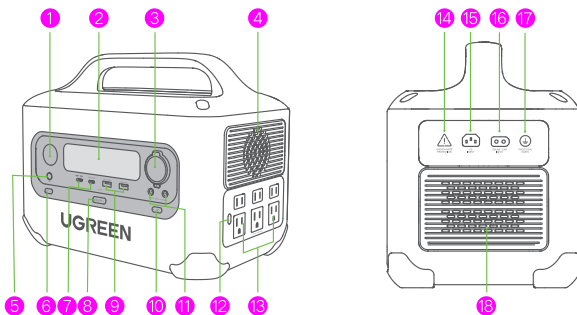

- ① Flashlight
- ② LCD Display
- ③ Car Charging Output Port
- ④ Ventilation Outlet
- ⑤ Flashlight Power Button
- ⑥ IoT Button/ IoT Indicator
- ⑦ USB-C Output Ports × 2
- ⑧ Main Power Button/Power Indicator
- ⑨ USB-A Output Ports × 2
- ⑩ DC Power Button/DC Output Indicator
- ⑪ DC5521 Output Ports × 2
- ⑫ AC Power Button/AC Output Indicator
- ⑬ AC Output Outlets × 6
- ⑭ Overcharge Protection Switch
- ⑮ AC Input Outlet (Utility Power)
- ⑯ DC Input Port (Solar/Car Charging)
- ⑰ Protective Earth Screw
- ⑱ Ventilation Outlet

## LCD Display

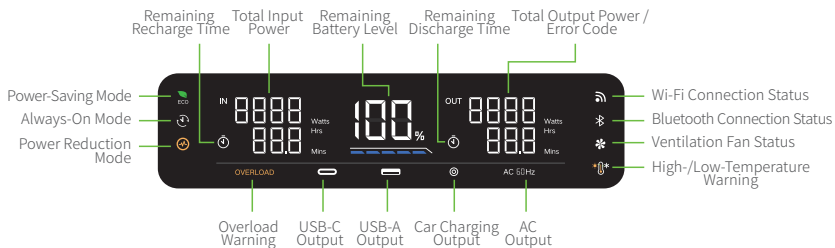

## Specifications

General Info	
Dimensions	34 × 22 × 27 (cm) / 13.4 × 8.7 × 10.6 (inch)
Net Weight	11.5 kg / 25.4 lbs
Lithium Battery Rated Energy	1024Wh 40Ah 25.6V
Input	
AC	100-130V~ 60Hz 15A Max
Solar	12-48V==15A 400W Max
DC/Car Charger	12V / 24V==8A Max
Output	
AC (×6)	120V~ 60Hz 10A 1200VA/1200W Max
USB-A (×2)	Single-Port: 5V==3A/9V==2A/12V==1.5A/5V==4.5A 22.5W Max (Dual-Port: 45W Max)
USB-C (×2)	Single-Port: 5V==3A/9V==3A/12V==3A/15V==3A/20V==5A 100W Max (Dual-Port: 200W Max)
Car Charger (×1)	12V ==10A 120W Max
DC5521 (×2)	Single-Port: 12V==5A 60W Max (Car Charger + DC5521 × 2 = 120W Max)
Total Output Power	1565W Max
Working Environment Temperature	
Discharging Temperature	-10°C~40°C (14°F~104°F)
Charging Temperature	0°C~40°C (32°F~104°F)

## Recharging Your Power Station

### Safety Precautions

- Before charging, please make sure the power station is properly grounded.
- Please use an original or safety-certified power cable that meets the charging specifications of this power station.
- When charging, ensure the power station is well-ventilated and free from combustibles.

## Important Note

- Please charge power station before initial use to activate.
- In order to ensure safety while charging, overcurrent protection will automatically trigger when the input current exceeds the overcurrent protection value. When this happens, the Overcharge Protection Switch will protrude. Once the overcurrent is abolished, press the switch to resume charging.
- If the power station shows a low battery, please recharge promptly. Refraining from prompt recharge may result in the battery becoming inoperable.

## AC Recharging

Recharge with PowerZip Fast Charging 1200W Max Input Power

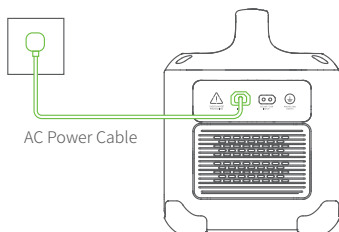

## Solar Recharging

To charge power station via solar panels, use the following configuration:

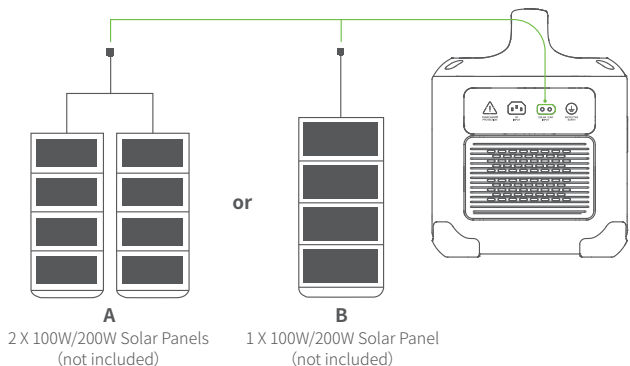

- Note:**
1. Up to 2 solar panels can be connected in series, maximum.
  2. 400W is the maximum wattage rated power input for supported solar panels connected in series. (Additional cables not included)

## Car Recharging

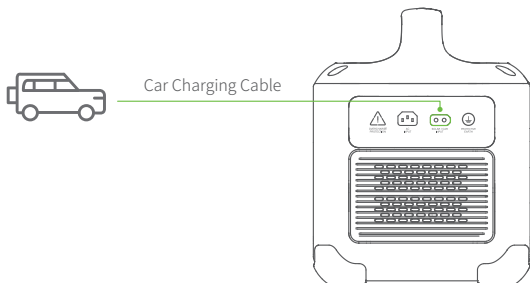

To charge power station via vehicle cigarette lighter port:

1. Please start the vehicle before recharging the power station with car charging cable. This will prevent vehicle failure to start due to insufficient battery.
2. Please ensure cigarette lighter port and the car charging cable are properly connected.

## Flashlight

In the standby state, you can switch between the 5 states:

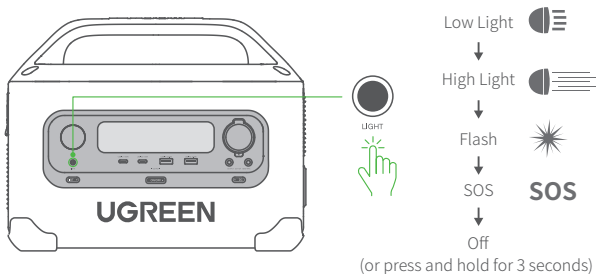

# Powering Your Devices

## Power On/Power Off

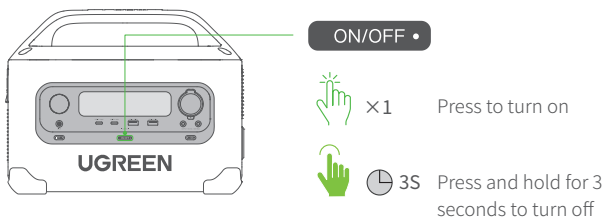

### Tip:

While powered on, if the power station is not used within 1 minute, the display automatically turns off. Press any button to turn display on.

## AC Output

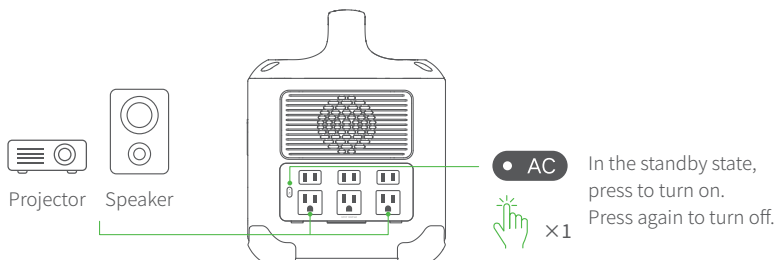

### Tips:

- To switch AC output frequency, press and hold the AC Power Button for 10 seconds while the AC output is off.
- Please check the rated frequency of the device before use. Improper frequency settings will result in damage to the power station and connected device(s).

## Car Charging Output / DC5521 Output

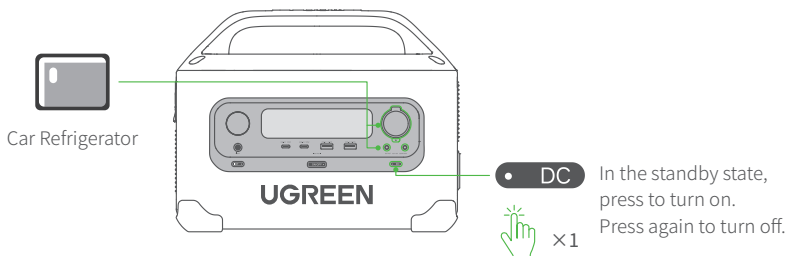

## USB Output

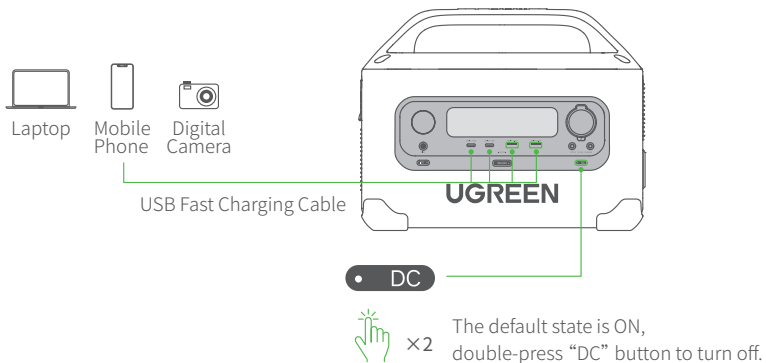

## App User Guide

To control the power station via mobile device, scan the QR code to download the "UGREEN" App:



**Tip:**

You can also search for "UGREEN" App via Apple Store or the Google Play Store.

## Features & Operating Modes

### U-Turbo

While the U-Turbo Mode is active, the AC output ports of the power station can support devices with power ratings of up to 2500W (Max).

**Tips:**

- For a safer charge, the U-Turbo mode is temporarily disabled while the power station is simultaneously charging and charging other devices.
- U-Turbo is enabled by default. You can disable it using the "UGREEN" App.
- If the U-Turbo Mode is on, it is recommended to connect only one device to the AC output port to avoid abnormal use of the power station.
- The AC output port can support devices up to 2500W like: hair dryers, electric kettles, etc., but U-Turbo Mode is not applicable for all electrical appliances. Inductive and high-power devices such as air conditioners, coffee machines, and clothes dryers are not recommended.

## Uninterruptible Power Supply (UPS)

Do not use UPS features in situations or with devices that require extreme reliability and/or security.

Examples include but are not limited to:

- Use with life-saving medical equipment like medical ventilators;
- Use in situations or environments that may cause severe bodily harm/injury (such as on airplanes, ships, railways, elevators, etc.).

This power station is not intended for use in any high-risk activities, such as activities where equipment failure can directly result in death, personal injury, substantial property damage, or activities that affect the operation of medical or similar equipment. UGREEN expressly disclaims any express or implied warranties of suitability for high-risk activities. Any such use is a misuse of the power station.

## Power Reduction Mode

In this mode, the recharging/discharging power of the power station is reduced. This is to improve the overall lifespan of the power station.

For safe use, Power Reduction Mode will automatically turn on in the following 4 states:

1. Low temperature
2. High temperature
3. Low battery charging
4. Trickle charging

(The Power Reduction Mode icon on the LCD display illuminates to indicate that the mode is on.)

## 0% Battery Emergency Mode

This mode allows for flashlight and USB ports usage when battery level is at 0%.

When powered on, press and hold the DC Power Button and Flashlight Power Button for 10 seconds at the same time to enable this mode. After use, press and hold the Main Power Button for 3 seconds to disable.

### Tips:

- This mode is only available when the battery level is 0%.
- Please avoid using this mode frequently, as power station battery life could be negatively affected.
- After using this mode, promptly charge the power station, otherwise it may become unusable.

## Operating Modes

Mode	Description	Setting
Standard Mode	In Standard Mode, the power station automatically shuts down if there is no device connected and no operation is performed within 5 hours after powering on	Default mode
Power-Saving Mode	In Power-Saving Mode, the power station automatically shuts down if there is no device connected and no operation is performed within 2 hours after powering on	While power station is on, double-press Main Power Button to enable/disable this mode
Always-On Mode	In Always-On Mode, the power station remains on until the battery is depleted or the power station is manually turned off	While power station is on, press and hold AC Power Button for 3 seconds to enable/disable this mode

## Factory Reset

To perform a factory reset, ensure the power station is not connected to any other device/appliances/etc. Press and hold the AC Power Button and the DC Power Button simultaneously for 10 seconds to restore the power station to factory settings.

### Note:

This operation will clear all function settings, etc. saved by the power station. Perform reset with caution.

## FAQs

### Q1: What devices can be connected to the AC Output Port of the power station?

A1: The rated power of the AC output port of this power station is 1200W, which can power most electronics, but it is recommended that you confirm the power of the device before use and ensure that the sum of the power of all load devices is less than the rated power. When turning on the U-Turbo function, AC output port of the power station can support heating devices with a rated power of up to 2500W. But the function is not suitable for all devices. Inductive and high-power devices such as air conditioners, coffee machines, and clothes dryers are not recommended.

### Q2: Can I recharge the power station while charging connected devices?

A2: Yes. It is not recommended to power high-power devices when using this feature.

### Q3: How can I check remaining discharge time?

A3: After a device is connected, the estimated remaining discharge time for the power station will be shown on the display. This is calculated based on the actual power of the connected device and the remaining battery level of the power station. If the actual power of the connected device is high and the power station's remaining power is low, the remaining discharge time is short.

#### Q4: Why does the fan turn on during use?





A4: The fan automatically turns on to cool the power station, which is normal and provides a safer charge.

You can reduce the sound caused by the fans by turning on [Quiet Mode] in the "UGREEN" App [Settings].

#### Q5: Why does the power station run out of battery even when no device is connected?

A5: When the AC Output Outlets are on, even if no device is connected, there will be a certain amount of no-load power consumption. To avoid this, please ensure the AC Output Outlets are turned off when not in use to conserve battery.

## Troubleshooting

Indicator	Problem	Solution
OVERLOAD	Output Overload	Remove all connected external devices from the power station then restart the power station.
	Low-Temperature Protection	Move the power station to a working environment temperature as previously specified by this manual before continued use.
 +F03	Charging High-Temperature Protection	Method 1: Open the App to enable Quiet mode. Method 2: Stop charging the power station, turn it off and wait 10 minutes before resuming charge.
 +F17/F50	Temperature Detection Failure	Please cease use immediately and contact UGREEN Customer Service.
 +F10/F12/ F49	Discharging High-Temperature Protection	Remove all connected external devices from the power station, place the power station in a cool and well-ventilated environment, then wait 10 minutes. After 10 minutes, turn it on again.
F05	Discharge Undervoltage Protection	Battery is low, please charge promptly
F22	DC Output Failure	Please cease use immediately and contact UGREEN Customer Service.
F33	USB-A1 Output Failure	
F36	USB-A2 Output Failure	
F37	AC Charging Input Overvoltage	Please check whether input voltage is within the appropriate voltage range required by this manual. If the input voltage is normal, please contact UGREEN Customer Service.
F38	AC Charging Input Undervoltage	
F39	DC Charging Input Overvoltage	

**Note:** In the case of an unsettled issue, please contact UGREEN Customer Service.

## What's In The Box

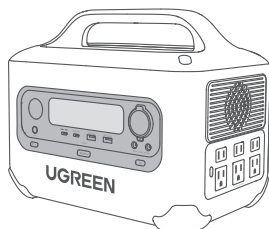

1 × 1200W PowerRoam Power Station

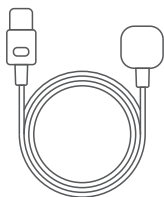

1 × AC Power Cable

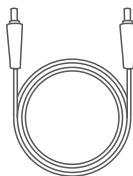

1 × DC5521 to DC5525 Cable

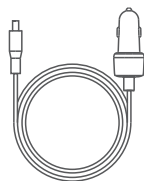

1 × Car Charging Cable

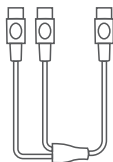

1 × Solar Parallel Adapter

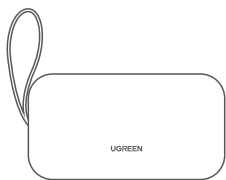

1 × Accessory Storage Bag



1 × User Manual



1 × Warranty Card

# Safety Instructions

## Warnings

- This power station contains a lithium battery; please do not disassemble, violently impact, or squeeze the power station.
- Do not throw the power station into fire, or use it in situations of high temperature and during short circuit.
- Do not insert foreign objects or fingers into the power station or use sharp objects to puncture it, so as to avoid damaging the power station or unintentionally causing an explosion due to abnormal use or short circuit.
- If the power station accidentally falls into water, it should be immediately moved into a safe, open area until it is completely dry. Do not use it again. Dispose of it properly according to the Disposal Guide detailed in this manual.
- Due to the particularity of the power station (built-in battery, high-voltage, etc.), please keep the power station out of reach of children and pets. Special groups are recommended to use it under the protection and supervision of a designated guardian.

## Notes for Safe Use

- Do not place heavy objects on this power station.
- Please use the power station in a dry and well-ventilated environment. While in use, ensure the ventilation outlets of the power station are not blocked.
- Do not place the power station near sources of heat or fire, such as microwave ovens, pressure cookers, heating furnaces, etc. If the power station catches fire, please use fire extinguishing equipment as quickly as possible.
- Do not expose the power station to any liquids and do not use it in rainy or humid environments.
- If the power station is subjected to strong impact or fall, do not continue normal use. Please dispose of it properly according to the Disposal Guide in this manual.
- Do not use this power station in environments of strong electrostatic or electromagnetism.
- When not in use, please remove the power cord of the power station and all connected external devices. When unplugging the power cable, please pull it out from the plug directly, rather than pulling on the cord.
- Do not use non-UGREEN cords or parts. If repair or replacement parts and/or accessories are required, please contact UGREEN customer service.
- Do not use a damaged power cable to charge the power station.
- Please use the power station at the specified working environment temperature.

## Transportation & Storage

- Please store this power station in a dry place, at room temperature.

- Do not store or transport this power station with metal objects (glasses, watches, metal necklaces, hairpins, etc.).
- If you want to ship this power station via logistical means, please discharge the power station battery to 10%-30%.
- This power station cannot be carried on a plane. Please abide by the relevant regulations of civil aviation transportation.

## Maintenance

- For long-term storage, please put the power station in the storage bag. Please charge and discharge at least once every 3 months (discharge to 30%, then charge it to 60%) to ensure battery health.
- For long-time storage, please check the power station's remaining battery level. If it shows a low battery, please charge first, otherwise the battery may be damaged.
- Please store the power station at the appropriate storage environment temperature (20°C~25°C/68°F~77°F) specified in this manual.
- If the port of the power station is dirty, please clean with a dry cloth. Do not clean with chemicals or spray cleaners.

## Disposal

- Please dispose of this power station in accordance with local laws and regulations regarding battery recycling and disposal. Do not dispose of it in ordinary trash.
- Be sure to fully discharge the battery of this power station before disposing of it in the designated battery recycling bin.
- If the battery cannot be completely discharged due to product failure, please contact a professional battery recycling company for further processing.

## Disclaimer

Before use, please read this manual carefully, and use the power station correctly in accordance with all safety instructions in this manual. Relevant safety precautions especially must be followed. After reading, please keep the manual for future reference.

To the extent permitted by law, improper use of this power station may directly or indirectly result in damages to the power station and/or personal property and cause personal injury. UGREEN will not assume any legal responsibility. Under the condition of compliance with laws and regulations, UGREEN has the final right to interpret this manual and other related documents of this power station. The User Manual is subject to update, revision, or termination without notice, but updates can be received via the "UGREEN" App, or <https://www.ugreen.com/>.

## Warranty Information

A limited 5-year warranty applies to all UGREEN portable power stations purchased from UGREEN and authorized sellers. Please feel free to contact us if you run into any problems. For more details on the warranty, please visit: [www.ugreen.com](http://www.ugreen.com)

All data shown are based on UGREEN laboratory testing.  
Actual results may vary according to specific circumstances.