

TIMEGUARD®

16A Single Channel DIN Rail
Digital Timer (Single Module)
Model: NTDR1C16



1. General Information

These instructions should be read carefully and retained for further reference and maintenance.

Note: Timeguard reserve the right to alter these instructions at any time. Up to date instructions will always be available for download at www.timeguard.com

2. Safety

- Before installation or maintenance, ensure the mains supply to the timer is switched off and the circuit supply fuses are removed or the circuit breaker turned off.
- It is recommended that a qualified electrician is consulted or used for the installation of this timer and install in accordance with the current IEE wiring and Building Regulations.
- Check that the total load on the circuit including when this timer is fitted does not exceed the rating of the circuit cable, fuse or circuit breaker.
- To clean use a clean dry cloth only. Do not use liquid cleaners.

3. Technical Specifications

- Mains Supply: 220-240V AC 50Hz
- Class Protection: Class II
- IP Rating: IP20
- Operating Temperature: 0° to 40°C
- Switch Rating: 16A Resistive 2A Inductive at 230V AC
400W LED at 230V AC
Volt free switching
- Programmable Slots: 6 Programmes
- Programmable Sequences: Mon - Fri, Sat - Sun, Mon - Sat, Mon - Sun or individual days
- Manual Override: Yes
- Time Deviation: 2 seconds per day
- Power Reserve: Up to 1000 hours
- Installation Type: DIN Rail mount
- Terminal connections: 2.5mm² max
- Dimensions (H x W x D): 90mm x 18mm x 60mm
- Front Projection From DIN Rail: 55mm
- CE / UKCA Approved

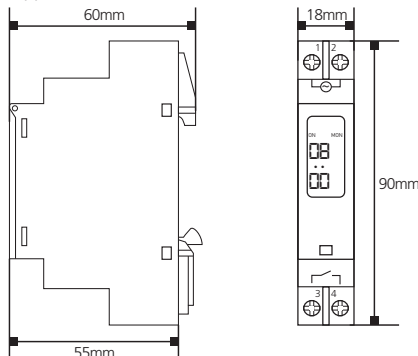

4. Installation

- Ensure the mains supply is switched off and the circuit supply fuses are removed or the circuit breaker turned off.
- Cover or shield any adjacent live components
- This timer is designed to be din rail mounted and as such should be installed in accordance with BS EN 60715.
- Terminate the 230V 50Hz supply and load cables to the terminal block ensuring the correct polarity is observed and that all bare conductors are sleeved. See section 5 Connection Diagram.

5. Connection Diagram

NTDR1C16 230V 50Hz Mains Switching

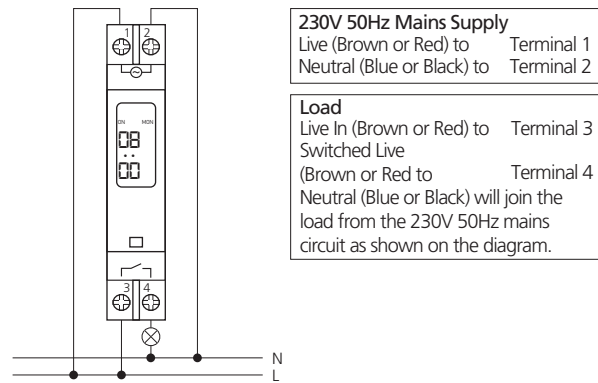

NTDR1C16 Volt Free Switching

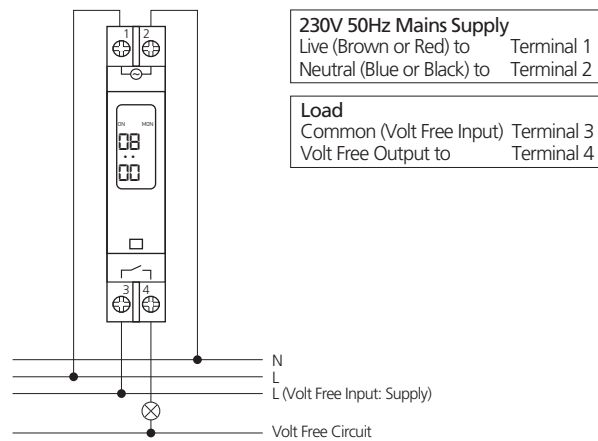

6. Battery

- The time switch has a factory fitted rechargeable battery to give clock operation and programme memory back up during loss of mains supply.
- Before programming for the first time, connect the unit to the mains supply for at least 15 minutes. Prior to programming, press the reset button marked as "R" on the unit.
- If the display is not visible or very faint, charge for 4 hours prior to pressing the reset "R" button and programming.
- The NTDR1C16 has a battery reserve of up to 1000 hours.

7. Button Controls

- Please take note of the button controls for the timer for the next stages of setting up the unit.

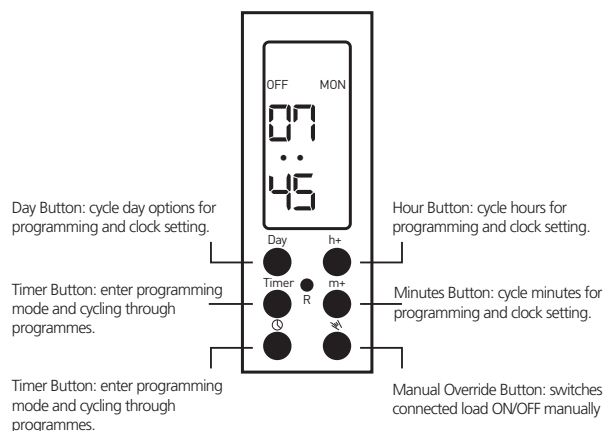

8. Reset

- The time switch must be reset before programming for the first time, or after subsequent discharge for more than 5 days, and following a 4 hour period of charging.
- Press the reset "R" button once using a pointed object e.g. a pencil or a paper clip.
- The display will show all characters / digits and then will clear to display the following characters as shown on the right image while flashing.



9. Setting the clock

- To set the local time and day of the week press and hold the clock setting button.
- While the clock setting button is held down in place, press the day button to set the current day of the week. The day on the right hand side of the display will change as you toggle through to find your selected day.
- Once the day has been set, perform the same action but with the hour and minute buttons to set the current local time. Please be reminded that the clock setting button must still be held down in place while also pressing the hour button to toggle to the appropriate setting. Release the clock setting button to exit clock setting mode. The display should now reflect the current local time with the correct day of the week.

10. Programming ON/OFF times

- To enter programming mode on the unit, press the timer button.
- The display will show the number "1" and "ON" which refers to programme 1 ON time.
- Press the day button to alter the day(s) of the week the programme is active.
- Once you have set the day(s) for which programme 1 ON will operate, press the hour button. The display will now show "00" on screen where the hours are represented. Continue to press the hour button until the correct hour is reached for programme 1 ON.
- Once you have set the hour for which programme 1 ON will operate, press the minute button. The display will now show "00" on screen where the minutes are represented. Continue to press the minute button until the correct minute is reached for programme 1 ON.
- The display will now show the projected ON time for programme 1 ON.
- To set the OFF time for programme 1, press the timer button. The display will show the number "1" and "OFF" which refers to programme 1 OFF time.
- Press the day button to alter the day(s) of the week the programme is active, this will determine the days the programme will switch of for programme 1 OFF.
- Once you have set the day(s) for which programme 1 OFF will operate, press the hour button. The display will now have "00" on screen where the hours are represented. Continue to press the hour button until the correct hour is reached for programme 1 OFF.
- Once you have set the hour for which programme 1 OFF will operate, press the minute button. The display will now have "00" on screen where the minutes are represented. Continue to press the minute button until the correct minute is reached for programme 1 OFF.
- The display will now show the projected OFF time for programme 1 OFF.
- If additional programmes are required, press the timer button and repeat the steps from bullet point 2 in this section. The display will read "2" and "ON" referring to programme 2 ON if a second schedule is required. If no other programmes are required, press the clock setting button to exit programming mode. The local time will now be shown on screen.

Example 1

The following example illustrates programme 1 ON switching on at 07:45 every day of the week.

Programme 1 OFF will switch off at 13:45 every day of week.

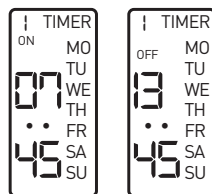

Example 2

The following example illustrates programme 2 ON switching on at 20:00 every day of the week.

Programme 2 OFF will switch off at 23:45 every day of week.

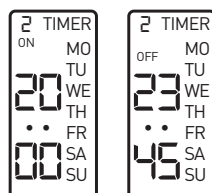

11. Modify or adding programmes

- To modify an existing programme, press the timer button, programme 1 ON will be displayed on screen. If this is the programme required for modification press the day, hour or minute buttons to alter the time and day(s) the programme will run.
- If you wish to modify a different programme, continue to press the timer button until the desired programme is shown which requires modification.
- To add an additional programme continue to press the timer button until an empty programme slot becomes available, an empty slot will have dashes "-" on the display where the hours and minutes are represented for the ON or OFF programme times. Follow section 10 bullet point 3 to add a an additional programme if required.

12. Cancel programmes

- To cancel an existing programme, press the timer button, programme 1 ON will be displayed on screen. If this is the programme required for cancellation, press the hour and minute buttons until "--" is shown on the display where both the hours and minutes are represented.
- If a programme slot shows as "--" for both the hours and the minutes, the programme will not run meaning the programme is either canceled or unassigned for any ON or OFF time.

Example 3

The following example illustrates programme 1 ON & OFF previously shown on example 1 showing as cancelled. Note that dashes "--" for both the hours and minutes. This indicates that the programme is terminated or non functional.

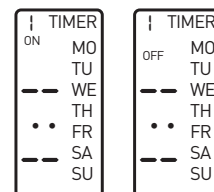

12. Manual Override

- The manual override button will switch ON/OFF the connected load at anytime bypassing the units current programmed state.
- If the manual override button was configured to be in the ON position prior to the programmed ON time starting, the pre programmed OFF time will switch off the load as normal at that scheduled time.
- If the manual override button was configured to be in the OFF position after the programmed ON time starting, the load will remain switched off until the next programme ON time.

3 Year Guarantee

In the unlikely event of this product becoming faulty due to defective material or manufacture, within 3 years of the date of purchase, please return it to your supplier with proof of purchase and it will be replaced free of charge. For years 2 to 3 or with any difficulty in the first year, telephone our helpline. Note: a proof of purchase is required in all cases. For all eligible replacements (where agreed by Timeguard), the customer is responsible for all shipping and postal charges outside of the UK. All shipping costs are to be paid in advance before a replacement is sent.



If you experience problems, do not immediately return the unit to the store. Email the Timeguard Customer Helpline: helpline@timeguard.com or call the helpdesk on 020 8450 0515

Qualified Customer Support Coordinators will be online to assist in resolving your query.



Deta Electrical Co Ltd
Panattoni Park, Luton Road,
Chalton, Bedfordshire, LU4 9TT
Sales Office: 020 8452 1112
or email csc@timeguard.com

www.timeguard.com
67.058.699 (Issue 2)