

WIDE / SLIM MPL / SLIM MGR

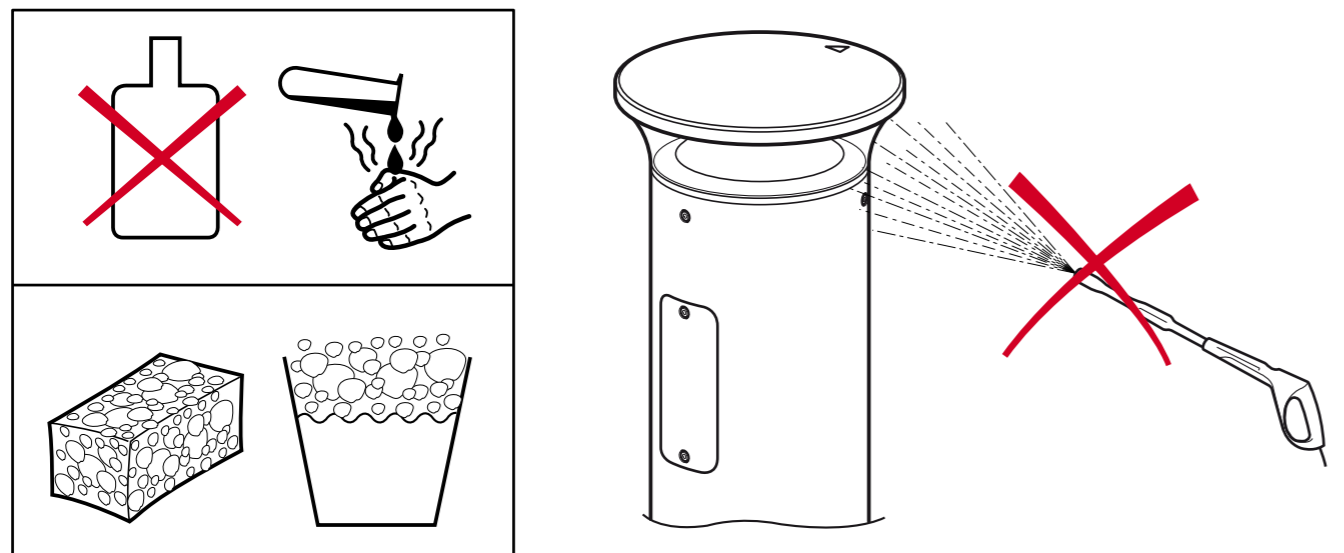
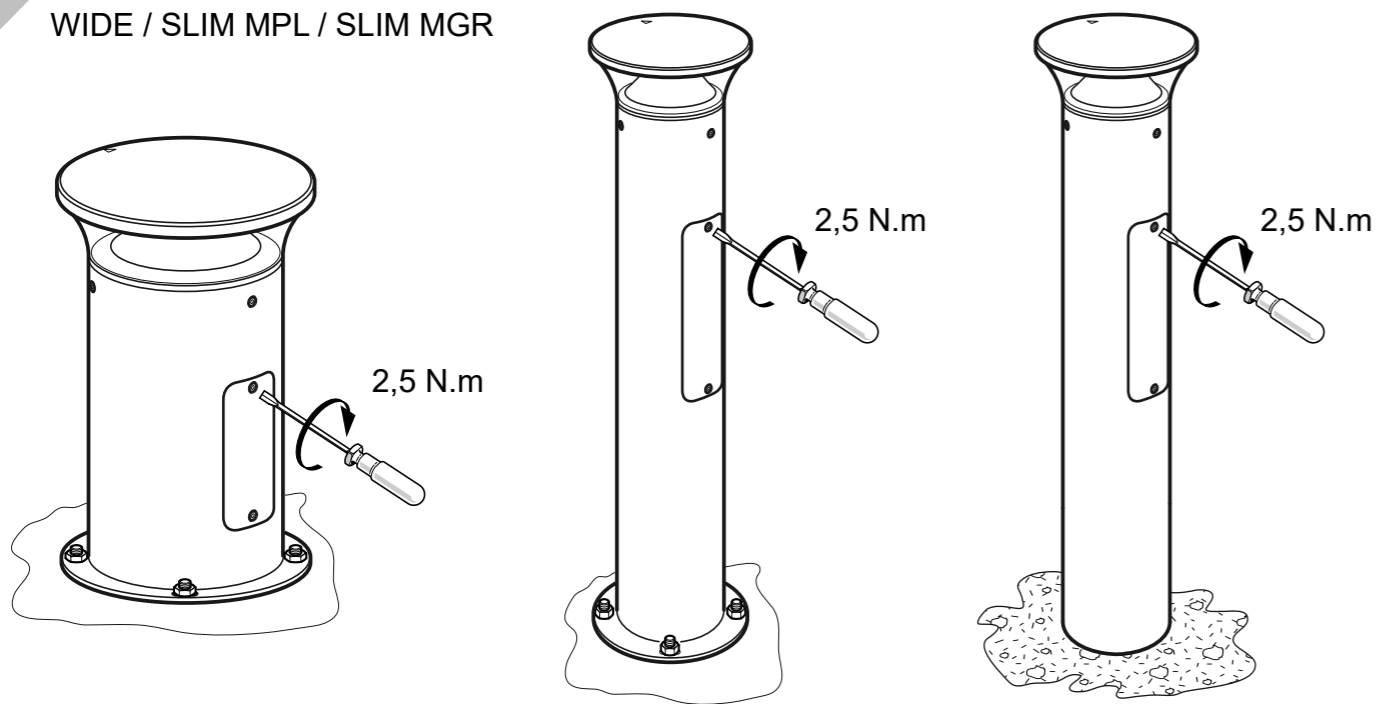

THOR BOLLARD

THORN

UK Installation instructions

DE Montageanleitung

CZ Montážní návod

DK Monteringsvejledning

EE Paigaldusjuhend

FI Asennusohje

FR Notice de montage

HU Szerelési útmutató

IT Istruzioni di montaggio

LT Montavimo Instrukcijos

LV Instalācijas instrukcija

NO Monteringsanvisning

PL Instrukcja montażu

SE Installationsanvisning

RU ИНСТРУКЦИЯ ПО МОНТАЖУ

TYPE : THOR BOLLARD WIDE
THOR BOLLARD SLIM MPL
THOR BOLLARD SLIM MGR

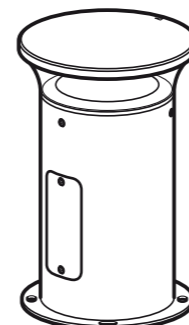

WIDE

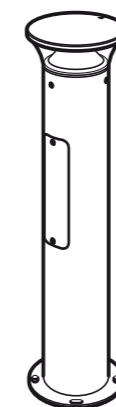

SLIM MPL

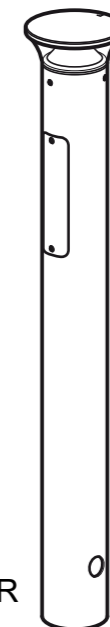

SLIM MGR

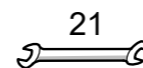

T30 creux / Hollow

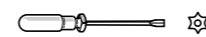

LED



CLASS I

CLASS II

IK10

IP66

CE

La source lumineuse contenue dans ce luminaire ne doit être remplacée que par le fabricant ou son agent de maintenance ou une personne de qualification équivalente.

The light source contained in this luminaire shall only be replaced by the manufacturer or his service agent or a similar qualified person

Caution, risk of electric shock

Danger, risque de chocs électriques



WIDE

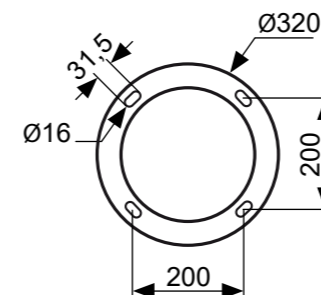
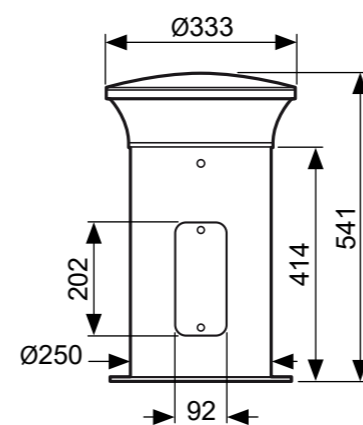

SLIM MPL

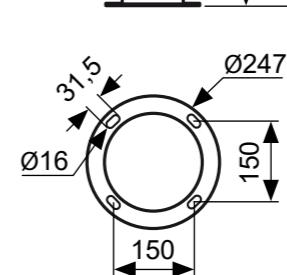
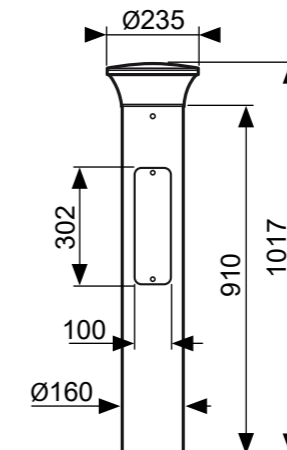

SLIM MGR

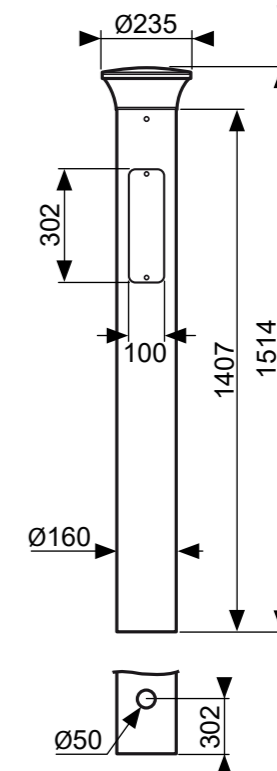

THOR BOLLARD	
	(kg)
WIDE	9.0
SLIM MPL	7.7
SLIM MGR	9.3

