

THE **OUTDOOR** PLUS

1-Hour Gas Timer with E-Stop

Models:
OPT-ESTOPTM

Owner's Operation and Installation Manual

WARNING

- Read these instructions carefully. Failure to follow these instructions completely could damage the product or cause a hazardous condition.
- Check the ratings given in the instructions and on the product your installing to make sure the E-Stop Gas Timer is suitable for your application. See description below.
- Installer must be a trained, experienced service technician or gas plumber.
- After installation is complete, check out product operation as provided in these instructions.

DESCRIPTION

The 1-Hour Gas Timer with E-Stop is an emergency shut-off, mechanical timer, and manual shut-off gas valve designed to be installed on the inlet side of a gas appliance to enable the user to control the time gas is allowed to flow to a gas appliance. This is a mechanical timer (no batteries or power required) that has the ability to control gas flow for 1-hour (60 minutes). In addition, both models have an emergency shut-off (red knob) that enables the user to quickly and easily shut the gas completely OFF, should the need arise.

The 1-Hour Gas Timer with E-Stop body is 4-inches high x 2 7/8 -inches wide x 2 1/8 -inches deep and can replace a manual shut-off valve and meet local code requirements as the accessible shut-off valve. It can be use for multiple applications (indoor or outdoor) from gas fire pits, gas grills, gas logs, gas torch lights, etc., wherever a shut-off valve is a requirement or a specified by a customer.

SPECIFICATION

Pipe Size: 1/2" NPT (2) inlets and (2) outlets

CSA Rated Capacity: 165,000 Btu/Hr at 1" Pressure Drop (NG)

Timer Accuracy: 60 Min. +/- 15% or 2.5 Hrs. +/- 15%

Multiple Mounting Holes: Uses 3/16-24 machine threads

CSA Certified: Tested to ANSI Z21.21; CSA 6.5

Maximum Pressure: 1/2" PSI

Ambient Temperature: 0°F to 175°F (79°C)

Inlets: Have fine mesh screens to filter any debris

Designed For: Natural or LP Gas (no conversion required)



CALIFORNIA PROPOSITION 65

WARNING

This product can expose you to Chromium, which is known to the state of California to cause cancer and birth defects or other reproductive harm.
(For more information, go to: www.p65warnings.ca.gov)

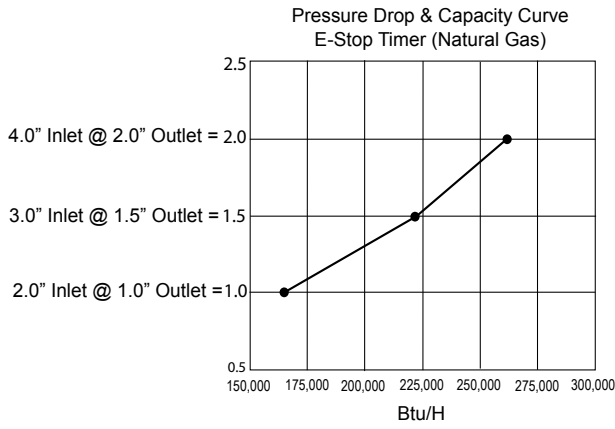

Table 1 Pressure drop and capacity for Natural Gas.

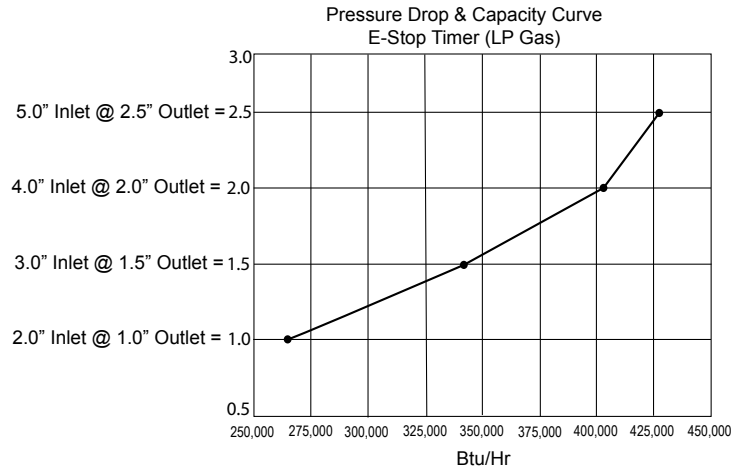

Table 2 Pressure drop and capacity for LP Gas).

Note: Pressure drop information listed is generated in American Flame lab and is to be used as reference only.

MOUNTING

The 1-Hour Gas Timer with E-Stop has the ability to be mounted from the side of the body, using the four (4) provided holes (two mounting holes per side) or using the two mounting hole tabs at the top and bottom of the body when facing forward. Each mounting hole uses 3/16 - 24 machine screws to secure it into position. **Note:** We recommend using stainless steel screws for any outdoor applications. See Fig. 1 for details.

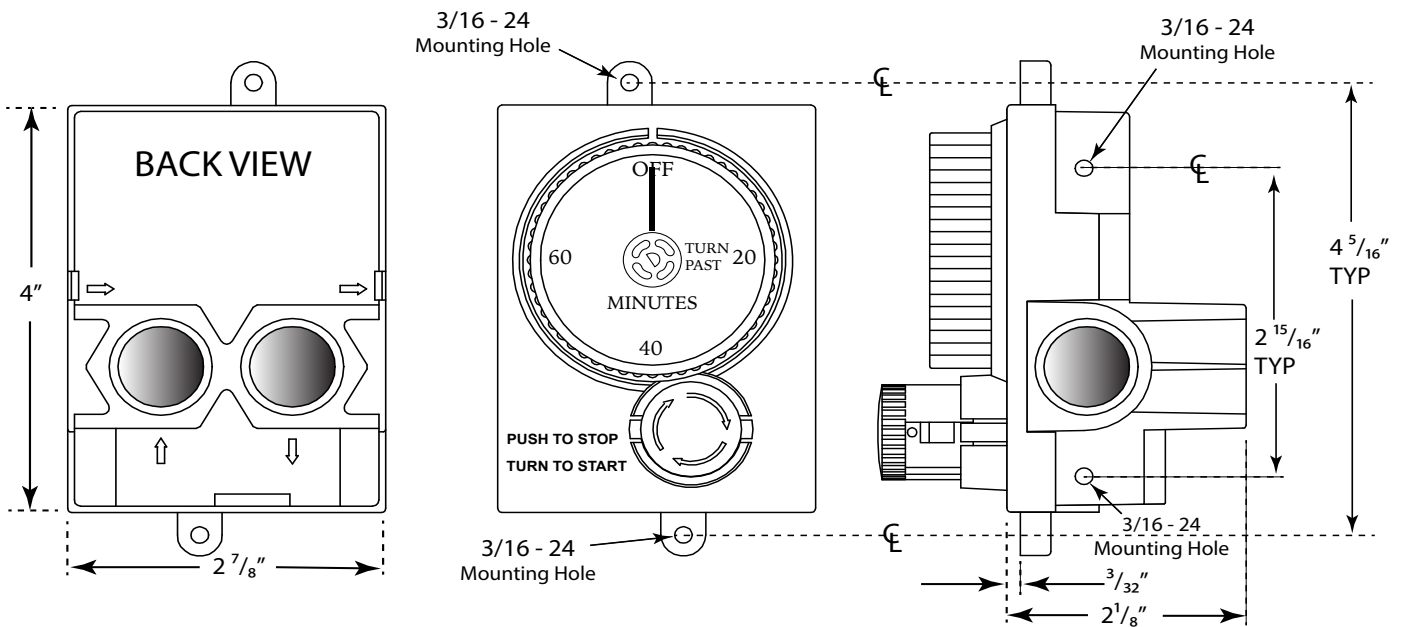

Fig. 1 E-Stop Gas Timer mounting hole locations applicable to both models.

INSTALLATION

The recommended installation position is up-right as shown in Fig 2, view "D". It has two (2) inlet and two (2) outlet gas connections. The diagrams below provide possible ways to plumb the E-Stop (See Fig. 3). Two (2) ½" NPT plugs are provided with the E-Stop. Plug the inlet and outlet connections not being used for the application. Connect gas supply to the inlet with the ⇨ arrow pointing into the valve. Connect outlet side to the gas appliance (See Figs. 2 & 3 for details).

NOTE: Conduct a gas leak test on the E-Stop Gas Timer after plumbing is complete.

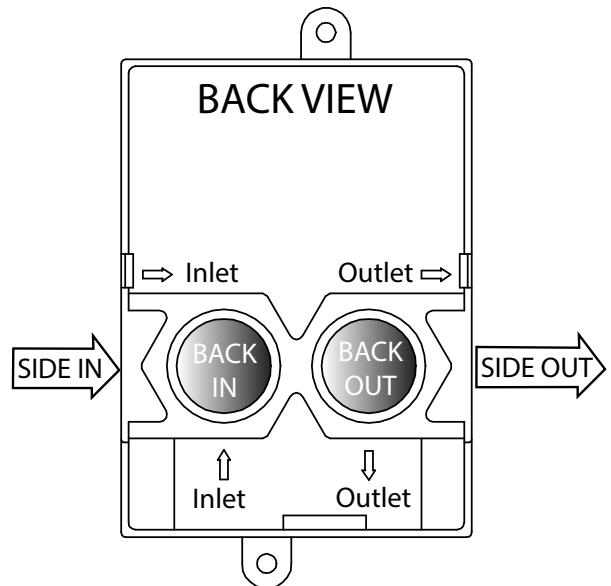

Fig. 2 Inlet and outlet connections.

"A-C" Shows Top View of E-Stop

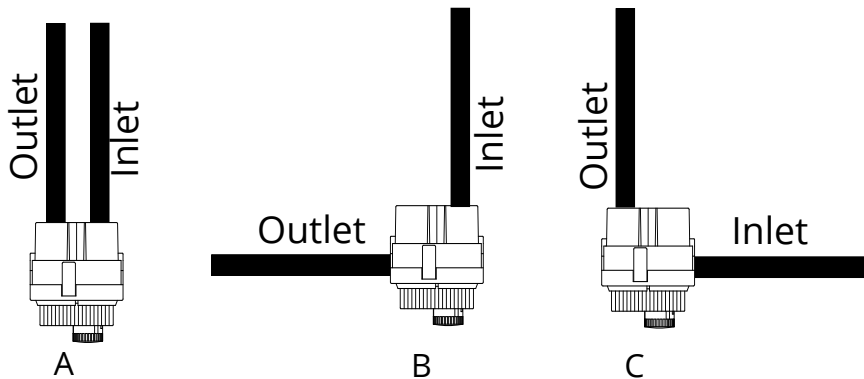
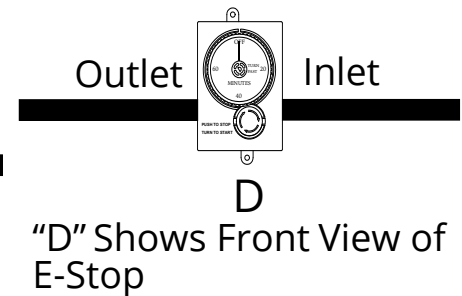

Fig. 3 Plumbing options



"D" Shows Front View of E-Stop

OPERATION

TO TURN ON

Step 1: Rotate the clear timer dial past 20 (ESTOP1-0H) or past 0.5 (ESTOP2-5H) to set the time. Timer will begin "ticking" when the dial is turned while the countdown time is set. **Step 2:** Turn red knob clockwise (about a ¼ turn) until it pops outward. Gas will now flow to enable you to light the appliance.

TO TURN OFF:

Let timer expire or simply press red knob inward until it stops. The red knob will lock down with a "click" and stop gas flow. See Fig. 4 and Fig. 5 on following page.

Note: Do not force the timer dial to the OFF position after time is set (This will weaken the spring inside the timer body and affect the accuracy of the time).

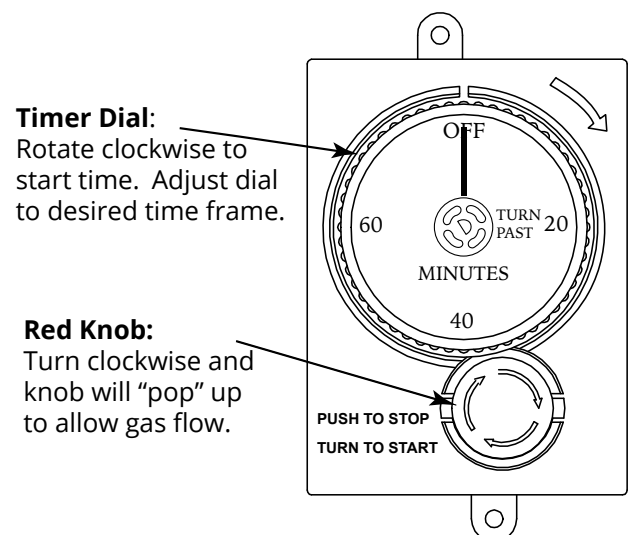

Fig. 4 E-Stop operation.

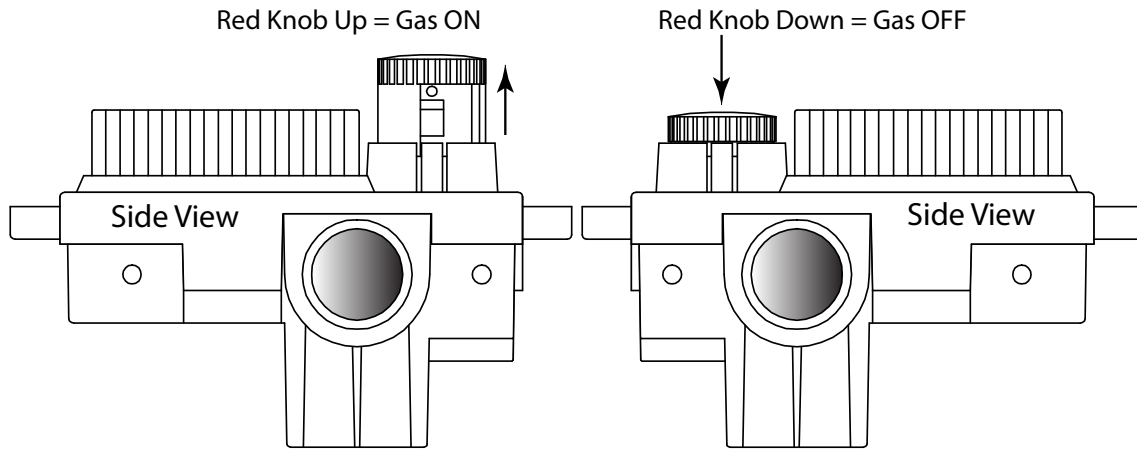

Fig. 5 E-Stop Gas Timer red knob positions

TROUBLESHOOTING

Symptom	Remedy
No gas flow	<ol style="list-style-type: none"> 1. Rotate dial beyond the "turn past" position. 2. Ensure red knob is protruding outward in ON position. 3. Has time has expired on timer? If so re-start timer again. 4. Ensure primary gas supply is turned ON. 5. Ensure the gas timer is plumbed properly. 6. Look for any physical damage. 7. Ensure other gas valves before or after the timer are operating. 8. Check inlet mesh screen for debris blockage.
Gas flow won't stop	<ol style="list-style-type: none"> 1. Timer plumbed backwards? Check inlets and outlets on timer. 2. Excessive gas pressure exceeding the ½" PSI maximum pressure. 3. Plumbed into both inlet lines and not one of the outlets. 4. Look for any physical damage. If so, replace timer.

Limited Warranty

TOP warrants the 1-Hour Gas Timer with E-Stop for 12 months from the date of purchase to the original purchaser to be free from defects in materials and workmanship. It is designed for INDOOR OR OUTDOOR USE. Damage to the 1-Hour Gas Timer with E-Stop caused by accident, misuse, abuse, or installation error, whether performed by a contractor, Service Company, or owner, is not covered by this warranty. TOP will not be responsible for labor charges and/or damage incurred in installation, repair, replacement, or for incidental or consequential damage. Some states, provinces, and nations do not allow exclusion or limitations of incidental or consequential damages, so the above limitations or exclusions may not apply. This warranty gives you specific legal rights. You may also have other rights that vary by state, province, or nation.



The Outdoor Plus Co, Inc
 235 East Main St
 Ontario CA 91761

Phone: 909-460-5579
 Fax: 909-460-5530

www.TheOutdoorPlus.com
www.TopFires.com