

# SENCOR®

SWK 0930WH  
SWK 0931BK



## DOUBLE WALL ELECTRIC KETTLE

Translation of the original manual



**SENCOR®**

**SWK 0930WH  
SWK 0931BK**



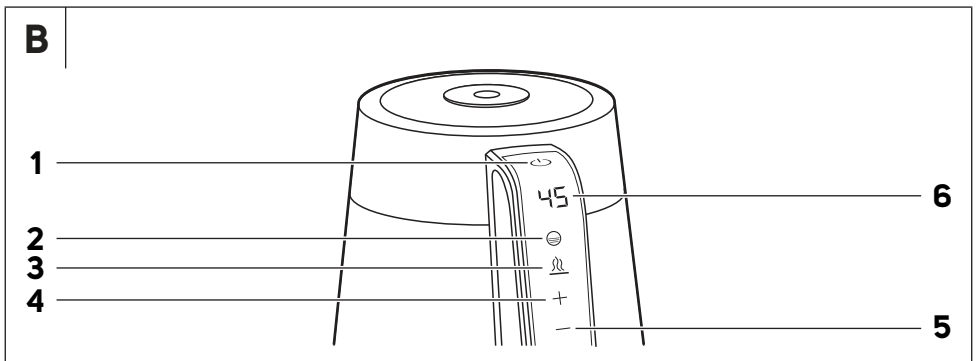
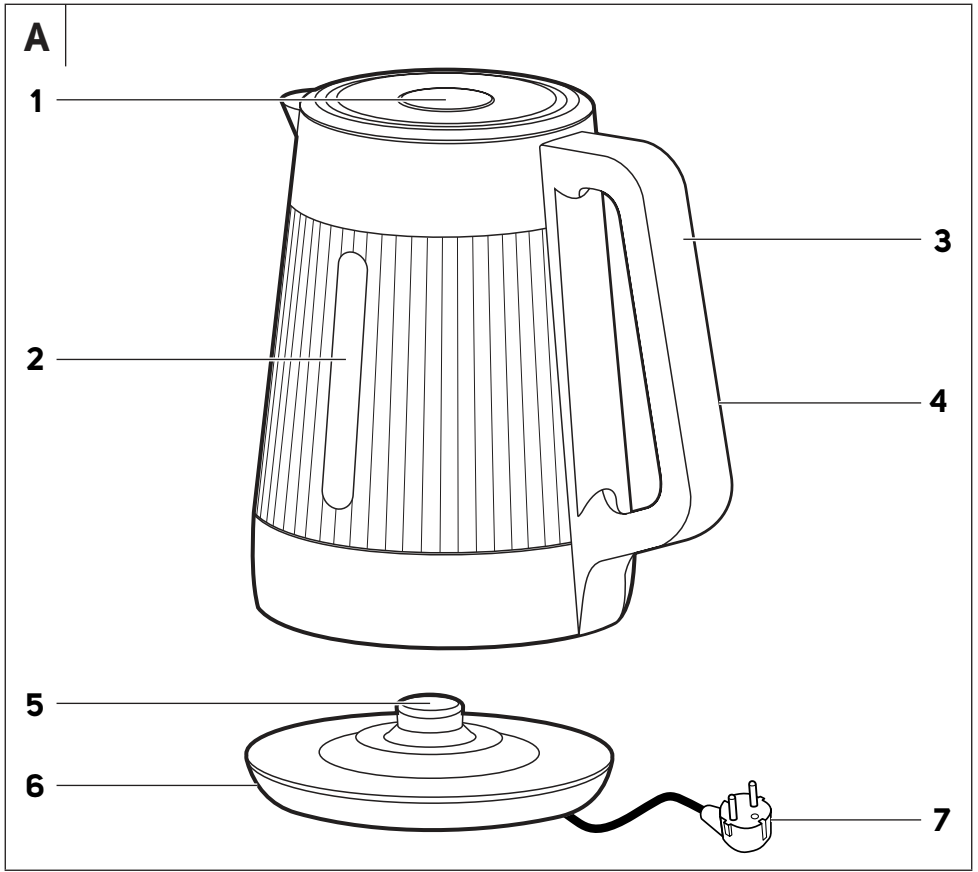

# EN Double wall electric kettle

## Important safety instructions

### READ CAREFULLY AND STORE FOR FUTURE USE.

#### General warnings

- This appliance may be used by children 8 years of age and older and by persons with physical, sensory or mental impairments or by inexperienced persons, if they are properly supervised or have been informed about how to use the product in a safe manner and understand the potential dangers.
- Children must not play with the appliance.
- Cleaning and maintenance performed by the user must not be performed by children unless they are older than 8 years of age and under supervision.
- Keep the appliance and its power cord out of reach of children younger than 8 years of age.
- In the event that the power cord is damaged, have it repaired at a professional service centre to prevent causing a dangerous situation. It is forbidden to use the appliance if it has a damaged power cord.
- This appliance is designed for domestic use and similar locations such as:
  - kitchens in stores; offices and other workplaces;
  - in agriculture;

- for guests of hotels, motels and other similar locations;
- in bed and breakfast establishments;
- Only use the appliance with the supplied base stand.
- Never wash the appliance under running water or submerge it in water or another liquid.
- If the electric kettle is overfilled, then boiling water could splash out.



**WARNING**

Do not open the lid of the kettle when it is running and while water is boiling.

If the lid position can be adjusted, always locate it so that the steam flows away from the handle.

- Make sure that no water or any other liquid splashes on the power plug or the power socket, and that the hot steam emitted from the appliance is also kept away. If this, nevertheless, occurs, disengage the circuit breaker of the power socket and then carefully dry the power socket and the power plug before further use.
- Ensure that no water or any other liquid enters the base stand and in particular its central connector. If this occurs;, disconnect the base stand from the power socket and wipe it dry.



**Attention:**

Make sure that the appliance is turned off before removing it from the base stand.

- The surfaces of the appliance that come into contact with food must always be cleaned according to the instructions in this user's manual.



### **Warning:**

Incorrect use may lead to injuries.

- The surface of the heating element retains residual heat after use.



### **Attention:**

Hot surface.



#### **Electrical safety**

- Before connecting this appliance to an electrical power socket, make sure that the voltage stated on its rating label corresponds to the voltage in your power socket.
- Connect the appliance only to a properly grounded socket. Do not use an extension cord.
- This kettle is not designed to be controlled using a programmed device, external timer switch or remote control.
- Fully unwind the power cord before use.
- Do not connect and disconnect the appliance's power cord to and from the power socket with wet hands.
- Ensure that the power plug contacts do not come into contact with water or any other liquid. If precisely this happens, carefully dry the power plug before using it again.
- Do not disconnect the appliance from the power socket by pulling on the power cord. This could damage the cord or the el. power socket. Disconnect the power cord from the power socket by pulling on the plug.
- Do not place heavy items on the power cord. Make sure the power cord does not hang over the edge of a table and that it is not touching a hot surface or sharp objects.
- Keep the power cord dry.
- Do not wind the power cord around the appliance.
- Never use the kettle in the near vicinity of a bath, shower or swimming pool.
- If the appliance falls into water, under no circumstances continue using it, but rather hand it over to an authorised service centre for inspection.
- Do not wash the kettle or its base stand under running water and do not submerge it or its base stand in water or another liquid.
- Always disconnect the kettle from the power socket when not using it or before moving or cleaning it.
- Take care not to spill water on to the connector when placing the kettle on to the base stand and when taking it off the base stand.
- Do not repair the appliance yourself or make any adjustments to it. Have all repairs or adjustments of the appliance performed at an authorised service centre. Tampering with the appliance during the warranty period may void the warranty.

#### **Safety during use**

- This electric kettle is intended for household use. Do not use it for commercial purposes or for other purposes for which it is not intended.
- Do not place the kettle on window sills or on unstable surfaces. Always place the kettle on a stable, even and dry surface.
- Do not place the electric kettle on an electric or gas stove or in its vicinity, on the edge of a table or on an unstable surface. Only place the electric kettle on an even, dry and stable surface.
- Do not expose the electric kettle to the outdoor environment, extreme temperatures, direct sunlight, excessive humidity or excessively dusty environments.
- Do not place the electric kettle near heaters, open fires or other sources of heat.
- Only use the kettle with the base stand that was supplied with it. Do not use the base stand supplied with this kettle for other types of kettles.
- Use the kettle only for boiling water.
- Although the kettle is protected against damage caused by accidentally turning it on without water, do not use it empty. Incorrect use may negatively affect its working order and lifetime.
- Always take the kettle off the base stand before filling it.
- Check that the lid is securely closed before starting the kettle. Do not open the lid or handle it in any way while the water is boiling.

- The body of the kettle heats up while water is boiled. Do not touch the hot surface. This could cause skin burns. Use the handle for lifting and carrying the kettle.
- Do not place any items or kitchen utensils (e.g. spoons for stirring and serving food) into the kettle while it is boiling water or maintaining a temperature (depending on the kettle model).
- Pay extra attention when handling a kettle filled with hot water.
- Be especially careful when pouring water out of the kettle to avoid scalding by the boiling water or steam.
- Do not place the kettle on an electric or gas stove or in its vicinity, do not place it in the vicinity of an open fire or an appliance that is a source of heat.
- Clean it according to the instructions in chapter Cleaning and maintenance.
- Do not use the kettle when it is not functioning correctly or after it has fallen on the floor, been submerged in water or is showing visible signs of damage or if leaking. Hand it over to an authorised service centre for inspection or repair.
- Store the appliance in a dry environment.

- Thank you for purchasing a SENCOR brand product and we hope that you will be happy with it.
- Prior to using this appliance, please read the user's manual thoroughly, even in cases, when one has already familiarised themselves with previous use of similar types of appliances. Only use the appliance in the manner described in this user's manual. Keep this user's manual in a safe place where it can be easily retrieved for future use. In the event that you hand this appliance over to somebody else, make sure to also include this user's manual.
- Carefully unpack the appliance and take care not to throw away any part of the packaging before you find all its parts. We recommend saving the original cardboard box, packaging material, purchase receipt and responsibility statement of the vendor or warranty card for at least the duration of the legal liability for unsatisfactory performance or quality. In the event of transportation, we recommend that you pack the appliance in the original box from the manufacturer.
- Place the kettle on the base stand. It will beep, all the indicators on the display will flash and the current temperature will be lit. The symbol  will slowly light up and turn off. The kettle is thereby in stand-by mode, meaning that it is ready for operation.
- Pressing and holding down button  for longer than 3 seconds will turn the kettle off and the symbol  will turn off. To put it back into stand-by mode, it is necessary to lift the kettle off the base stand and then to put it back on again.



### Attention:

If the kettle is not located on the base, the control buttons will not react to being pressed. Lifting the kettle off the base will cancel all previous settings. When the kettle is put back on the base, the kettle will switch to standby mode and is again ready for use. This kettle is not calibrated for scientific or laboratory purposes. The actual water temperature may differ by  $\pm 5^{\circ}\text{C}$  from the set water temperature.

### DESCRIPTION OF THE APPLIANCE

<b>A1</b> Open lid button	<b>A5</b> Central connector
<b>A2</b> Water level mark	<b>A6</b> Base stand
<b>A3</b> Control panel with display	<b>A7</b> Power cord
<b>A4</b> Handle	

<b>B1</b> Turn kettle On/Off	<b>B4</b> Increase temperature value; maximum value is $95^{\circ}\text{C}$
<b>B2</b> Water temperature colour indicator 0- $55^{\circ}\text{C}$ - blue 56- $90^{\circ}\text{C}$ - yellow 90- $100^{\circ}\text{C}$ - red	<b>B5</b> Decrease temperature value; minimum value is $35^{\circ}\text{C}$
<b>B3</b> Maintain temperature function; default temperature is $45^{\circ}\text{C}$	<b>B6</b> Current water temperature indicator

### BEFORE FIRST USE

- Remove all wrapping material from the electric kettle and its base stand.
- Fill the kettle with clean water up to the maximum water mark. Boil the water and empty the contents of the kettle. Repeat this process 2 to 3 times. To boil water, proceed according to the instructions in chapter Operation.
- Clean the outer surface of the kettle, the base stand and the power cord only using a dry wiping cloth. Do not submerge any of these parts in water, do not clean them under running water or place them in a dishwasher.

### STAND-BY MODE

- Set the required power cord length and push it into the groove in the base stand. Place the base stand on a stable, even and clean surface. Connect the power cord plug to a power socket.
- Open the lid by pressing the button on the lid and fill the kettle with the required amount of water. The water level must reach at least the minimum mark but must not exceed the maximum mark. After filling the kettle, properly close the lid.



### Attention:



Never fill the kettle when it is placed on the base stand.

### BOILING WATER



### Attention:

The electric kettle is intended only for heating water. Never heat any other liquids or substance in it. Never start the kettle empty without water. Incorrect use may negatively affect its lifetime. If you accidentally turn on the kettle without water, it will automatically turn off after reaching a certain temperature. The kettle can be used again, once the heating bottom has cooled down.

- To boil water, press button . If no other button is pressed within 3 seconds, the kettle will start heating water to  $100^{\circ}\text{C}$ .
- The colour of the  symbol changes colour based on the current temperature:  
0- $55^{\circ}\text{C}$  – blue  
56- $90^{\circ}\text{C}$  – yellow  
90- $100^{\circ}\text{C}$  – red
- When it reaches the temperature of  $100^{\circ}\text{C}$ , the kettle will turn off automatically.





### Note:



The water heating process can be ended at any time by pressing button  for longer than 3 seconds or by lifting the kettle of the base stand.

- Pour the boiled or heated water into a prepared container, cup or mug. Make sure that the kettle remains in a vertical position when it is carried, particularly if it is filled all the way up to the maximum mark.
- If you wish to refill the kettle, be especially careful when opening the lid to avoid scalding by the escaping steam.
- When you have finished using it, disconnect the power cord from the power socket. Empty the kettle and allow it to cool down.

### BOILING WATER AND MAINTAINING A TEMPERATURE

- Pressing button  and then button  will start heating the water to  $100^{\circ}\text{C}$ . When it has been reached, the maintain temperature function will start. After this time has elapsed, the kettle will turn itself off. If you want to stop the maintain temperature function sooner, press and hold down button  for longer than 3 seconds or lift the kettle of the base stand.

## HEATING WATER TO A GIVEN TEMPERATURE AND MAINTAINING IT

- Pressing button  will start heating the water to the preset value of 45 °C. When it has been reached, the maintain temperature function will start. After this time has elapsed, the kettle will turn itself off.
- If you wish to adjust the default temperature 45 °C, then after pressing button , use the + (plus) and - (minus) buttons. The temperature can be adjusted in the range 35-95 °C. Each time the + or - button is pressed, the set temperature is decreased or increased by 1°C.



### Note:

If you press button  during the water heating or boiling process, the activity will end and the kettle will switch to the maintain set temperature mode.  
The set temperature can be adjusted during the maintain set temperature mode as required.

## CLEANING AND MAINTENANCE



### Warning:

Prior to any cleaning or maintenance, always disconnect the base stand from the power socket and allow the kettle to cool down.

Do not wash the kettle, its base stand or power cord under running water and do not submerge them in water or another liquid.

Do not use solvents, abrasive cleaning products, etc. for cleaning the electric kettle or its base stand. Otherwise, its surface may be damaged.

- To clean the external parts of the kettle, use a dry cloth or a cloth dipped in a weak solution of neutral kitchen detergent. After washing it, wipe the surface with a lightly damp cloth and then wipe dry.
- Wipe the internal parts of the kettle using a soft sponge or clean cloth dipped in clean warm water. Do not use detergents or any other chemical agents on the internal parts. After cleaning the kettle, rinse it out several times with clean water.
- To clean the base stand, use only a dry cloth.

### Removing limescale deposits

- During normal use, substances contained in water accumulate on the appliance to form so-called limescale deposits. These may negatively affect the lifetime of the kettle and ruin the taste and appearance of your beverage, so it is important to regularly remove them based on how frequently the kettle is used.
- When using the kettle at a frequency of 3 to 5 times per day, we recommend to remove water scale deposits:
  - once per month in areas with hard and very hard water;
  - once every two to three months in areas with soft and medium hard water.
- Limescale deposits can be cleaned away using standard available limescale removal products (according to the manufacturer's instructions) or use:
  - 8% white vinegar, generally available in stores. Fill the kettle with 1 litre of water and ¼ litre of vinegar. Bring the solution to a boil and leave it to act in the kettle for 2 hours. Then empty the kettle and before further use, boil clean water in it four to five times.
  - citric acid. Boil 1 l of water in the kettle, into the boiled water, add 30 g of citric acid and allow the solution to act for about 30 minutes. Then empty the kettle and before further use, boil clean water in it four to five times.

## STORAGE

- When you have finished using the kettle and have cleaned it, place it and its base stand in a clean, dry place out of children's reach. Keep the stored kettle and its base stand away from extreme temperatures, direct sunlight and excessive humidity and do not store it in an overly dusty environment.

## TECHNICAL SPECIFICATIONS

Rated voltage range.....	220-240 V
Rated frequency.....	50/60 Hz
Rated power input .....	1,750-2,000 W
Volume .....	1,7 l

Changes to text and technical parameters are reserved.

## INSTRUCTIONS AND INFORMATION REGARDING THE DISPOSAL OF USED PACKAGING MATERIALS

Dispose of used packaging material at a site designated for waste in your municipality.

## DISPOSAL OF USED ELECTRICAL AND ELECTRONIC EQUIPMENT



This symbol on products or original documents means that used electric or electronic products must not be added to ordinary municipal waste. For proper disposal, renewal and recycling, hand these appliances over to determined collection points. Alternatively, in some European Union states or other European countries you may return your products to the local retailer when buying an equivalent new product. Correct disposal of this product helps save valuable natural resources and prevents potential negative effects on the environment and human health, which could result from improper waste disposal. Ask your local authorities or collection facility for more details. In accordance with national regulations penalties may be imposed for the incorrect disposal of this type of waste.

### For business entities in European Union states

If you want to dispose of electrical or electronic equipment, ask your retailer or supplier for the necessary information.

### Disposal in other countries outside the European Union.

This symbol is valid in the European Union. If you wish to dispose of this product, request the necessary information about the correct disposal method from the local council or from your retailer.



This product meets all the basic requirements of EU directives related to it.

