

User Manual

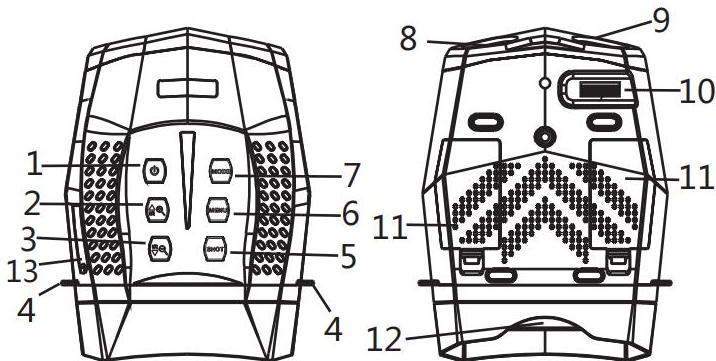

Product Overview



1. Power Button	2. IR Up /Zoom in / Up Button
3. IR Down/ Zoom out / Down Button	4. Strap Hole
5. Shot Button	6. Menu Button
7. Mode Button	8. IR LEDs
9. Lens	10. Focus wheel
11. Battery Cover	12. View Area /display screen

13. USB port/Micro SD card slot Cover

Specification

Photo Resolution: 【3M(2048x1536)】 / 【2M(1600x1200)】 /
【1M(1280x960)】 / 【VGA(640x480)】

Video Resolution: 【1080P(1920x1080P@30FPS)】 /
【960P (1280 x 960 @30FPS)】 / 【VGA(640x480@30FPS)】

Lens: F1.0 larger aperture, f=35mm, Auto IR filter

Lens Angle: 10.3°

Display Screen: Inner screen is 2.5" 640*480 TFT ,

Outer screen: 98x48mm,with 6X large window magnifier

Storage Media: Micro SD card, up to 32GB

USB Port: Micro USB 2.0

Auto off : 3 min/ 5 min/ 10 min/OFF

IR LED: 5W,850nm strong infrared spotlight ,7 grades infrared
adjustment

Display brightness: 7 grades adjustable

View Distance In Complete Darkness: About 600 meters

View Distance In Low Light:1 meters ~ infinity

Digital Zoom: Digital Zoom 4X

Power Source: 8 * 2AA Alkaline battery, External 5V mobile power supply

OSD Language: Multiple languages are optional

Date Stamps : Support to set date and time. Date and time stamp on photo and video files

Operation Buttons: 6 buttons

Operation Temperature: -10°C to +50°C

Storage Temperature: -20°C to +60°C

Dimensions: approx. 196.3*144.6*61.5mm

Weight: about 795g with battery

Install Batteries

- ◆ Please install batteries into the device before using.
- ◆ Open the battery cover on the back of device.
- ◆ Insert 8 x 1.5V AA brand Alkaline batteries into the battery compartment. Make sure the polarity is correct.
- ◆ Close the battery cover.

Inserting Memory Card

- ◆ Please prepare a Class 10 Micro card (up to 32GB) in advance.
- ◆ Open the card slot cover, you will see the card slot.
- ◆ Insert the Micro SD card into the slot. Make sure the direction is right. Never insert the card forcibly.
- ◆ Format the Micro SD card, this can improve the compatibility of Micro SD card.
- ◆ To remove the card from the memory card slot of the device, press the edge of the memory card in gently, the card will pop out. Then remove the card.

Note: If the TF card is not inserted or the card is not inserted correctly, the prompt icon of SD card and the number of photos or recording time will not appear on the screen when the machine is turned on. When pressing the shoot button, the prompt of "No card" will appear.

Basic operation

➤ Turn On And Turn Off



Long press the POWER button for 3 seconds to turn on the device.

Long press the POWER button to turn off the device.

Watch the eyepiece/display screen and adjust the focus wheel according to the actual distance to focus until the screen is clear. If the light is insufficient or used in the evening, turn on the IR by pressing the IR Up/Zoom in/Up Button. Increase the brightness by pressing the button repeatedly. It has 7 levels of brightness (0) 1) 2) 3) 4) 5) 6) 7) 0...) The brightness can be adjusted according to your needs. Long press IR up to zoom.

➤ **Changing The Modes**



The night version has 3 different modes : photo mode, video mode and playback mode. Press the Mode button can change mode.

	Photo Mode	For taking still photos.
	Video Mode	For recording video.
	Playback Mode	For playing the recorded files.

➤ **Taking pictures**

1. Turn on the device, the default is Video mode. Please press the Mode button to switch to photo mode.

2. Zooming:

Keep pressing the  or  button to zoom in or zoom out the image. the value of magnification level appears on the LCD screen.

3. Take a still photo.

- View your subject via the LCD screen.

-Adjust the focus by turning the focus wheel.

For night or insufficient light use,turn on the IR by pressing the IR Up/Zoom in/Up Button.Increase the brightness by pressing the button repeatedly.It has 7 levels of brightness(0) 1) 2) 3) 4) 5) 6) 7) 0...)The brightness can be adjusted according to your needs.

- Press the Shot button to take a photo.

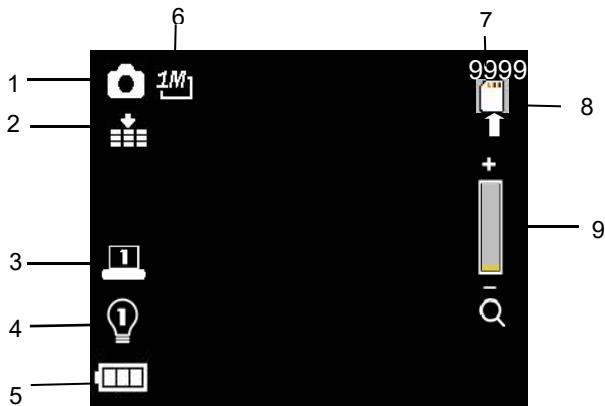

1.	Camera mode	2.	Default high quality images
3.	Screen brightness gear	4.	Infrared light gear
5.	Battery status	6.	Photo Resolution
7.	Number of pictures that can be taken	8.	SD card prompt
9.	Digital zoom indication		

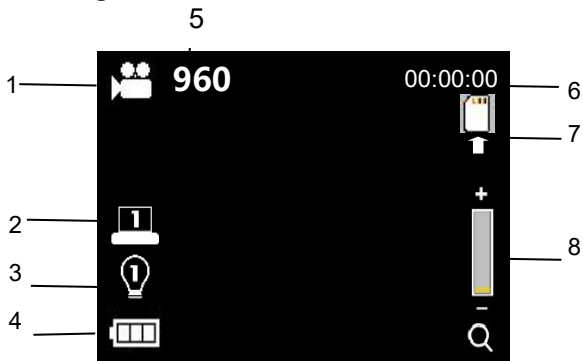

➤ Recording Video



1.	Video mode	2.	Screen brightness gear
3.	Infrared light gear	4.	Battery status
5.	Video Resolution	6.	Number of pictures that can be taken
7.	SD card prompt	8.	Digital zoom indication

1. Turn on the device,the default is Video mode. If not, press the Mode button to switch to Video mode.

2. Zooming:

3. Keep pressing the  or  button to zoom in or zoom out the image. The value of magnification level appears on the LCD screen.

4. Start to record video.

5. - View your subject via the LCD screen.

6. -Adjust the focus by turning the focus wheel

7. For night or insufficient light use,turn on the IR by pressing the IR button.Increase the brightness by pressing the button repeatedly.It has 7 levels of brightness(0) 1) 2) 3) 4) 5) 6) 7) 0...)The brightness can be adjusted according to your needs,darker and need adjusted more brightness.

8. - Press the Shot button to start to record.The record duration will

be shown on the LCD screen.

9. Finish recording.

10. - Press the Shot button again to stop recording.

11. - The device will stop recording automatically once capacity of the memory card is full.

Notice:

➤ **Device Power Off**

If the device fails to activate, check for defective, missing or improperly-installed batteries. Replace or install batteries correctly. Please make sure to use only 8x AA Alkaline batteries.

➤ **Poor Image**

- ◆ If you wear glasses, please keep them on while using the device.
- ◆ If at day, make sure the IR is off (if IR is on, screen is black and white or the screen is colored)
- ◆ If at night, make sure you have turned on the IR, press IR up (if IR is on, screen is black and white).

- ◆ Adjust the focus by slowly turning the Focus wheel . Make sure it is focused.

IR – LED (Night vision function)

1. Regarding manual focusing: users can manually focus the focus wheel according to the actual observation distance to debug the best focus until the display is clear.
2. The video is silent.
3. In photo/video mode, if you have to view the darkness environment, please short press IR UP button to activate the IR LED, the image will change to black and white. The IR LED have seven levels, short press IR UP button to up the level, short press IR DOWN button to down the level.
4. Note: If the battery voltage is not enough, the IR LED level will down automatically. IR level can up to 7 levels when the battery power is full.
5. If only left half power, the level just can up to 5. If only left 25% power, the level just can up to 3. If the battery power is lower than 25%, IR LED cannot be activated.

➤ **Settings in Photo and Video Mode**

Press Menu button in photo or video mode, can change the settings.

Menu	Function
Photo Resolution	Set the photo resolution. Options:[3M(2048x1536)]/[2M (1600 x 1200)] / [1M 1280x960] / [VGA 640x480]
Video Size	Set the video resolution. Options:[FHD 1920X1080]/[960 1280x960]/ [640 640x480].
Night vision sensitivity	Choose the night vision sensitivity. Options:[Low] / [Middle] / [High].
Burst	Options:[Off]/[On]
Lcd Bright	User can according to their need to adjust the brightness of the Lcd screen. Options:[Level 7] / [Level 6] / [Level 5] / [Level 4]/[Level 3]/[Level 2]/[Level 1].

Power Frequency	Set the light source frequency to match frequency of electricity supply in local region to prevent interference. Options:[50Hz]/[60Hz].
Power Save	Set the time to shut down the device for power saving if the device is idle. Options:[3min]/[5min]/[10min]/[OFF].
Date&Time	Set the date and time of device.
Date Stamp	Add the date stamp on the photo or video files. Options:[Off]/[Date]/[Date&Time].
Language	Set OSD (on-screen) language. Options:[English] / [Simplified Chinese]/ [Traditional Chinese] / [Francais] / [nederlands] /[Espanol] / [Italiano] / [Portugues] / [Deutsch]/ [Pyccknn]/ [Japanese]/ [Korean].
Format	Format your TF card. Format TF card will delete all files including the protected files. Please copy the important files before confirm. Options: [Yes] / [No].

Reset All	Restore the setup to factory default settings. Options: [Yes] /[No].
FW Version	User can see the firmware version information.

➤ **Playback**

1. Turn on the device, press the Mode button to switch to playback mode.

2. Press Up/Down button to view photos and video files.

3. Playback the video

- Press the Shot button to start playing the video files.

- Press the Shot button again to have a pause.

- Press Menu button to stop the current video playing.

Press Menu button in playback mode, the screen will display the playback menu. Press Up/Down button to scan lock or delete. And press Shot button to select one to enter the sub-menu.

Playback menu list :

Menu	Function
Lock	Lock or unlock the current one file or all files in memory card. Options: [Lock/Unlock one]/[Lock All]/ [Unlock All].

Delete	Delete the current one file or delete all files in memory card.Options:[One]/[All].
--------	---

Download files to PC

There are two ways to download files from the device to a computer:

- By inserting the memory card into a card reader.
- By connecting the device to a computer using the supplied USB cable.

Using a Card Reader

1. Eject the memory card from the device and insert it into a card reader.Then connect the card reader to a computer.
2. Open [My Computer] or [Windows Explorer] and double-click the removable disk icon that represents the memory card.
3. Copy images from the card into a directory of your choice on the computer's hard disk.

Connecting the Device to a PC through the USB Cable

1. Turn on the night vision. Connect it to a computer through the supplied USB cable.

2. When connecting to the computer, it will appear "MSDC" on the screen.
3. Open [My Computer] or [Windows Explorer]. A "Removable Disk" appears in the drive list. Double-click the "Removable Disk" icon to view its contents. Files stored on the camera are located in the folder named "DCIM".
4. Copy the photos or files to your computer.

NOTES on Cleaning

Before cleaning the device, disconnect it from the power supply (remove batteries)! Only use a dry cloth to clean the exterior of the device. To avoid damaging the electronics, do not use any cleaning fluid. Clean the eyepieces and/or lenses only with a soft, lint-free cloth, (e.g. microfibre cloth). To avoid scratching the lenses, use only gentle pressure with the cleaning cloth. Protect the device from dust and moisture. Store it in a bag or box. Remove the batteries from the device if it is not used for a longer time

