



INSTALLATION GUIDE  
AND USER MANUAL

**Sol-Ark 18K-2P-LV**

**LIMITLESS 18K-2P-LV**

RESIDENTIAL  
NORTH AMERICA

Effective Date: March 3, 2026

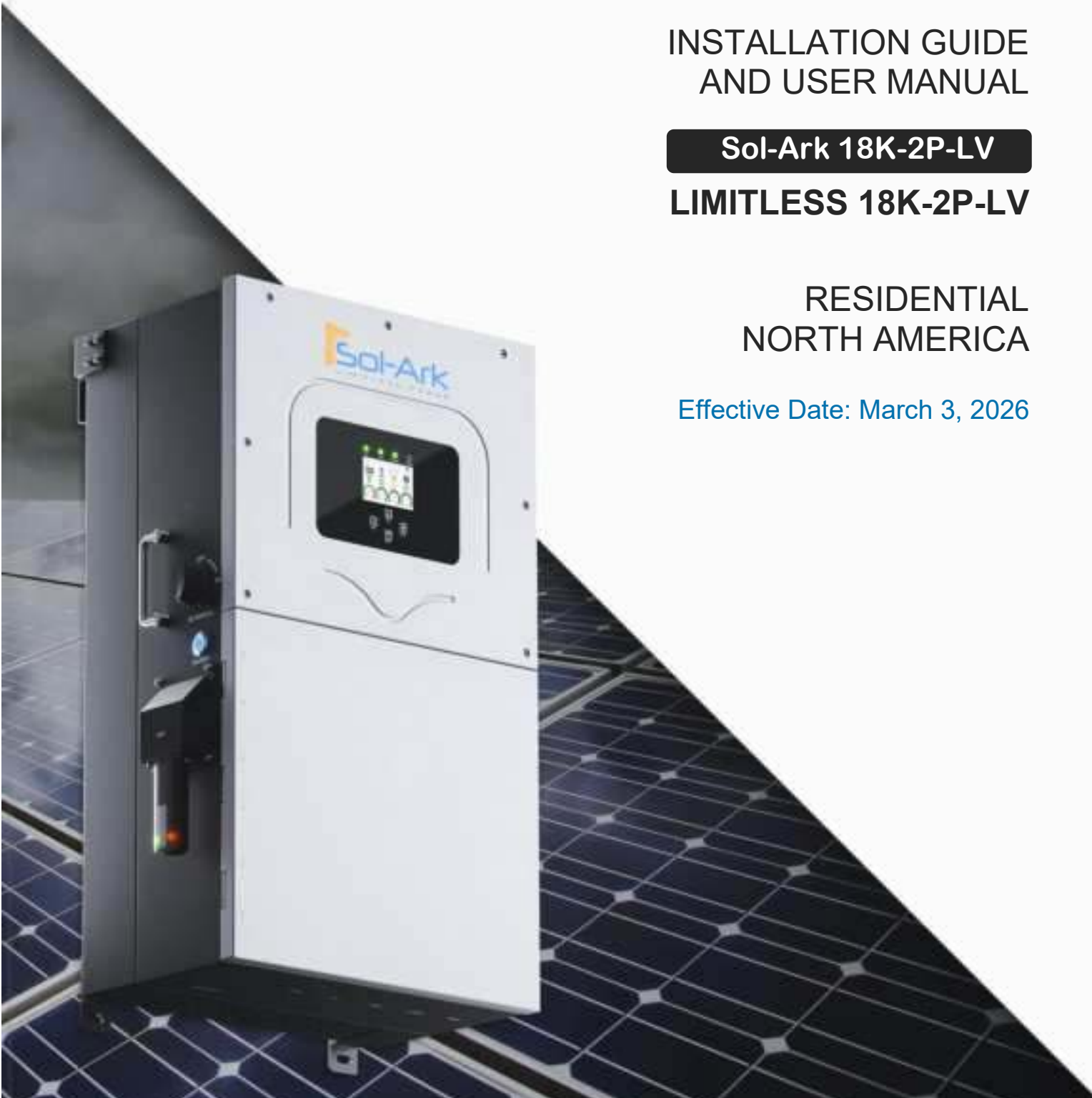

## TMI? Check out the 18K QuickStart Guide.

- The new [18K QuickStart Guide](#) provides the essential steps for installing your Sol-Ark inverter, with links to more detailed information.
- This **18K Installation Manual** provides complete details about your Sol-Ark 18K-2P-LV Inverter, MySolArk, and more.



### READ THE INSTRUCTIONS COMPLETELY BEFORE OPERATING THE EQUIPMENT



- Check the utility voltage before turning ON the unit.
- Verify the inverter's programmed grid type before connecting to the utility.
- The unit is programmed in 120/240V Split-Phase at 60Hz by default.
- Disregarding these instructions could result in permanent damage to the unit.

Information included in this Installation Guide speaks only as of the Effective Date and is qualified, in its entirety, by the Disclaimer referred to below and by the terms of any applicable Limited Warranty.

Sol-Ark reserves the right to make product modifications at any time without advance notice, which may affect information included in this Installation Guide or otherwise make this information inapplicable and out-of-date.

For the latest Sol-Ark product and installation documents, visit: [sol-ark.com](https://sol-ark.com)

For errors, omissions, or suggestions, contact [support@sol-ark.com](mailto:support@sol-ark.com)



# Disclaimer

## **UNLESS SPECIFICALLY AGREED TO IN WRITING BY SOL-ARK IN A VALIDLY EXECUTED AND DELIVERED CONTRACT:**

Sol-Ark assumes no responsibility or liability for any damages, property loss, personal injury, or any adverse consequences resulting from improper use or installation of the product or the failure to adhere to the guidelines provided in this Installation Guide. Users are expressly advised to follow the instructions and guidelines outlined in the documentation accompanying the product. Sol-Ark is not be liable for any damages or losses incurred as a result of, or related to, any failure to comply with, or deviations from, recommended usage, installation, or maintenance procedures. By using the product, users acknowledge their understanding of these disclaimers and agree to use the product at their own risk. Sol-Ark reserves the right to update or modify product information, specifications, and guidelines without prior notice.

This Installation Guide is provided "as is," without charge, and is intended solely for general informational purposes without any right or presumption of reliance. Your sole and exclusive remedy for any defects, or other issues associated with, or related to, any Sol-Ark product is limited and restricted solely to the Limited Warranty provided by Sol-Ark and included in any documentation provided by Sol-Ark or otherwise made available by Sol-Ark, whether through its website or otherwise. Failure to use the most recent, commercially available version of Sol-Ark software, including firmware, may void your warranty and may cause the performance or compatibility of your Sol-Ark product to be adversely affected. You are urged, at all times, to use the most recently available Sol-Ark software, including firmware, for any Sol Ark product, including all updates, upgrades, and other modifications of that software, including firmware, made commercially available by Sol-Ark.

This Installation Guide is not intended to, and does not, supersede any instructions or directions that you may have received from the manufacturer of any other products that you may use in combination with a Sol-Ark. Sol-Ark makes no representation regarding energy system designs within which Sol-Ark products may be used, the use or integration of third party hardware or software, including firmware, with Sol-Ark products, or necessary compliance with local rules or regulations. Changes to non-Sol-Ark manufactured products, including to software, including firmware, or hardware components of those third-party products, may have a material effect on the performance of Sol Ark products and could void applicable warranties or otherwise harm the performance of Sol-Ark products. To the fullest extent permitted by applicable law, Sol-Ark hereby expressly and unconditionally disclaims liability for any and all indirect, incidental, exemplary, punitive or consequential damages.

If you are uncertain about implementing or using any of the information contained in, or made available by, this Installation Guide, you are urged not to continue with this Installation Guide and immediately to contact Sol-Ark Technical Support. This Installation Guide does not modify, extend or change the terms of any Limited Warranty that may be applicable to your Sol Ark products, and you should carefully consult those Limited Warranty terms to ensure that you may not be voiding or violating those Limited Warranty terms if you undertake any of the actions referred to in this Installation Guide.

Sol-Ark retains the right to final interpretation of this document and all related materials pertaining to this product. This document is subject to modifications, updates, revisions, or termination without prior notice. For the latest product information, please visit Sol-Ark's official website. [www.Sol-Ark.com](http://www.Sol-Ark.com)

Any action related to the information included in this Installation Guide shall be governed by the internal laws of the State of Texas, United States of America, without giving effect to any conflicts of laws principles. Any action, suit, or other legal proceeding that is commenced to resolve any matter related to this Guide shall be commenced solely and exclusively in a state court sitting in Collin County, Texas (or, if appropriate, a federal court located within Collin County in the Eastern District of Texas), and you hereby consent to the personal jurisdiction of those courts. This manual is for use only with the **Limitless 18K-2P-LV Hybrid Inverter**, as commercially available on the Effective Date of this Guide.

### **For support, contact:**

(USA) +1 (972) 575-8875 ext. 2

[support@sol-ark.com](mailto:support@sol-ark.com)

# Contents

|  |    |
|--|----|
| Before You Start.....  | 1  |
| 1. Sol-Ark At First Glance.....                                  | 2  |
| Inspect shipment .....   | 2  |
| Components.....  | 2  |
| 1.1 Components and Inputs .....                                  | 3  |
| 1.2 Specifications.....  | 3  |
| 1.3 Connection Requirements .....                                | 6  |
| 2. Installation.....   | 8  |
| Backup Circuits.....   | 8  |
| Single System Install .....                                      | 8  |
| 2.1 Mounting the Sol-Ark .....                                   | 9  |
| 2.2 Integrating Batteries .....                                  | 11 |
| 2.3 Battery Communication.....                                   | 13 |
| 2.4 Connecting PV Modules.....                                   | 14 |
| 2.5 Integrating a Generator .....                                | 16 |
| 2.6 Grid Peak Shaving.....                                       | 17 |
| 2.7 Automatic Generator Start .....                              | 17 |
| 2.8 Integrating Sensors and Accessories.....                     | 18 |
| 2.9 Limit Sensors (CT sensors).....                              | 23 |
| 2.10 Emergency Stop and Rapid Shutdown .....                     | 26 |
| 2.11 Powering-Up the Sol-Ark.....                                | 28 |
| 2.12 Power Cycle Sequence .....                                  | 30 |
| 3. User Interface .....  | 31 |
| 3.1 LED Indicators .....   | 31 |
| 3.2 Main Menus .....   | 32 |
| 3.3 Basic Setup .....  | 34 |
| 3.4 Battery Setup.....   | 36 |
| 3.5 Limiter.....   | 39 |
| 3.6 Grid Setup .....   | 46 |
| 4. Installation Tips.....  | 48 |
| 4.1 Off-Grid Installation Tips.....                              | 48 |
| 4.2 Grid-Tie and No Battery Install Tips (Passthrough mode)..... | 48 |
| 4.3 Battery Charge Controller .....                              | 49 |
| 4.4 Local Grid Compliance Settings .....                         | 49 |
| 5. Parallel Systems.....   | 50 |
| 5.1 Before Enabling Parallel Operations .....                    | 50 |
| 5.2 Parallel Systems Programming Sequence .....                  | 53 |
| 5.3 Three-Phase Systems .....                                    | 55 |



|   |    |
|---|----|
| 6. MySolArk: Remote Monitoring .....  | 57 |
| 6.1 Setting Up MySolArk .....   | 57 |
| 6.2 LED Indicator and troubleshooting .....   | 63 |
| 7. Wiring Diagrams .....  | 64 |
| 7.1 Standard Wiring Diagram .....   | 65 |
| 7.2 Standard Wiring Diagram – <b>Line Side Tap</b> .....                                | 66 |
| 7.3 Standard Wiring Diagram – <b>AC Coupling in GEN</b> .....                           | 67 |
| 7.4 Standard Wiring Diagram – <b>AC Coupling in LOAD</b> .....                          | 68 |
| 7.5 Standard Wiring Diagram – Whole-Home Generator .....                                | 69 |
| 7.6 Standard Wiring Diagram – <b>Off Grid</b> .....                                     | 70 |
| 7.7 Standard Wiring Diagram – Bypass Transfer Switch .....                              | 71 |
| 7.8 Standard Wiring Diagram – 2 Parallel Inverters   120/240V .....                     | 72 |
| 7.9 Standard Wiring Diagram – 3 Parallel Inverters   120/240V .....                     | 73 |
| 7.10 Standard Wiring Diagram – 2 Parallel Inverters   120/208V Unbalanced 3-Phase ..... | 74 |
| 7.11 Standard Wiring Diagram – 3 Parallel Inverters 120/208V .....                      | 75 |
| 8. Troubleshooting Guide .....  | 76 |
| 8.1 Sol-Ark Error codes .....   | 78 |
| 9. Warranty Verification Checklist.....   | 79 |
| 10.GUI Screens.....   | 80 |

# Important Safety Instructions

This manual provides crucial information for installing and operating the Sol-Ark 18K-2P Hybrid Inverter System. Qualified and authorized personnel are required to perform the installation and maintenance procedures adhering to all safety standards and system requirements outlined in this document. Sol-Ark assumes no responsibility for damage caused to a Sol-Ark product by unauthorized or unqualified personnel.

This manual is applicable to countries that comply with the certification requirements. Standards and legal requirements of other countries might differ from the specifications outlined in this manual.

## Symbols in this Document



**WARNING:** This symbol indicates information that, if ignored, could cause serious injury, equipment damage, or death.



**CAUTION:** This symbol indicates information that, if ignored, could result in minor injury or equipment damage.



**NOTE:** This symbol indicates relevant information that is not related to hazardous situations.

## Symbols on the Equipment



**CAUTION:** Indicates risk of injury or equipment damage.



**RISK OF ELECTRIC SHOCK:** Indicates components that present risk of electrical shock.



**DO NOT INCINERATE:** Do not dispose of product by incineration.



**RECYCABLE:** Product is recyclable. Proper disposal is required.



**REFER TO INSTRUCTIONS:** Read operating and installation instructions before proceeding.



**TUV:** SGS marking indicates NRTL product testing and certification for compliance with standards for North America and Canada.



**DO NOT THROW AWAY:** Proper disposal of inverters and/or batteries is required.



# Notices

**ATTENTION** Read all instructions and cautionary markings in this document and on the equipment before installing the Limitless 18K-2P-LV inverter. Failing to follow any of these instructions may also void the limited warranty provided by Sol-Ark.

All installations must conform to the laws, regulations, codes and standards applicable in the jurisdiction of installation.

Before starting an installation, consult a local building or electrical inspector for current requirements. Local codes may vary but are adopted and enforced to promote safe electrical installations. A permit may be needed to do electrical work, and some codes may require an inspection of the electrical work. Sol-Ark is not responsible for system design or installation and makes no representations regarding system performance, reliability or compliance with local or other codes or requirements.

When installed in the US, electrical installations are required to follow the National Electrical Code (ANSI/NFPA 70) adopted by their local AHJ (Authority Having Jurisdiction) including any local amendments.

## General

**WARNING:** Risk of electric shock. Risk of fire. Only qualified electrical personnel should install, troubleshoot, service, or replace the equipment.

**WARNING:** Risk of electric shock. Apply appropriate personal protective equipment (PPE) and follow safe electrical work practices during installation and service. Turn off all power supplying this equipment before working on or inside equipment and ensure that no charge remains in the equipment. Always use a properly rated voltage sensing device to confirm power is off. Replace all devices, covers, and doors before turning on power to the equipment.

**WARNING:** Inspect the equipment for damage before installation. Do not install the equipment if it has been damaged in any way.

**WARNING:** Do not insert foreign objects into any part of the equipment.

**WARNING:** Do not expose the equipment or any of its components to direct flame.

**WARNING:** Do not attempt to open, disassemble, repair, tamper with, or modify the equipment other than what is expressly permitted in this manual. The equipment contains no user-serviceable parts. Contact the installer who installed the equipment for any repairs.

**WARNING:** Do not connect life-support systems, other medical equipment, or any other use where product failure could lead to injury to persons or loss of life.

**CAUTION:** Do not use solvents to clean the equipment or expose the equipment to flammable or harsh chemicals or vapors. Do not allow petroleum-based paints, solvents, or sprays to contact nonmetallic parts of the equipment.

**CAUTION:** Do not use parts or accessories other than those specified for use with the equipment.



## Installation and Use

**WARNING:** Risk of electric shock. Risk of fire. Only use electrical system components approved for dry locations.

**WARNING:** Risk of electric shock. Risk of fire. Ensure that all wiring is correct and that none of the wires are pinched or damaged.

**WARNING:** Risk of electric shock. Risk of fire. Before making any connections verify that the DC disconnect(s) are in the off position. Double check all wiring before applying power.

**WARNING:** Risk of electric shock. Improper servicing of the equipment or its components may result in a risk of shock or fire. To reduce these risks, disconnect all wiring before attempting any maintenance or cleaning.

**WARNING:** Risk of electric shock. Always de-energize the equipment before servicing.

**WARNING:** Risk of electric shock. Do not use equipment in a manner not specified by the manufacturer. Doing so may cause injury or loss of life, or damage to equipment.

**CAUTION:** Risk of damage. DO NOT connect the grid to the **LOAD** output terminal.

**CAUTION:** Risk of damage. Do not exceed **500V<sub>oc</sub>** on any MPPT on the Sol-Ark on any MPPT on the 18K-2P-LV.

**CAUTION:** Risk of damage or electric shock. All inverter inputs should only have one conductor connected to them.

**NOTE:** This device complies with part 15 of the FCC Rules. Operation is subject to the following two conditions: (1) This device may not cause harmful interference, and (2) this device must accept any interference received, including interference that may cause undesired operation. Changes or modifications not expressly approved by the party responsible for compliance could void the user's authority to operate the equipment.

## Environmental Conditions

**WARNING:** This equipment is intended for operation in an environment having a minimum temperature of -40°C (-40°F) and a maximum temperature of 60°C (140°F).

**WARNING:** Install the equipment in a location that prevents damage from flooding. Ensure that no water sources are above or near the equipment, including downspouts, sprinklers, or faucet.

## Transportation and Handling

**WARNING:** To protect the equipment and its components from damage when transporting, handle with care. To help prevent damage, leave all equipment in its shipping packaging until it is ready to be installed.

**WARNING:** Risk of physical injury or death. Use caution when using lifting equipment to move battery modules and components.

**WARNING:** Risk of physical injury or death. Boxed battery modules.

## Requirements for Installation Personnel

**All work MUST comply with local code, regulations, and industry standards.** The installation of the 60K-3P-480V can only be completed by qualified people with appropriate qualifications as determined by the local AHJ.



DO NOT exceed **500V<sub>oc</sub>** on any MPPT on the Sol-Ark.

## Before You Start

 Before you start, please note some important considerations about your Sol-Ark Inverter.

### Dimmer Switches

The Sol-Ark inverter is designed to be compatible with most standard dimmer switches; however, compatibility may vary depending on the specific dimmer model and its settings. Light flickering, reduced performance, or improper dimming may occur when used with this inverter.

### AC Coupling Considerations (Off-Grid and Load Side)

While it's possible to connect Utility Interactive Inverters to the Load input of the Sol-Ark, it's not recommended.

Note these limitations:

- The Sol-Ark will not display or report the power production of the connected inverter.
- The Sol-Ark cannot accurately report power consumption by the Loads while the connected inverter is producing power.
- In the event of a utility outage, the Sol-Ark may cut power to loads for several seconds to protect the battery.

# 1. Sol-Ark At First Glance

## Inspect shipment

The box should include all items shown in the component guide. If there is damage or missing parts, immediately call Sol-Ark Technical Support at (972) 575-8875 ext. 2.

## Components

The Limitless 18K-2P-LV system includes the following components:

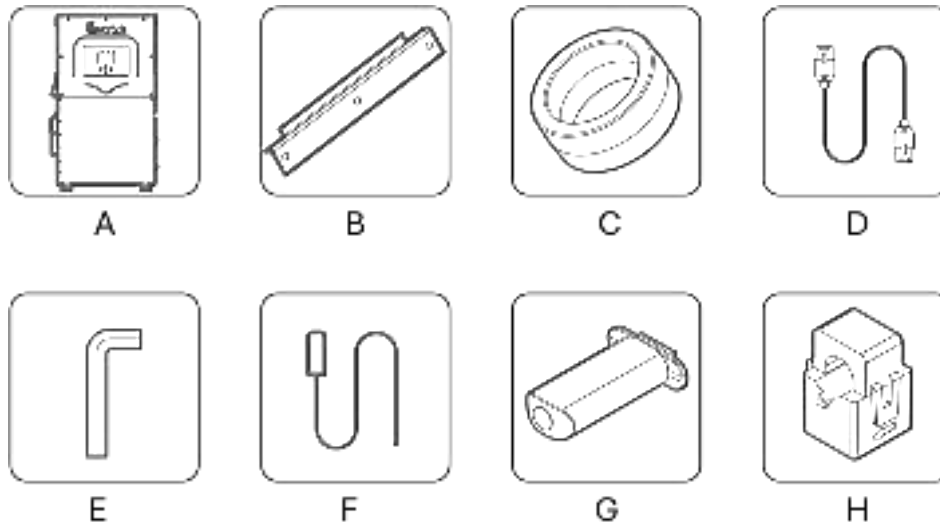

| Component | Description                                      | Quantity |
|-----------|--|----------|
| A         | Sol-Ark Limitless 18K-2P-LV inverter             | 1        |
| B         | French cleat                                     | 1        |
| C         | Filter Rings (see page 19)                       | 10       |
| D         | CAT 5E communication cable                       | 1        |
| E         | Allen keys (4 mm and 8 mm)                       | 1        |
| F         | Temperature sensor                               | 1        |
| G         | Wi-Fi / Ethernet antenna (dongle)                | 1        |
| H         | 300A (Ø1.378") Current transformers (CT sensors) | 2        |

## 1.1 Inverter Components and Inputs

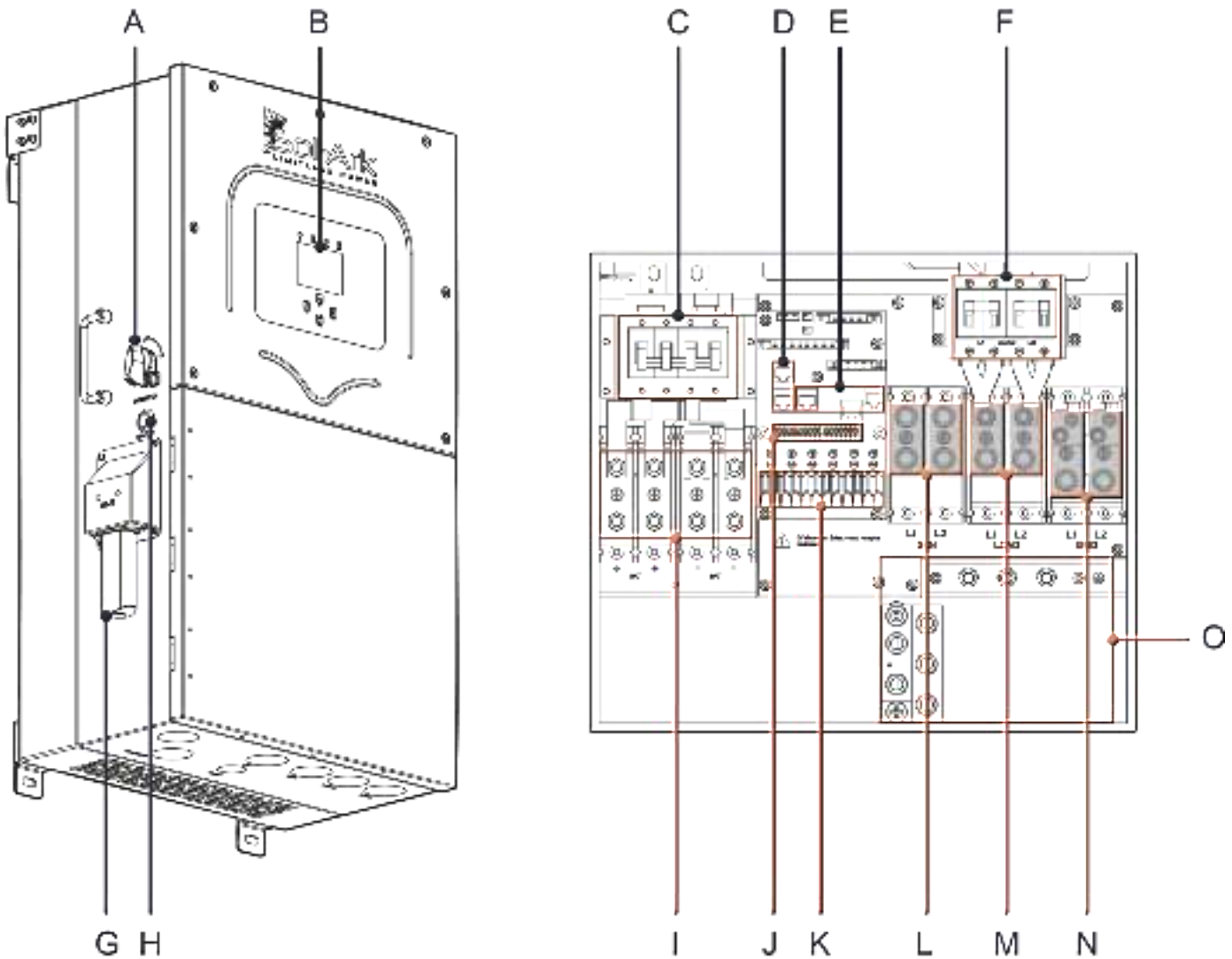

| Component | Name                                    |
|-----------|---|
| A         | PV DC disconnect                        |
| B         | LCD touch screen                        |
| C         | 2x (250A) battery breakers <sup>1</sup> |
| D         | Parallel RJ45 ports                     |
| E         | BMS RJ45 ports (RS485 / CAN)            |
| F         | ((200A) LOAD breaker                    |
| G         | Wi-Fi / Ethernet dongle                 |
| H         | ON / OFF Button                         |

| Component | Name                                      |
|-----------|---|
| I         | Battery terminals                         |
| J         | Input pinouts for sensors and accessories |
| K         | 3x MPPT inputs                            |
| L         | ((150A) GEN terminal                      |
| M         | ((200A) LOAD terminal                     |
| N         | ((200A) GRID terminal                     |
| O         | GROUND / NEUTRAL Busbars                  |

<sup>1</sup> Certain earlier production models were equipped with 200A breakers, and both configurations remain fully compliant with UL certification and applicable regulatory requirements.

## 1.2 Specifications

### Dimensions

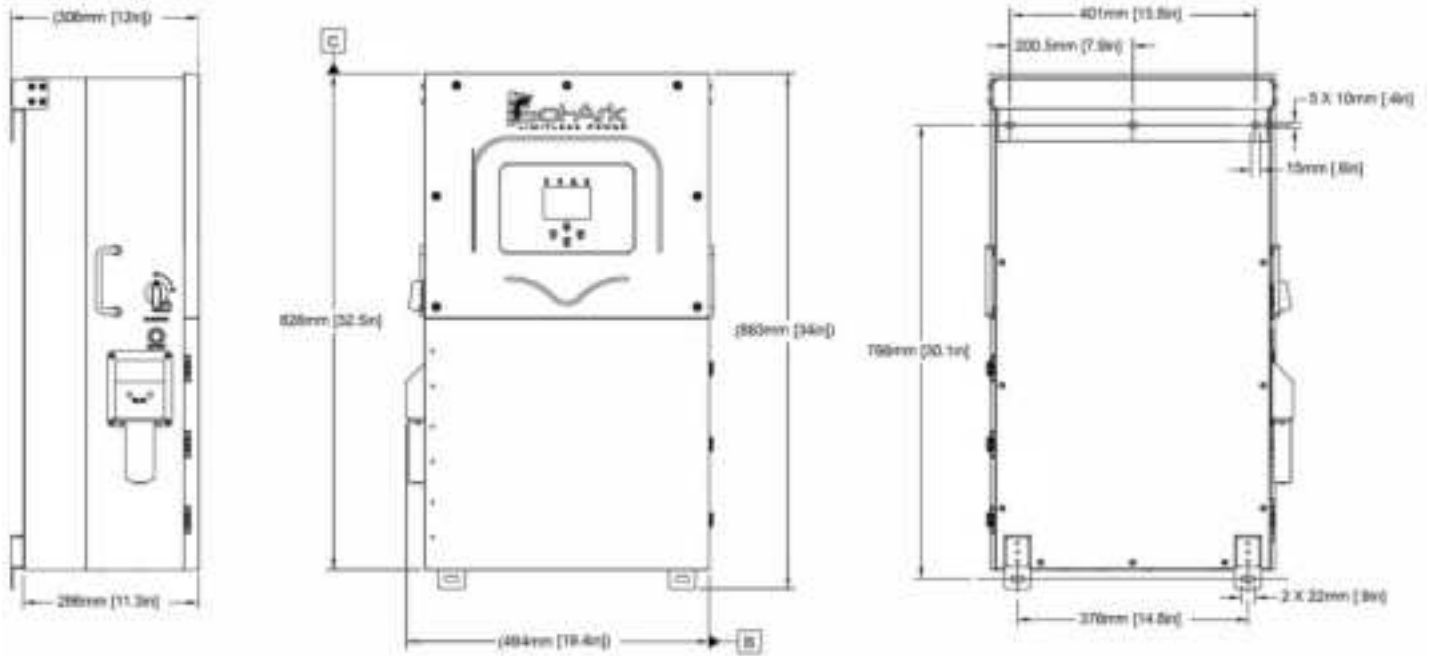

### Knockout View from Bottom of Inverter

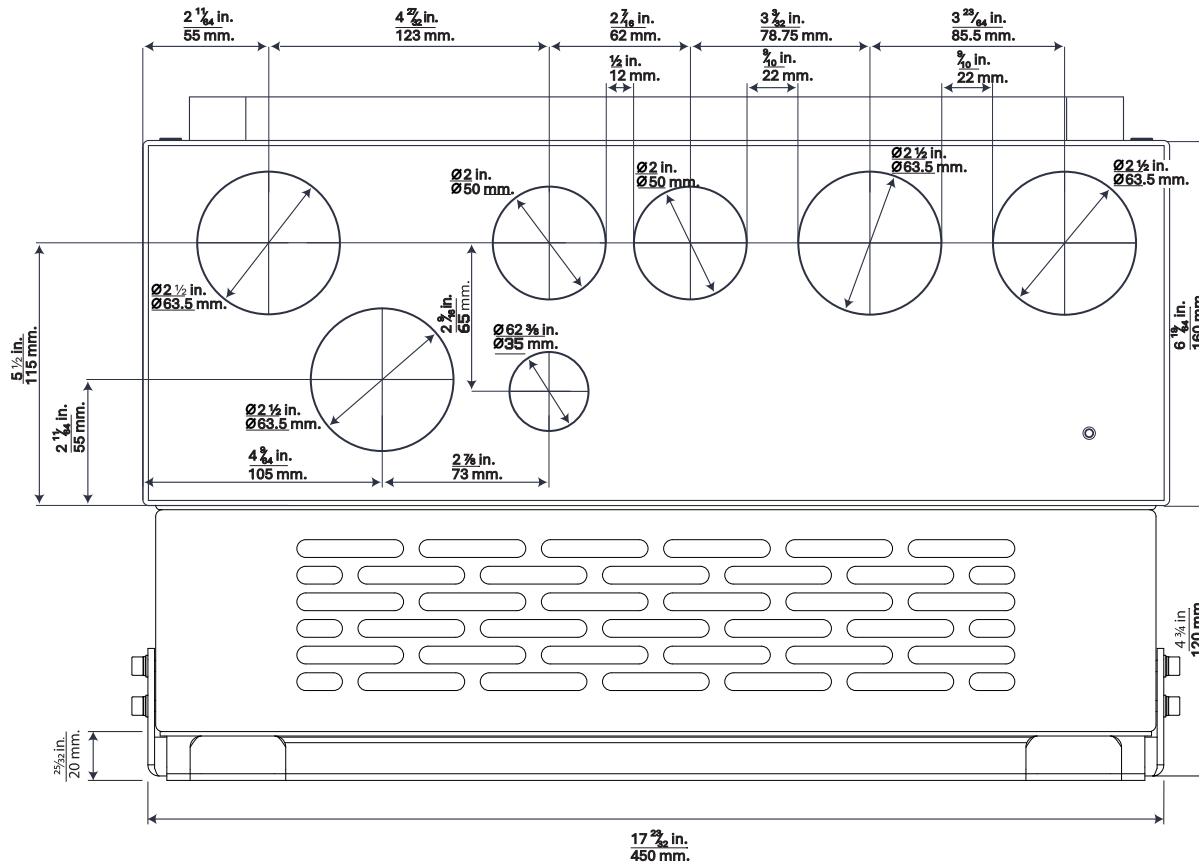

**Cover thickness:** 15/16in [0.937in] or 23.8mm.

## Limitless 18K-2P-LV Residential Hybrid Inverter

SKU: Limitless 18K-2P-LV

| Input Data (PV)                               |  |
|---|--|
| Max. Supported PV Power                       | 32,400W  |
| Max. Usable PV Power                          | 28,800W  |
| Max. AC Coupled Input                         | 28,800W  |
| Rated MPPT Operating Voltage Range            | 150 - 475V   |
| Startup Voltage                               | 121V   |
| Max. DC Input Voltage <sup>1</sup>            | 500V   |
| Max. Operating Input Current per MPPT         | 36A  |
| Max. Short Circuit Current per MPPT           | 54A  |
| No. of MPPT/Inputs                            | 3/2  |
| Output Data (AC)                              |  |
| Continuous Power                              | 18,000W  |
| Surge Power (10s)                             | 36,000W  |
| Grid Frequency                                | 50 / 60Hz  |
| Max. Output Current                           | 75A  |
| Max. Grid Passthrough Current                 | 200A   |
| CEC Efficiency                                | 97.6%  |
| Max Efficiency                                | 97.6%  |
| Stackable                                     | Yes, Max 12  |
| Battery Input Data (DC)                       |  |
| Nominal DC Voltage                            | 48V  |
| Operating Voltage Range                       | 41 - 63V   |
| Capacity                                      | 50 - 9900Ah  |
| Continuous Battery Charge / Discharge Current | 350A   |
| BMS Communication                             | CANBus & RS485 MODBUS  |
| General Data                                  |  |
| Dimensions [H x W x D (mm)]                   | 863 x 464 x 282 mm (34 x 18.2 x 11.1 in)   |
| Weight  | 62.14 Kg / 137 lb  |
| Enclosure                                     | IP65 / NEMA 3R   |
| Ambient Temperature                           | -40 ~ +60°C, > 49°C Derating   |
| Operating Altitude <sup>2</sup>               | 3000 m (9843 ft)   |
| Noise   | < 50 dBA   |
| Standard Warranty                             | 10 Years   |
| Protection and Certifications                 |  |
| Certifications and Listings                   | UL1741 CRD Multimode, UL1741 3rd SB, UL1741 CRD PCS, IEEE1547-2018 and interoperability using IEEE2030.5, Hawaiian Electric SRD V2.0, UL1699B PVDC AFCI, UL1998, CSA C22.2 No. 107 |
| PV DC Disconnect Switch                       | Integrated   |
| Ground Fault Detection — NEC 690.5            | Integrated   |
| AC Output Breaker - 200A                      | Integrated   |
| Surge Protection                              | DC Type II / AC Type II  |

<sup>1</sup> See Installation Manual for more details on sizing array strings. The highest input voltage is based on the open-circuit voltage of the array at the minimum design temperature.

<sup>2</sup> Derating occurs above 3000m (9843 ft).

## 1.3 Connection Requirements

### Limitless 18K-2P-LV Torque Values for Terminals

 Do not use impact drivers to tighten any fasteners on the Sol-Ark

 All wire runs should be sized to be at or below a 2.5% voltage drop at full load. Wire size must comply with your local electrical code.

#### A. Field Wiring

All wire runs should be sized to be at or below a 2.5% voltage drop at full load. Equipment wire sizing must comply with the NEC or local electrical code.

The table below shows the ampacity ratings of the various connection points in the field wiring area of the inverter. Copper conductor is recommended.

| Component | Description                  |
|-----------|------------------------------|
| A         | PV DC disconnect             |
| B         | LCD touch screen             |
| C         | 2x (250A) battery breakers   |
| D         | Parallel RJ45 ports          |
| E         | BMS RJ45 ports (RS485 / CAN) |
| F         | (200A) LOAD breaker          |
| G         | Wi-Fi / Ethernet dongle      |
| H         | ON / OFF Button              |

| Field Wiring Terminal | Description                        | Terminal Rating    | Terminal Wire Size (min-max) | Torque [in-lb] | Torque [Nm] |
|-----------------------|------------------------------------|--------------------|------------------------------|----------------|-------------|
| I                     | Battery terminals                  | 255A <sub>DC</sub> | 2/0 – 4/0 AWG                | 90 in-lb       | 10 Nm       |
| J                     | Inputs for sensors and accessories |                    |                              |                |             |
| K                     | MPPT inputs                        | 41A <sub>DC</sub>  | 12 – 10 AWG                  |                |             |
| L                     | GEN terminals                      | 255A AC            | 6 – 4/0 AWG                  | 165 in-lb      | 18.6 Nm     |
| M                     | LOAD terminal                      | 255A AC            | 1/0 – 4/0 AWG                | 165 in-lb      | 18.6 Nm     |
| N                     | GRID terminal                      | 255A AC            | 1/0 – 4/0 AWG                | 165 in-lb      | 18.6 Nm     |
| O                     | GROUND/NEUTRAL Busbars             | 255A AC            | 6 – 4/0 AWG                  | 121 in-lb      | 13.7 Nm     |

## C. Sensors and Communications Requirements

| Component                   | Wire Size Range  | Max Distance  |
|-----------------------------|------------------|---|
| CT Sensor                   | 18-23 AWG        | 0' – 10' [3 m]: 23 AWG included<br>10' – 150' [50 m]: CAT6 extendable |
| Communications              | 24 – 23 AWG      | 0' – 100' [30 m]: 24 AWG<br>100' – 400' [120 m]: 23 AWG               |
| RJ45 Parallel Communication | CAT 5E or better | 0' – 7' [2.1 m]: Included<br>7' – 20' [6m]: Extendable                |

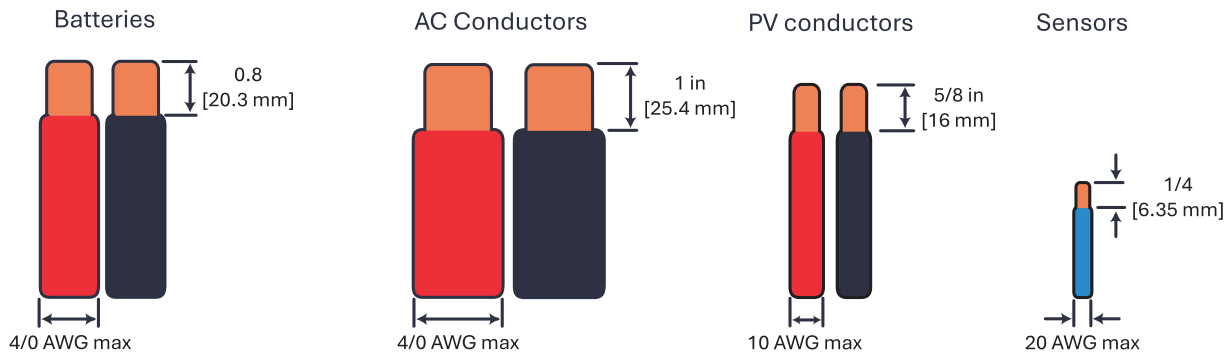

### CT Sensors (Included)

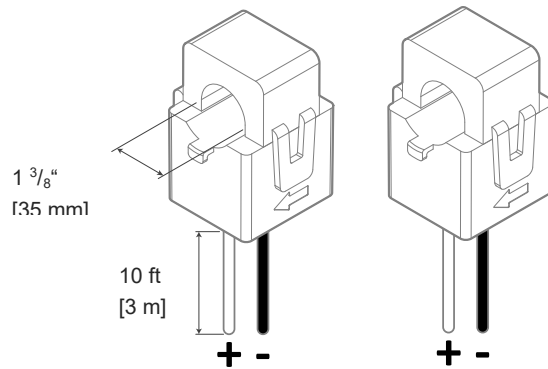

## 2. Installation

### Backup Circuits

A. The **LOAD** connected service panel is called the Essential Loads Panel.

You must keep the Essential Loads Panel within the limitations of the unit:

- Grid Tie > 48 kW = 240V \* 200A max (passthrough)
- Off-Grid > 18KW = 240V \* 75A continuous

B. Verify that every load circuit power ( $P=V*I$ ) does not surpass the limits listed above.

### Single System Install

A. **FOR PARTIAL BACKUP:** Connect the output of the back-feed breaker or line side tap (depending on the point of interconnection) to the **GRID** terminal.

- An external disconnect must be installed between the interconnection and the Sol-Ark. Size the disconnect according to code.
- Connect the **LOAD** output to the Essential Loads Panel. Follow electric code to select proper wire gauge.

B. **FOR WHOLE-BUSINESS BACKUP:** Connect the utility grid directly to the **GRID** terminal.

- An external disconnect must be installed between the grid and the Sol-Ark. Size the disconnect according to code.
- Connect the **LOAD** output to the Main Service Panel. Follow electric code to select proper wire gauge.

It's possible to connect a generator or an AC coupled source (120A max or 28,00W), such as string or micro inverters, to the **GEN** terminal of the inverter. Only one AC source can be connected to the **GEN** terminal at a time.

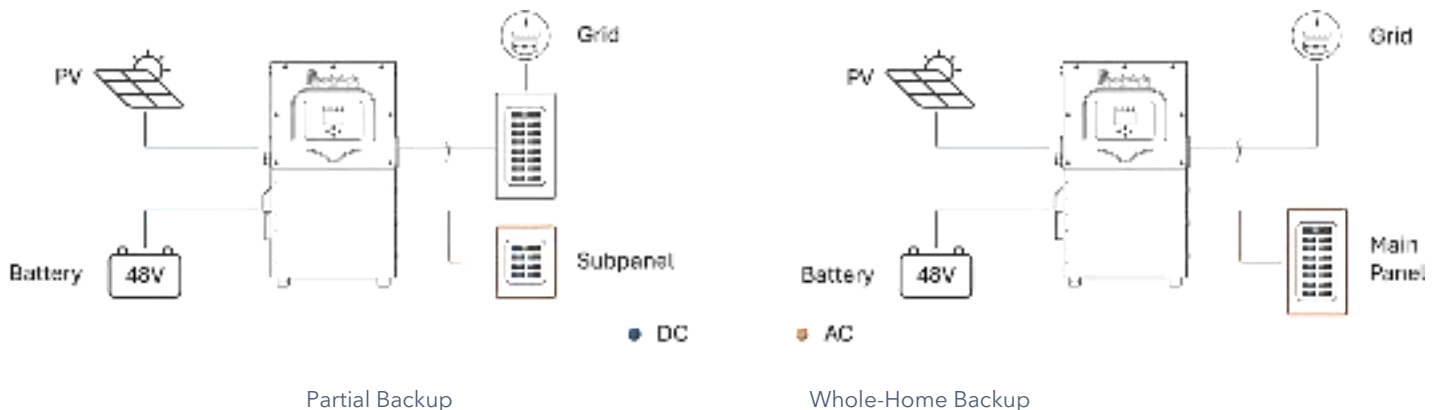

## 2.1 Mounting the Sol-Ark

1. Considering the dimensions of the inverter, find a suitable location for the system. There must be at least 6 in [15 cm] of vertical clearance and 2 in [5 cm] of side clearance for proper heat dissipation.

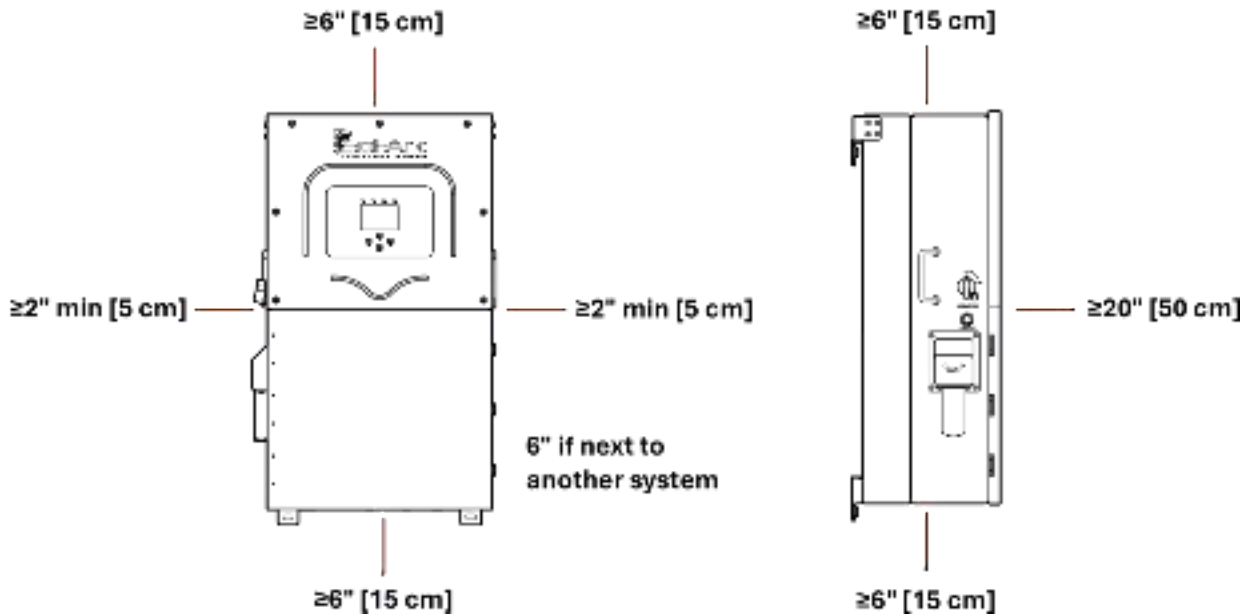

**!** Maximum heat dissipation of 540W

Under certain conditions, the National Electrical Code® specifies greater clearances. Ensure that the prescribed clearances in accordance with the National Electrical Code®, paragraph 110.26 and Canadian Electrical Code® CSA C22.1 are adhered to.

The Limitless 18K-2P-LV is a NEMA 3R - IP65 enclosure that is rated for outdoor installation but can also be installed indoors.

**!** **PROTECT THE LCD SCREEN** from direct exposure to UV light.

2. Use screws or anchors suitable for the support surface and capable of supporting the weight of the inverter (137 lb / 62.14kg).
  - For Concrete or Masonry Mounting: Use a minimum of 5 3/8in expanding anchors (not included).
  - For Wood Frame Mounting: Use a minimum of 5 3/8in lag screws with flat washers, making sure to anchor into at least 2 framing members. (not included)
  - For Metal Framing Mounting: Use a minimum of 5 1/4in self-tapping metal screws with flat washers. (not included)

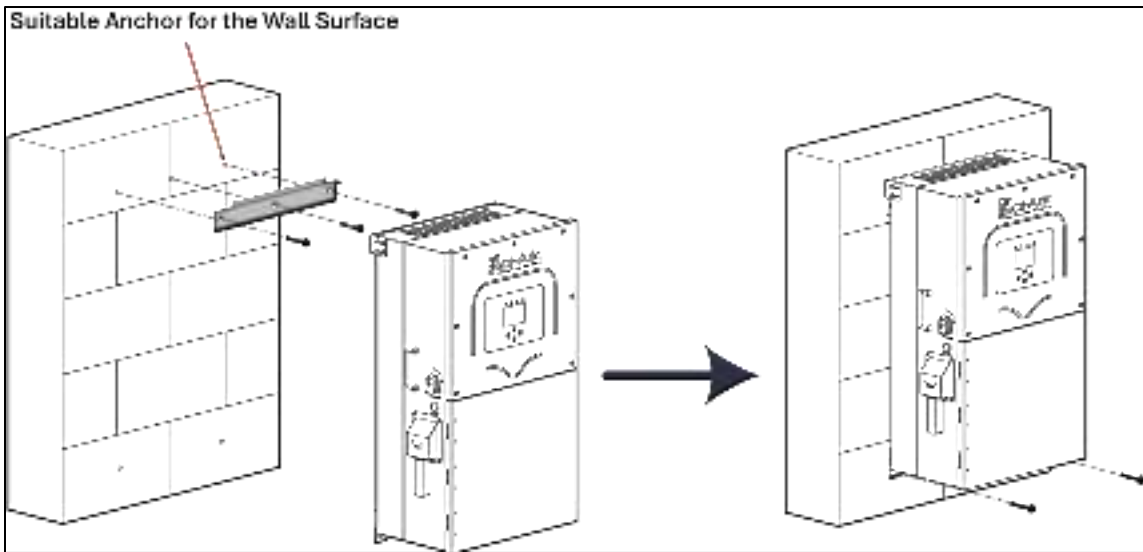

3. In case a different anchorage is required, calculate the support needed to properly hold the weight of the equipment.

Damage to the LCD Screen due to direct sunlight exposure will not be covered by warranty.

4. Mount the inverter in the optimal orientation as shown on the left.

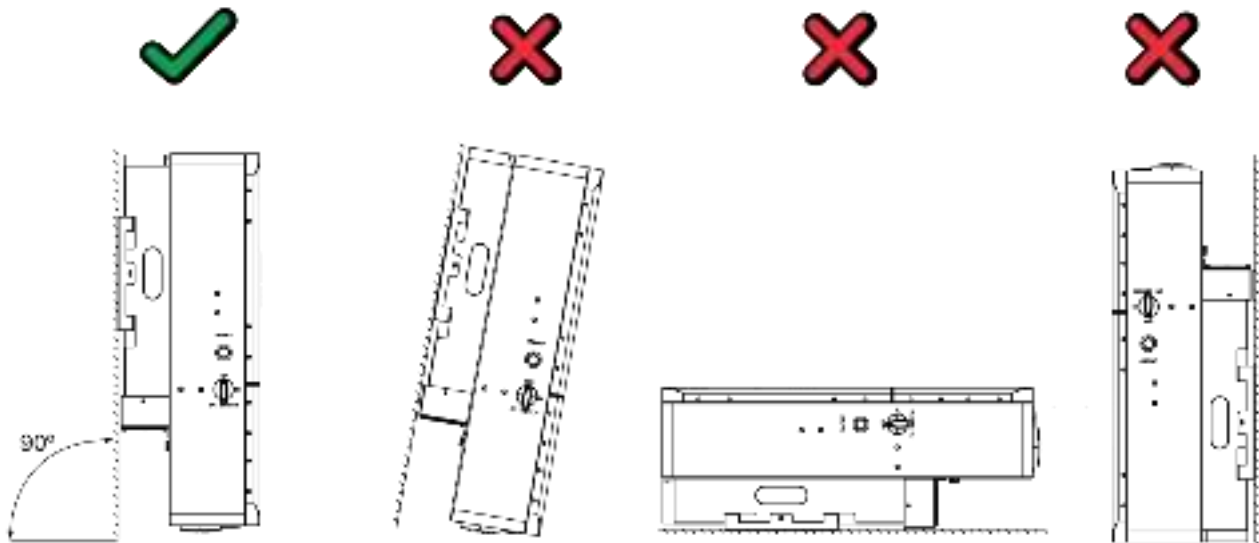

## 2.2 Integrating Batteries

**Note:** It's best practice to not mix battery banks of different makes, model, age, or chemistry. Doing so can adversely affect performance, and in some cases it could be hazardous.

1. ⚠️ Limitless 18K-2P-LV must be OFF while you connect the batteries.
2. Depending on the battery voltage, wire up the battery bank in the possible configurations shown below.
3. Battery breakers must be OFF when wiring. If your battery bank does not have internal breakers, maintain the necessary safety measures when handling.
4. ⚠️ The 18K-2P-LV reaches a max battery charge/discharge current of 350A<sub>dc</sub> if using both sets of battery terminals. If only one set of terminals is used, the max battery charge/discharge will be limited to 190A. See "Multi-Terminal Installation" on the next page for more information.
5. During battery-only operation (without PV), the available power output will vary proportionally with the battery's state of charge and corresponding voltage level.
6. The 18K-2P-LV features 2×250A internal battery breakers. An external OCPD may be required for the battery, depending on the local AHJ.

⚠️ Limitless 18K-2P-LV is a **48V<sub>dc</sub> nominal system**. **DO NOT** connect the inverter to any other battery configuration. If you use 12V batteries, you **MUST NOT** exceed 4 batteries in series. The inverter can work with any battery chemistry as long as it remains within the range of **40V<sub>dc</sub> to 60V<sub>dc</sub>**.

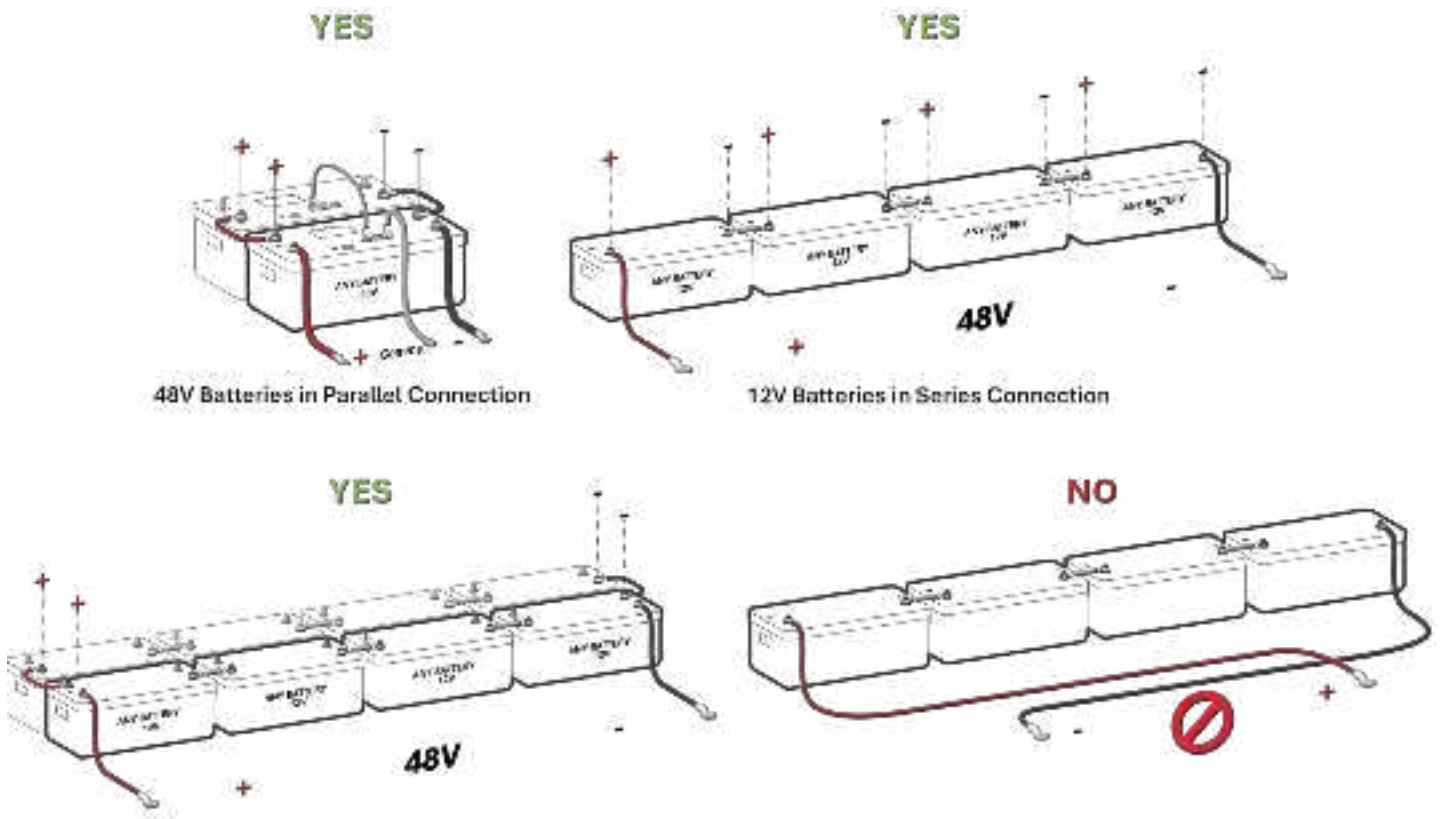

Series and parallel connections for complete 48V battery bank

⚠️ **DO NOT** reverse polarity. The system will be damaged, and warranty voided!

## Multi-Terminal Installation

You must use both positive and negative terminals as shown in the illustration. If you're using two sets of conductors to connect the batteries to the inverter, it is recommended to use a busbar or another suitable combiner for balanced battery charge and discharge. This configuration also ensures that you can charge and discharge at the maximum rate.

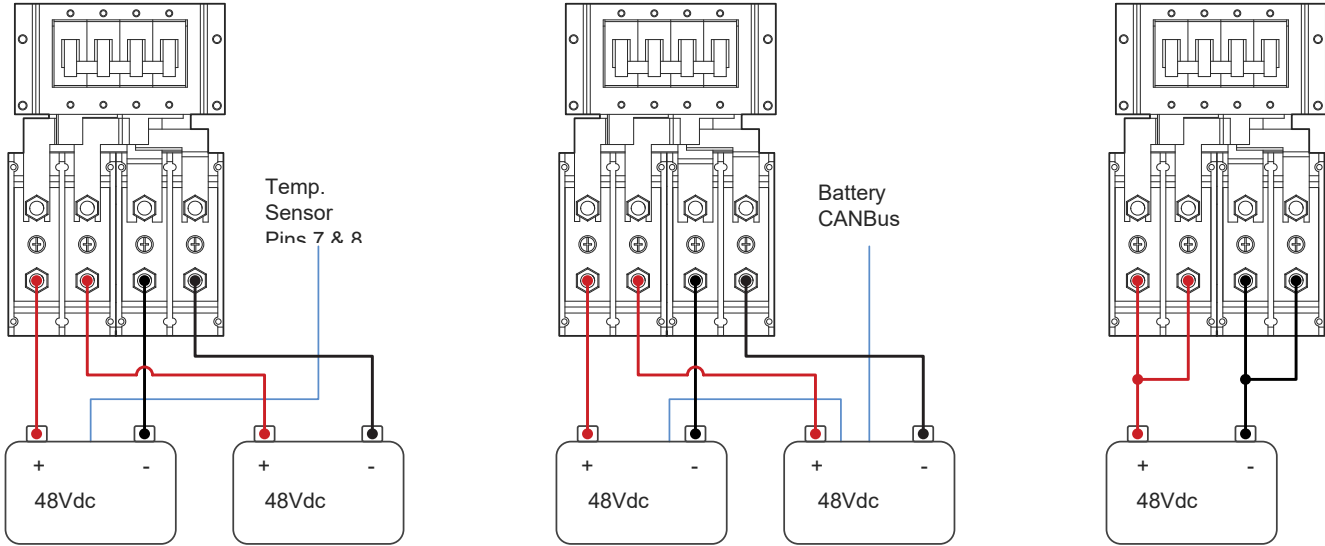

If a single battery is capable of charging / discharging above 190A, connect the battery to both input terminals. Otherwise, the charge and discharge rate will be limited to 190A max. Connect batteries of the same brand, model, and chemistry to both terminals.

**For units with 200A breakers**, the maximum allowable current is limited to 175A when only a single input terminal is used.

## Important Note: Multi-system installation

**ALL** parallel inverters **MUST** connect to a single battery bank. Otherwise, the system will **NOT** operate properly. **DO NOT** use separate battery banks in parallel systems.

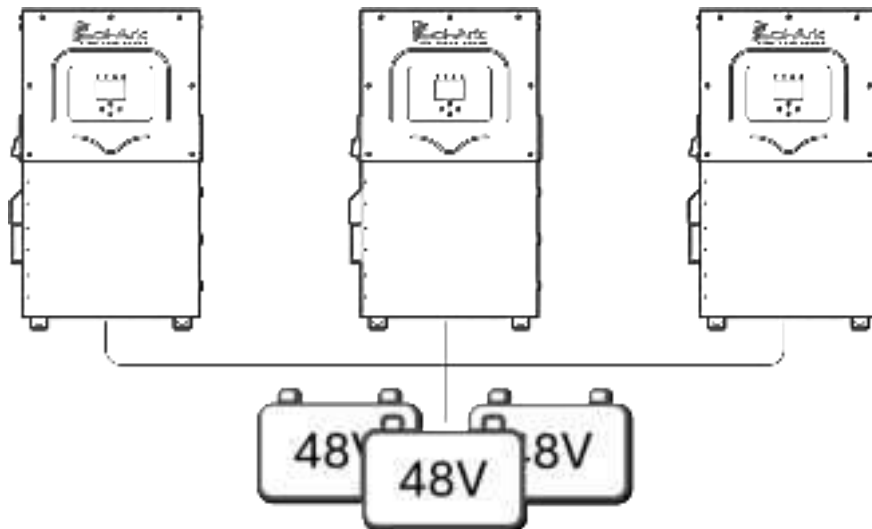

Follow all battery manufacturer-specified values to ensure proper charging and discharging.

## 2.3 Battery Communication

### RJ-45 Configurations

The Limitless 18K-2P-LV inverter achieves battery communications through a single RJ-45 port labeled “Battery CANBus”.

This port combines the RS-485 and CANBus pin configurations shown below.

Both “Modbus RS485” and “Battery CANBus” ports are capable of Modbus communication.

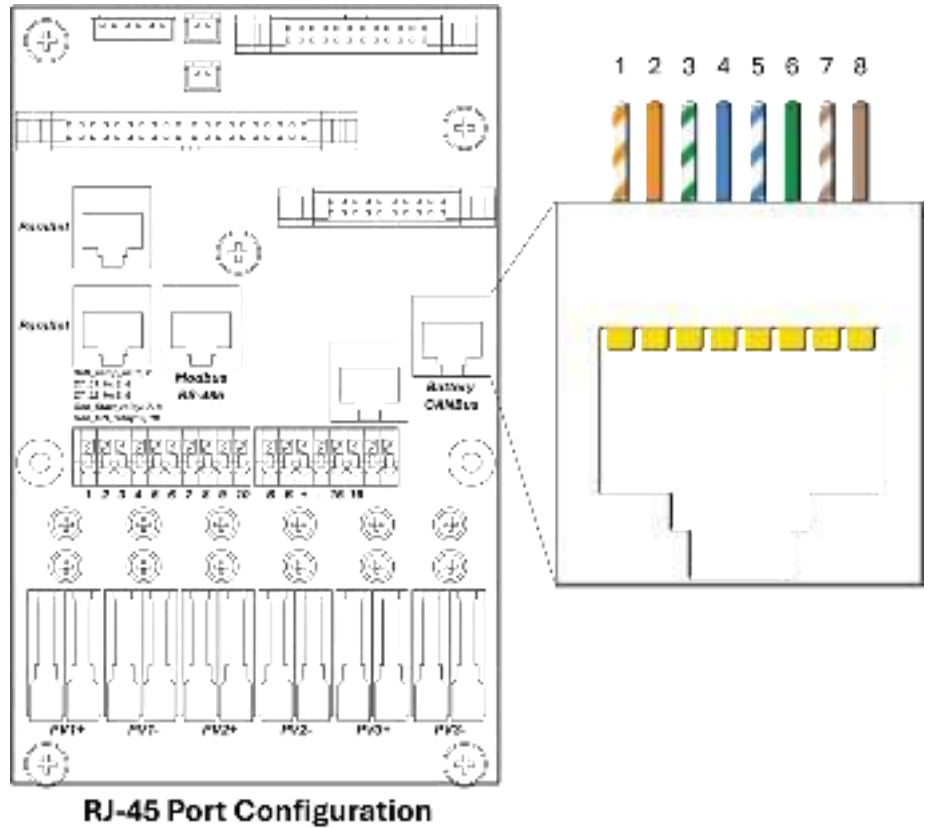

| Pin | RS485     | Battery CAN Bus |
|-----|-----------|-----------------|
| 1   | RS-485 B- | --              |
| 2   | RS-485 A+ | --              |
| 3   | --        | --              |
| 4   | --        | CAN Hi          |
| 5   | --        | CAN Lo          |
| 6   | GND       | GND             |
| 7   | RS485 A+  | --              |
| 8   | RS485 B-  | --              |

**!** For a complete list of supported battery communications, see: [sol-ark.com/battery-partners](https://sol-ark.com/battery-partners)

**!** Any damage caused by the improper use of the communication protocols (CANBUS or MODBUS) will not be covered by warranty. Modbus map is available upon request for “READ” operations only. Contact technical support to obtain the MODBUS map.





### External MODBUS Devices

If an external device utilizes **BMS Lithium Batt 00**, you must change the **Modbus SN** of the inverter to **01**, because the default value is **00**.

## 2.4 Connecting PV Modules



The Limitless 18K-2P-LV has 3 independent MPPTs that support up to 2 PV strings each. MPPTs can handle a maximum  $V_{oc}$  of 500V and an  $I_{sc}$  of 54A but will self-limit and operate at 36A max.

- A. Max. Usable PV Power = 28.8 kW ( $\pm 5\%$ ) | Max input power per MPPT = 9.6 kW | Max recommended input voltage per MPPT = 425  $V_{mp}$  | Max input current per MPPT = 36A (self-limiting).
- B.  Design for a max input current of 36A per MPPT. The inverter will self-limit beyond 36A. If  $I_{sc}$  exceeds 54A, damage will occur.
- C.  **PV Source Circuit max voltage of 500V<sub>DC</sub>; damage can occur with PV strings whose open-circuit voltage exceeds 500V<sub>DC</sub>**
- D.  Strings in parallel on the same MPPT must have the same designed open-circuit voltage ( $V_{oc}$ ); otherwise, the system will be limited to the lowest string voltage.
  - PV1 A/B must have the same  $V_{oc}$ .
  - If the solar panels are oriented in different directions and connected in the same MPPT, there will be a loss of PV efficiency.
- E.  According to NEC Art. 690.43, exposed non-current-carrying metal parts of PV module frames, electrical equipment, and conductor enclosures of PV systems must be connected to an equipment grounding conductor. All grounding conductors and grounding electrodes should be installed according to NEC Art. 690.47 or as required by the AHJ.
- F. For ground-mounted arrays, Sol-Ark recommends installing an auxiliary grounding electrode placed near the array to ensure optimal earth-to-ground resistance of the grounding system. This auxiliary electrode must follow the requirements of NEC Art 250.54.

Connect the solar panel strings using either of the following configurations:

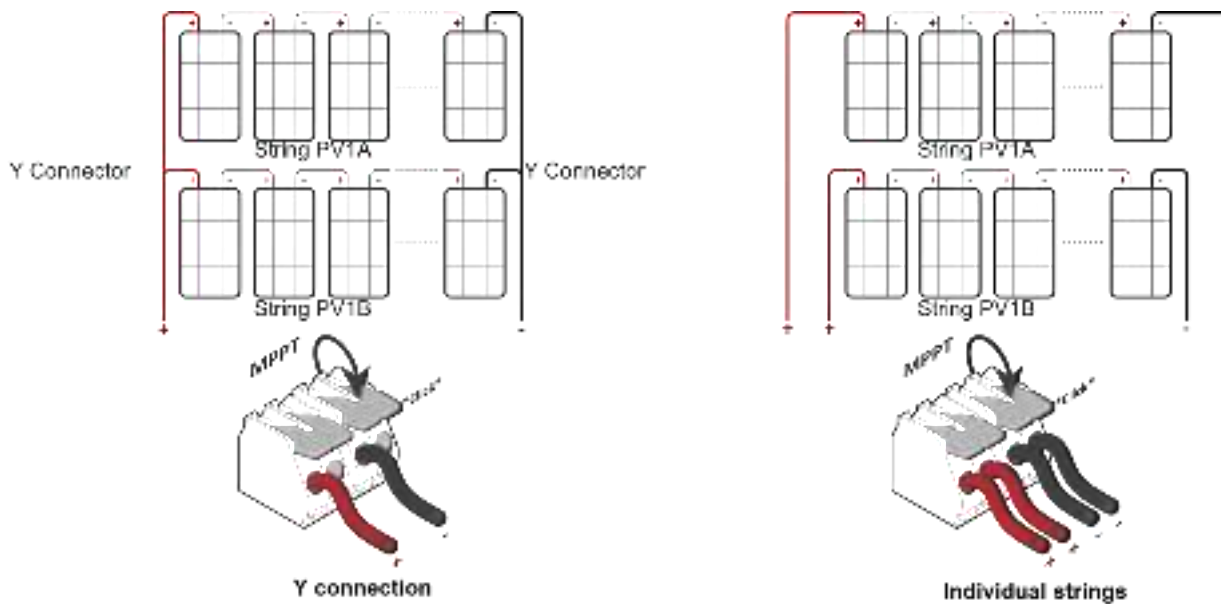



## AC Coupling

The Limitless 18K-2P-LV is a system that supports the addition of AC coupled solar panels. The max solar input power can be expanded by coupling micro or string inverters into the **GEN** or **LOAD** terminals. A full AC coupled solar system is not recommended as power control and monitoring is limited. Having DC coupled modules or a combination of DC coupled and AC coupled solar panels is always preferred.

AC coupled inverters need to be either UL 1741SA or UL 1741 certified. This certification confirms the inverters' ability to disconnect from the grid based on frequency and ensures that the Sol-Ark will safely be able to frequency shift to control the AC coupled production.

**!** Batteries are **REQUIRED** to AC couple solar panels to the **GEN** and **LOAD** terminal. The AC coupled inverters can still produce solar power even during grid outage events or in Off-Grid systems. Furthermore, the total AC coupling production will be monitored. See the [AC Coupling Guide](#) for more information.

### Option 1: AC coupling on **GEN**

- Maximum allowed AC coupling input: 28,800W
- **CAN** produce solar power during grid outages.
- **CAN** produce solar power for Off-Grid systems.
- **CAN** monitor solar production.

### Option 2: AC coupling on **LOAD**

- **CAN** produce solar power during grid outages.
- **CAN** produce solar power for Off-Grid systems.
- **CANNOT** monitor solar production.
- **⚠️ GEN** input **CANNOT** be used.
- **!** Backup Transfer Time is extended to 2 seconds.



**!** In Off-Grid systems, Sol-Ark uses Frequency Shift technology to shut down AC coupled solutions when the battery is full. Grid-Tied AC coupled solutions will always sell excess solar power back to the grid. "Limited to Load" will **NOT** limit production when AC coupled.





## 2.5 Integrating a Generator

When needed, the Sol-Ark inverter can make use of a 240 Volt generator to charge the battery connected to the Sol-Ark via the GEN port.

### Generators Smaller than 28.8kW → On GEN Terminals

1. **ONLY** Supports 120/240V Split-Phase generators.
2. 150A rated **GEN** terminal.  120A continuous.
3. Less than 15% Total Harmonic Distortion (THD) recommended to avoid frequent disconnects
4. NOT compatible with:
  - 120V Single Phase Generators
  - 120/208V 3-Phase Generators (2 of 3 Phases) -  Voids Sol-Ark Warranty



### Generators Greater than 28.8kW → On GRID Terminals

1. Supports 220V Single phase, 120/240V Split phase, 120/208V 3-Phase (2 of 3 phases). The correct grid type must be selected before connecting the generator.
2.  Programming **GEN Connect to Grid Input** is required:  > **Limiter** > **Other** >  **GEN Connect to Grid Input**.
3.  **DO NOT** use **Grid Sell** in Off-Grid systems. Potential to damage the generator. Installation of CT sensors on generator lines is only required if "**Peak Shaving**" is intended to be used.

 **Weekly Gen Exercise:** If a generator has two-wire start compatibility, it will experience weekly generator tests. This test occurs at 8:00AM (local time) every Monday by default. The test takes 20 minutes to complete. The generator will start and stop automatically. The test can be disabled by specifying: **00 | 00 min** in the option **Generator Exercise Cycle Day & Time**.



### Improve the Generator & Sol-Ark Compatibility

Navigate through the menus and program the following settings to improve the Sol-Ark and generator compatibility and operating range to avoid frequent disconnections.

1. Change the grid mode to General Standard:  > **Grid Setup** > **Grid Selection** > **Grid Mode**.
  - a. Tap and use the navigation arrows to cycle through the different grid modes. Choose **General Standard**.
2. Increase the frequency range of operation:  > **Grid Setup** > **Connect** > **Reconnect**
  - a. Increase **Grid Hz High to 65Hz**.
  - b. Decrease **Grid Hz Low to 55Hz**.
  - c. Replicate changes for the **Normal Connect** settings.
3. Increase the voltage range of operation:
  - a. Increase **Grid Volt High to 275V**.
  - b. Decrease **Grid Volt Low to 185V**.
  - c. Replicate these changes for the **Normal Connect** settings.

 Sol-Ark will not charge the batteries using the generator unless the **Start V** or **Start %** condition is met. Only one condition (**V** or **%**) can be modified at a time, depending on the control mode selected (**Use Batt V Charged** or **Use Batt % Charged**).

## 2.6 Grid Peak Shaving



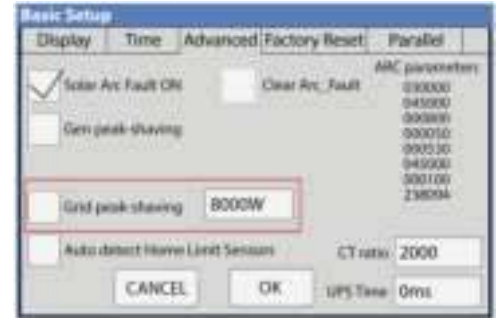

1.  To use Peak-Shaving on a generator, the equipment **MUST** be connected to the **GRID** terminal of the inverter.
2. Peak-Shaving helps reduce grid consumption during peak demand by utilizing battery backup power. It can also be used to prevent generator overload above a specified power threshold.
  - Improper Peak-Shaving parameters can lead to depleting the battery bank. For more information on this feature, visit the Sol-Ark [Knowledge Hub](#).
3. Install the CT sensors on grid / generator lines L1, L2. The arrows on the CTs **MUST** point toward the grid / generator.
4. The Sol-Ark supplies power from the batteries whenever the **Power** threshold is met.
5.  Grid Peak-Shaving will automatically enable **Time of Use** and **MUST** be configured.

To configure time-of-day-based Peak Shaving, see "Time of Use" on page 44.



Grid peak-shaving setting

## 2.7 Automatic Generator Start

1.  **Gen Charge** is used when the generator is connected to the **GEN** terminal.
  - a. **Start V or Start %** is the set-point/condition that must be fulfilled to **automatically start** the generator.
  - b. To charge from the **GEN** source, check the  **Gen Charge** box.
  - c.  Batteries will charge from a generator until the battery bank accepts 5% of its programmed capacity in Amperes (A). This is equivalent to around 95% of the state of charge (SOC).
2.  **Grid Charge** is used to charge the battery from the **GRID** source (either the Grid or a generator).
  - a. **Start V or Start %** is the set-point/condition that must be fulfilled to start the battery charge from the **GRID** source. This will auto-start a generator as well.
  - b. To charge the battery from the **GRID** source,  **Grid Charge** must be selected:  > **Battery Setup > Charge**.
  - c.  From utility grid: the batteries will be charged to 100% SOC.
  - d.  From generator: the batteries will charge until the battery bank accepts 5% of its rated capacity in Amperes (A). This is equivalent to around 95% SOC.

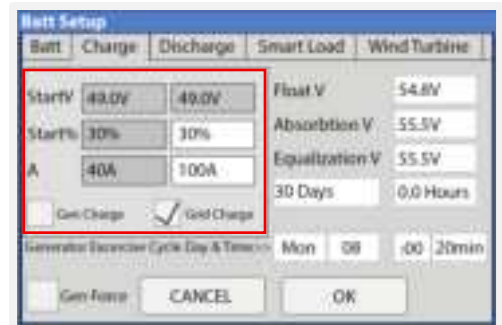

Generator and grid charge settings

 If **Time of Use** (TOU) is enabled, a time to charge from that **GRID** or **GEN** source **MUST** be designated. Be sure to check the  **Charge** box for the time intervals needed; otherwise, the generator will not start automatically even if **Start V** or **Start %** condition is met.

To use the automatic generator start feature, the generator must have a 2-wire start component, and it must be connected to ports 7 and 8 (see "2.8 Integrating Sensors and Accessories" on page 18). Consult the generator manufacturer to find out if your generator has a compatible **2-wire start** feature.

### Gen Charge / Grid Charge "A"

"A" is how many amps (**DC**) are supplied to the battery from a generator. Adjusting and limiting the **GEN** or **GRID A** value will ensure that small generators are not overloaded when charging the battery bank. If you're connecting more than one Sol-Ark in parallel, multiply the **Gen** or **Grid A** value by the **# of Sol-Ark inverters** to get the actual current (A) that will go into the battery bank.

## 2.8 Integrating Sensors and Accessories

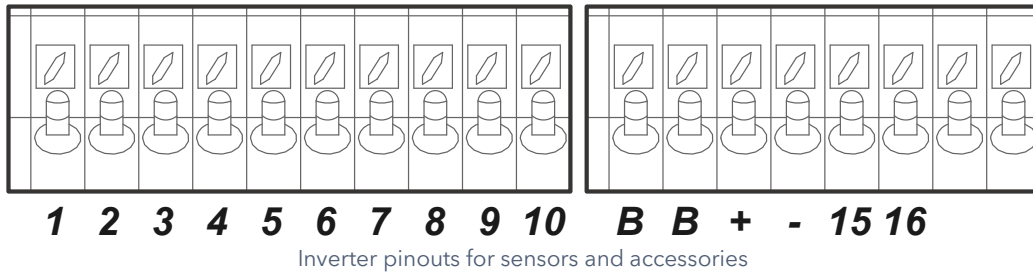

Gen Charge and Grid Charge settings

Sensors and accessories connect to these inverter pinouts:

|                      |                                   |  |
|----------------------|-----------------------------------|--|
| <b>1 &amp; 2:</b>    | <b>Battery temperature sensor</b> | Not polarity sensitive. Used for voltage compensation.                               |
| <b>+3 &amp; -4:</b>  | <b>CT1</b>                        | Current transformer (CT) inputs  |
| <b>+5 &amp; -6:</b>  | <b>CT2</b>                        | Current transformer (CT) inputs  |
| <b>7 &amp; 8:</b>    | <b>Gen Start Relay</b>            | Normally, open relay for generator two-wire start (⚠️ 12V, 100mA max)                |
| <b>9 &amp; 10</b>    |                                   | Not in use   |
| <b>B &amp; B:</b>    | <b>Emergency Stop</b>             | Normally open dry contact for emergency stop   |
| <b>+, -</b>          |                                   | Not in use   |
| <b>+15 &amp; -16</b> |                                   | 12Vdc power supply for RSD transmitters ( <b>100mA max, 12V<sub>DC</sub>, 1.2W</b> ) |

### Temperature Sensor

- Place the sensor between two batteries as shown below.
- Secure with tape and place away from the battery terminals to prevent overheating.
- This sensor has no polarity. The temperature sensor helps perform voltage charging adjustments and capacity calculations due to changes in temperature.

⚠️ Lithium Batteries **DO NOT** require our external temperature sensor.

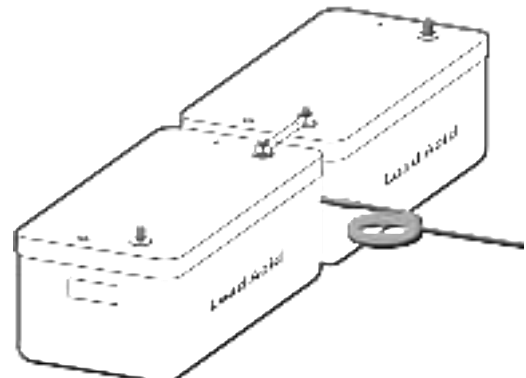

## Wi-Fi / Ethernet Antenna (Dongle)

- Remote monitoring and software updates require an internet connection through the Wi-Fi / Ethernet Antenna (Dongle).
- Compatible with Wi-Fi or Ethernet connections.

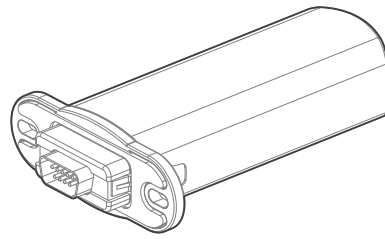

Wi-Fi dongle (antenna)

## BMS Port (CAN/RS485)

- This port is used to set up a Lithium Battery in closed-loop communication with the Limitless 18K-2P-LV. See the *Battery Communications Integration Guide* at [www.sol-ark.com/battery-partners](http://www.sol-ark.com/battery-partners).
- You must use an RJ45 connector.
- Only use the CAN port for battery BMS communications (the CAN port supports both CANBus protocol and Modbus protocols).

## GEN Start Signal (Two-wire start)

- Gen start relay: pins 7 & 8.
- The signal comes from a normally open relay that closes when the generator "Start" condition is met.

## Installing Filter Rings

If your inverter came with a set of filter rings, follow the steps on the next page to install them on the battery conductors. Make sure that both (+) and (-) wires pass through both toroids simultaneously. When there are 4 wires, all conductors must go through the toroids as shown.

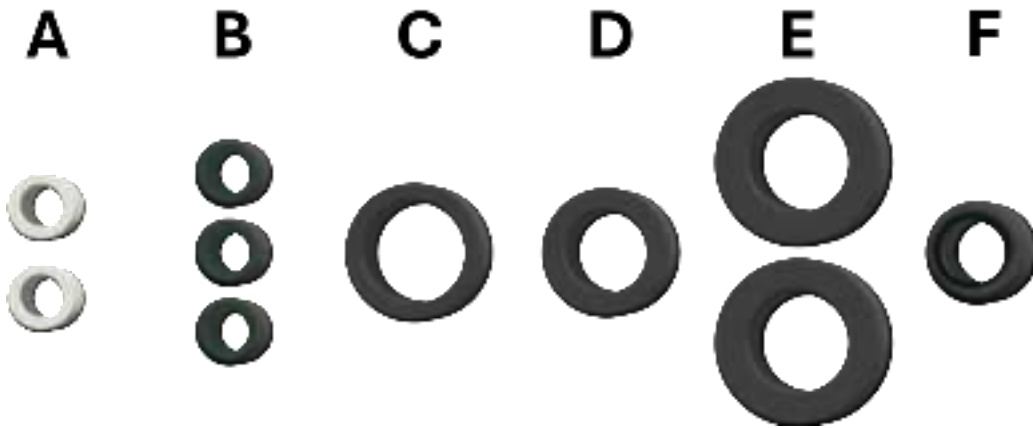

- A** 2 small white filter rings for BMS and Meter (outside diameter 33mm)
- B** 3 small black filter rings for wiring area (outside diameter 30mm)
- C** 1 medium black filter ring for load or generator (outside diameter 65mm)
- D** 1 medium black filter ring for grid port (outside diameter 59mm)
- E** 2 large black filter rings for battery (outside diameter 84mm)
- F** 1 small black filter ring for PV terminal (outside diameter 52mm)

**Filter Rings A** (2 small white filter rings)

1. Pass the BMS 485/CAN communication line through filter ring A and wrap it around four times.

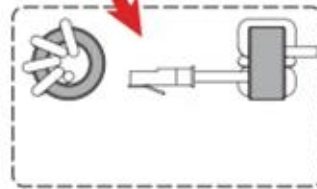
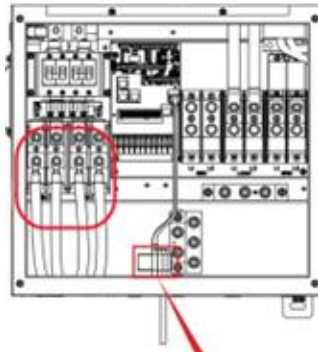

2. Pass the Meter-485 communication wires through the other filter ring A and wrap them around four times.

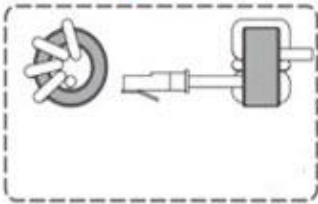
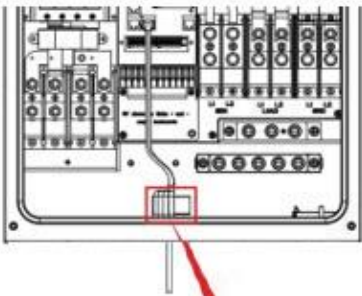

### Filter Rings B (3 small black filter rings)

For each of the three filter rings B: wrap the wires around twice, then thread the end of the wires through the filter ring. Do this for each of these components:

1. Batt \_ Temp \_ in (1,2), CT\_L1\_in (3,4), CT\_L2\_in (5,6): Wrap these wires around one filter ring B.
2. Gen\_Start\_relay (7,8): Wrap these wires around one filter ring B.
3. RSD \_ input (B, B, +, -), RSD 12V\_out (15 +, 16-): Wrap these wires around one filter ring B.

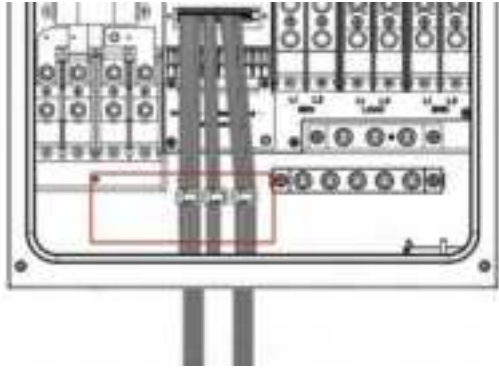

### Filter Ring C (1 medium black filter ring--outside diameter 65mm)

Filter ring C is the generator and load port ring. Follow the steps that apply to your setup.

- **If using the GEN and LOAD port:** pass all 6 GEN and LOAD conductors through filter ring C
- **If using only the GEN port:** pass GEN and LOAD conductors through filter ring C
- **If using only the LOAD port:** Pass all LOAD conductors through filter ring C

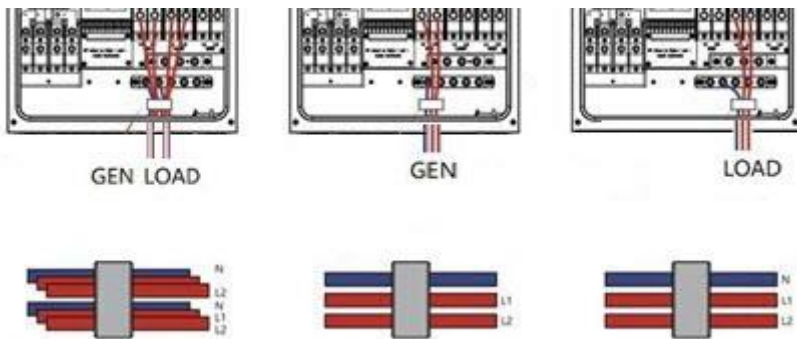

### Filter Ring D (1 medium black filter ring--outside diameter 59mm)

Pass GRID conductors (L1, L2, Neutral) through filter ring D, as shown below.

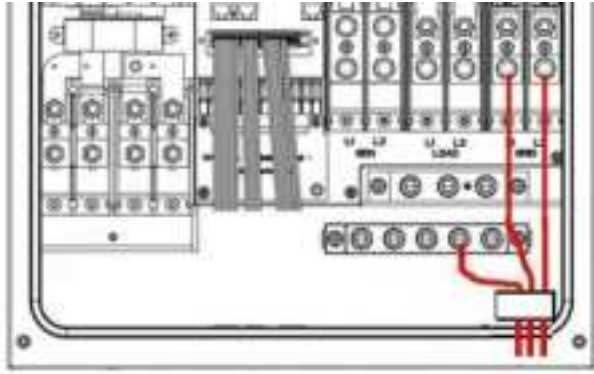

### Filter Rings E (2 large black filter rings)

Pass one positive and one negative battery power cable through filter ring E, then wrap them around the ring one time. Do the same for the other set of conductors.

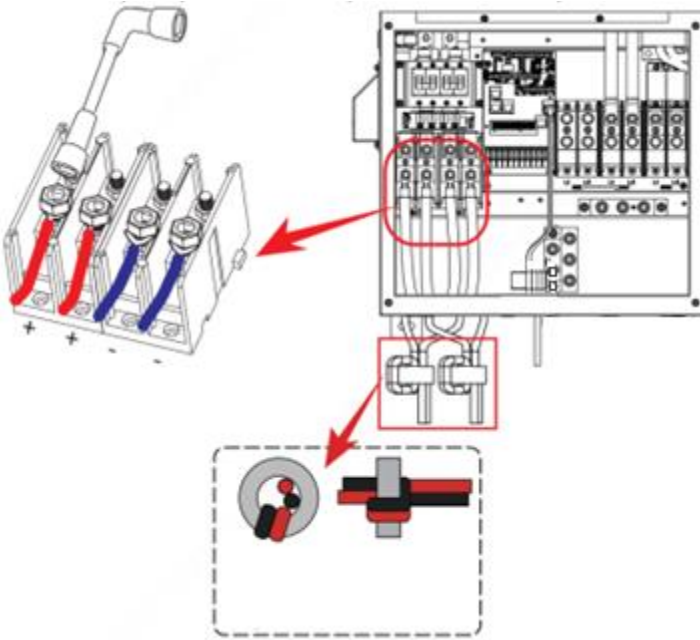

### Filter Ring F (1 medium-small filter ring)

Thread the wires of the PV terminal through Filter Ring F.

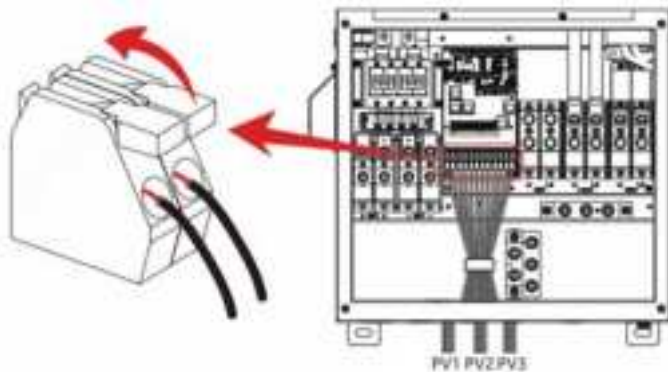

## 2.9 Limit Sensors (CT sensors)

The CT sensors (or limit sensors) enhance system capabilities by enabling the use of the system work modes known as **“Limited Power to Home”** (Meter Zero) and **“Grid Peak-Shaving.”** The CTs will measure and calculate total load demand which the Limitless 18K-2P-LV will then use to accurately supply and offset all existing loads (Meter Zero).

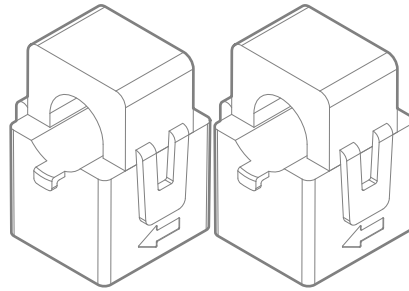

! Off-Grid systems do not require CT sensors unless “Grid Peak-Shaving” is used.

### Installing CT Sensors

- Install sensors on incoming electrical service wires (L1, L2, and L3 if the system is 3Φ).
- Embossed arrows on the sensors must point toward the grid.

! If the system is 3Φ, the arrows must point toward the inverter(s).

- To ensure proper fit, check incoming wire diameters (grid or generator). If the sensors are too small, you can contact Sol-Ark Sales to purchase bigger CTs at +1-972-575-8875 ext. 1, or [sales@sol-ark.com](mailto:sales@sol-ark.com)
- **“Limited Power to Home”** (Meter Zero) and **“Grid Peak Shaving”** require CT sensors.
- See “3.5 Limiter” on page 39 for more information about the different work modes.
- See Section 7, “Wiring Diagrams” on page 64 for more information on CT installation.

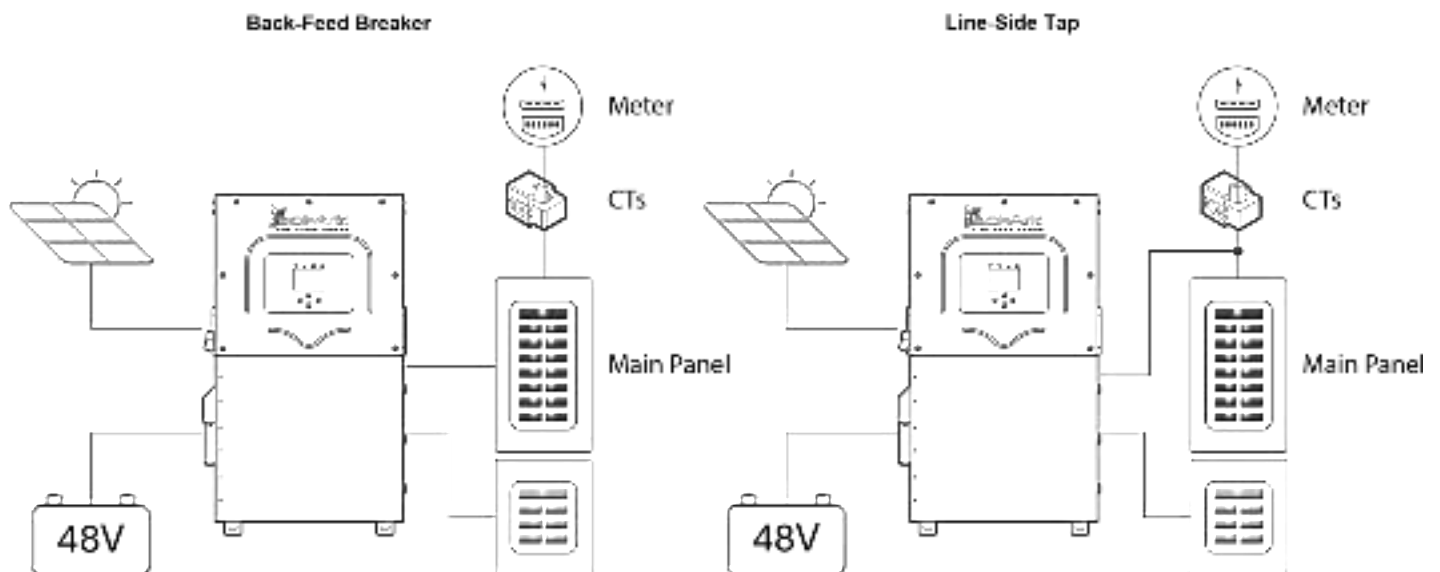

## CT Sensor Size

- The Limitless 18K-2P-LV includes two **300A** CT sensors (Ø1.378”).
- Sol-Ark offers large **200A** (Ø0.945”) and extra-large **600A** (Ø1.976”) CT sensors upon request. Contact Sol-Ark Sales at +1 (972) 575-8875 or [sales@sol-ark.com](mailto:sales@sol-ark.com) to purchase larger CT sensors.
- Default Sol-Ark CT ratio is 2000:1

**⚠** Unless authorized, **DO NOT** change CT Ratio or warranty will be voided.

## Wiring the CT sensor

- Connect CT1 of line L1 to pins 3 (white) & 4 (black).
- Connect CT2 of line L2 to pins 5 (white) & 6 (black).
- Keep the wires twisted (white-black) throughout the connection.
- If the wires need to be extended, use CAT 6 (shielded) cable to make an extension.

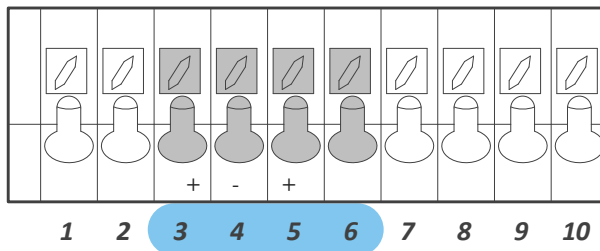

## CT Sensors for 120V/240V Split Phase

- Each inverter includes 2 CT sensors.
- Only one pair of CT sensors must be wired to the designated “Master” inverter.

**ⓘ** CT sensors are essential for multi-Sol-Ark systems as “Limited Power to Home” mode is highly recommended.

## CT Sensors for 120V/208V Three-Phase

- Install CT1 on L1 and CT2 on L2 of inverter 1. Program inverter 1 to Master, Phase A.
- Install CT3 on L3 of inverter 2. Program inverter to be Master Phase B. Use pins 5 and 6 for CT3.

**ⓘ** CT sensors on 3-Phase systems **MUST point in the opposite direction** (toward the inverters).

## Automatic CT Limit Sensors Configuration

This function **REQUIRES** batteries and 120/240V grid to auto detect and auto correct CT orientation. AC coupled inverters need to be **OFF** during the detection test.

If this test is done with connected AC-coupled systems, a factory reset of the Sol-Ark must be performed.

Install the CT sensor as described in “

2.9 Limit Sensors (CT sensors)” on page 23.

A battery connection and grid power are required before starting the automatic configuration.

**☰ > Basic Setup > Advanced >  Auto detect Home Limit Sensors**

Wait at least 10 to 15 seconds while the inverter performs the test. The inverter will alternate the current distribution in all lines, determining the correct orientation of the sensor.

- On “Limited power to Home” mode (no Grid Sell), HM values will read close to zero (0). Be aware that all sensors have a 3% error.
- To avoid selling power to the utility use “Zero Export Power” equal to or greater than 20W.
- Buying power from the grid will display positive (+) HM values, while selling to the grid displays negative (-) HM values.

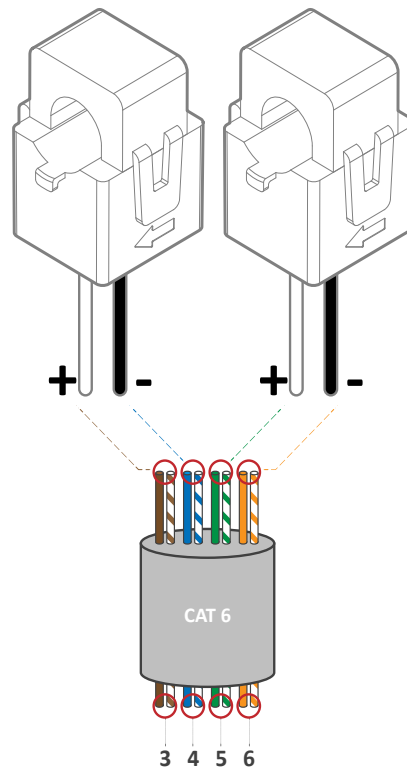

CT wire extensions with shielded CAT 6 cable

## 2.10 Emergency Stop and Rapid Shutdown

**Note on optimizers:** Some third-party module level optimizers may not be compatible with the Sol-Ark inverter. If you're using optimizers, consult a qualified installer for an alternative method for optimization, such as microinverters or another rapid shutdown solution.

### Powering the Rapid Shutdown Transmitter

There are two ways to set up your transmitter for rapid shutdown, depending on the rated power draw of the RSD transmitter. Check the manufacturer's documentation to determine how much amperage your transmitter draws.

#### Option 1: RSD draws up to 100mA

The (B, B) emergency stop pins of the Limitless 18K-2P-LV are an ordinarily open contact that triggers rapid shutdown (RSD) when closed. RSD will cut all power, including the Sol-Ark's internal power supply and stop all AC outputs. The internal 12Vdc (-3%) power supply of the Sol-Ark (pins 15 & 16) will disconnect any RSD transmitter that will then shut down all solar panels when the emergency stop button is pressed.

- Emergency stop button connects to (B, B) pins of the Sol-Ark.
- RSD transmitter connects to pins 15 & 16 (12Vdc power supply)

! Transmitters placed inside the user area of the Sol-Ark can cause interference.

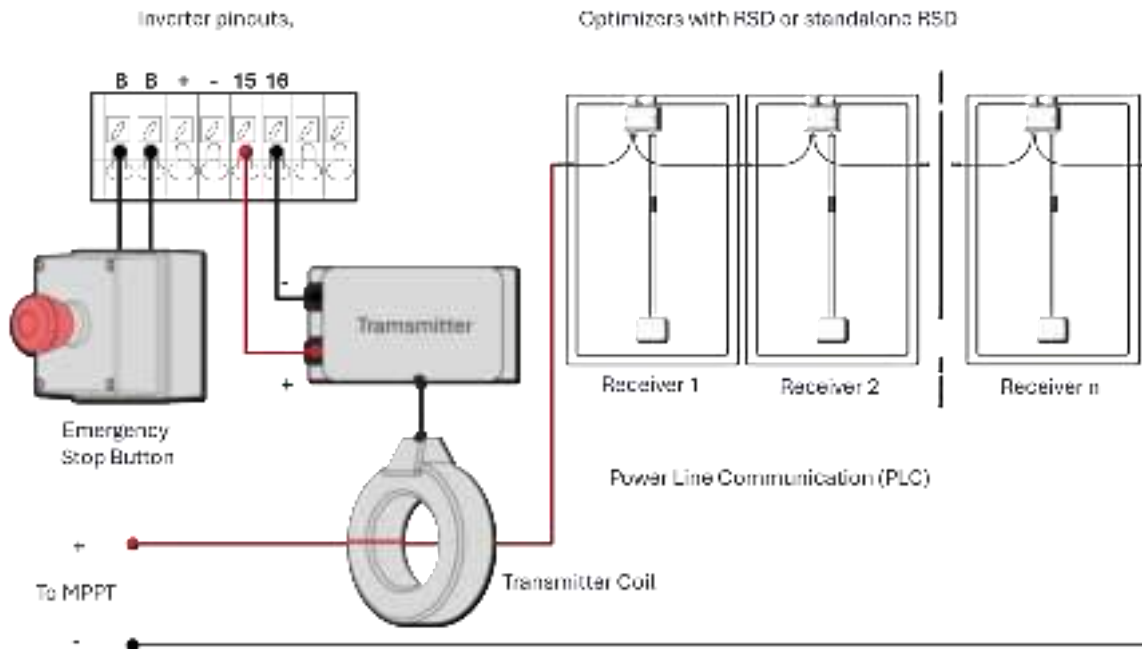

#### RSD Warning!

- ⚠ The Built-in 12Vdc power supply of the Limitless 18K-2P-LV (Pins 15 & 16) is rated for 100mA (1.2W). Do not exceed! If you are unsure of the current (A) rating of the transmitter, contact the manufacturer before connecting.

## Option 2: RSD transmitter draws greater than 100mA

If a transmitter is equal to or more than the maximum 100mA limit, it can still be integrated into the Sol-Ark inverter through an external power supply connected to the **LOAD** output.

Pressing the **e-stop** button will disconnect all AC outputs, cutting power to the **LOAD** service panel, which will initiate rapid shutdown.

The illustration shows an example.

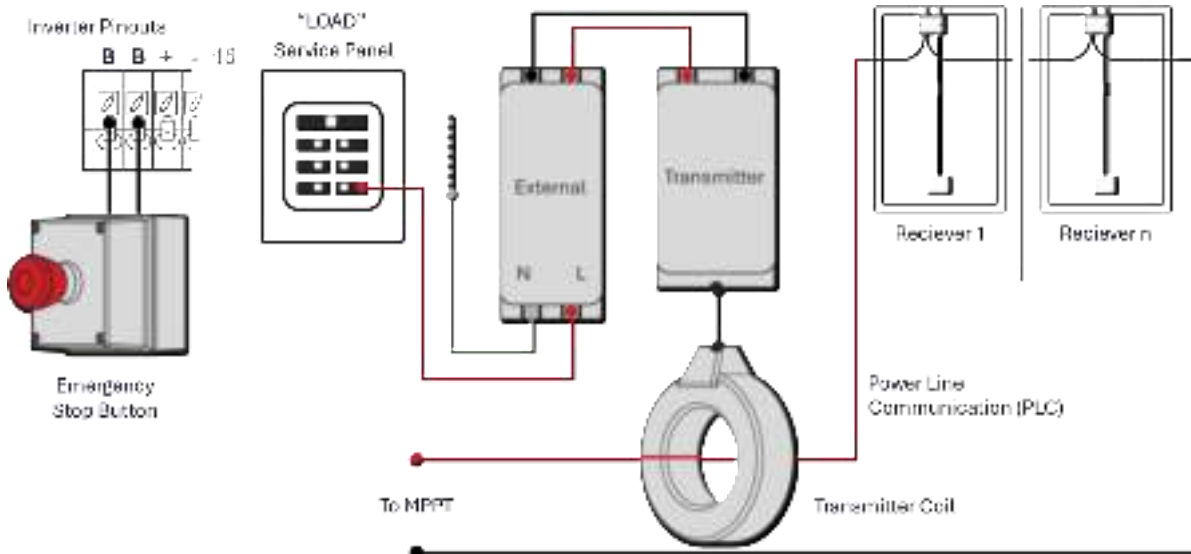

## Rapid Shutdown Product Recommendations

These recommended rapid shutdown solutions are readily available on the market:

- Tigo TS4-A-F
- Tigo TS4-A-2F
- NEP PVG-Guard
- APsmart RSD S-PLC
- APsmart RSD-D

## 2.11 Powering-Up the Sol-Ark

! TURN ON the inverter with at least one power source: Battery, PV, or Grid.

### 1. Check the voltage of the battery bank

- ⚠ Voltage of the battery must be between  $40V_{DC}$  -  $60V_{DC}$ .
- If applicable, turn **ON** internal switches of the batteries. Measure individual voltages.
- Verify that the voltage of the battery bank at the Sol-Ark terminals is adequate.

⚠ **DO NOT** reverse polarity. **DO NOT** turn **OFF** battery disconnect if any current is flowing into or out of the battery.

### 2. Check the voltage of each PV input circuit

- ⚠ Input voltage must not exceed  $500V_{DC}$ .
- Input voltage must be above the startup voltage of  $125V_{DC}$ .
- ⚠ Do not ground PV+ or PV-.
- ⚠ Verify polarity in each PV string. Backward polarity will measure  $0V_{dc}$  by the Sol-Ark and will cause long-term damage.
- ! PV alone turns LCD screen only. Inverter requires **grid** and/or **batteries** to operate, otherwise an "OFF" message will appear.
- PV DC disconnect switch on the side of the inverter will turn the PV ON or OFF.

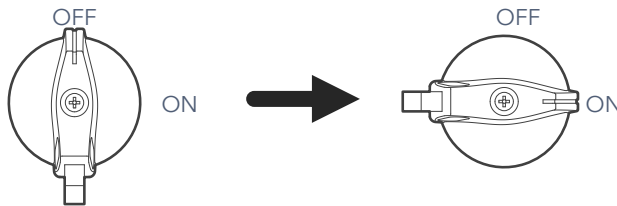

### 3. Check GRID input voltage

- Use the **GRID** terminals to measure AC voltage with a multimeter.
- Measure line (L) to neutral (N) voltages on **GRID** terminals. Ensure  $120V_{AC}$  on all phases.
- Measure line (L) to line (L) voltages on **GRID** terminals. Ensure  $240V_{AC}$ . (If voltage reading is close to  $220V$  or  $210V$ , verify if grid is single-phase or three-phase instead).
- Verify that voltage between Neutral and Ground is  $0V_{AC}$ .
- Verify that voltage between **GRID L1** and **LOAD L1** is  $0V$ . Do the same for L2.

## 4. Power ON the Limitless 18K-2P-LV | Single Inverter Systems

Follow the instructions below for your power source.

### 4.1 Powering up from a Battery bank

- A. Turn **ON** the battery breaker(s).
- B. **PRESS** the power button to the **ON** position.
- C. **PROGRAM** the settings on the inverter according to your **Battery** and **GRID** type. The unit is programmed in **Split Phase 120/240V** by default.
- D. Wait for the **Normal** LED indicator to turn on. This may take a few minutes.
- E. Turn **ON** the PV DC disconnect switch. Wait for the **DC** LED indicator to turn on.
- F. Turn **ON** the external **GRID** disconnect. Wait for the **AC** LED indicator to turn on.
- G. Turn **ON** the internal **LOAD** and external **GEN** breakers.

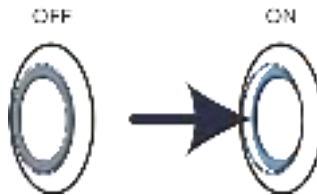

### 4.2 Powering up from the Grid

- A. Turn **ON** the external **GRID** disconnect and wait for "AC" LED indicator to turn on. Do **NOT** press the power button yet.
- B. **PROGRAM** the settings on the inverter according to your **GRID** type. The unit is programmed in **Split Phase 120/240V** by default.
- C. **PRESS** the power button to the **ON** position.
- D. Turn **ON** the PV DC disconnect switch. Wait for the "DC" LED indicator to turn on.
- E. Wait for the **Normal** LED indicator to turn on. This may take a few minutes.
- F. Turn **ON** the internal **LOAD** breaker.



- If your system does not have a PV source, you can skip steps D and E. Under these conditions, the inverter will operate in pass-through mode only.
- If no battery bank is connected to the inverter, the **GEN** port will be disabled as it requires the battery **SOC%** to open and close the internal **GEN** port relays.



## 5. Power ON Limitless 18K-2P-LV | Parallel install

### 5.1 Powering up from a Battery bank

1. Turn **ON** the battery breakers for all of the units, the order does not matter in this step.
2. **PRESS** the power button to the **ON** position in all units; the order of the units is not important.
3. **SELECT** as the "**Master**" unit one of the inverters to **PROGRAM** the **GRID** type and **Battery** settings. By default, the units are set to **Split Phase 120/240V**. The parallel communication will copy the settings from the "Master" unit to all "Slave" units. It's not necessary to program GRID and Battery settings in each unit.
4. **SET** the "**DIP switches**" as shown in "5.1 Before Enabling Parallel Operations." **PROGRAM** each inverter for parallel operation as shown in "5.2 Parallel Systems Programming Sequence" on page 50.
  - **VERIFY** the **GRID** and **Battery** parameters are properly transferred from the "Master" unit to the "Slave" units. Wait for the **Normal** LED indicator to light up on each unit. This may take a few minutes.
5. Turn **ON** the PV DC disconnect switch for all units. Wait for **DC** LED indicator to turn on for all units.
6. Turn **ON** the external **GRID** disconnect/breakers. Wait for **AC** LED indicator to turn on for all units.
7. Turn **ON** the internal **LOAD** and external **GEN** breakers.

### 5.2 Powering up from the Grid

1. Parallel communication CANNOT be established without a Battery Bank. In these systems, it's not necessary to activate parallel operation for the inverters.
2. The powering-up process is the same as the one described for single inverter systems in "4.2 Powering up from the Grid" on page 29.

## 2.12 Power Cycle Sequence

### Single Inverter Systems

1. **TURN OFF** all AC breakers and disconnects (**GRID**, **GEN**, and **LOAD**).
2. **TURN OFF** the built-in PV DC disconnect switch on the side of the inverter.
3. **PRESS** the power button, making sure it is in the **OFF** position. The LCD screen will turn off after a few seconds.
4. **TURN OFF** the battery breakers.
5. Wait a moment (~1 min) to make sure the inverter is completely de-energized.
6. Make sure that the Sol-Ark is properly connected to the batteries, solar panels, **GRID**, **GEN**, and **LOAD**.
7. Reverse the steps to turn **ON** the Sol-Ark.

### Parallel installation

1. **TURN OFF** all AC breakers/disconnects (**GRID**, **GEN**, and **LOAD**) for all units. Start with the "Master" units and then proceed to the "Slave" units.
2. **TURN OFF** the built-in PV DC disconnect switch on the side of the inverter. Start with the "Master" units and then proceed to the "Slave" units.
3. **PRESS** the power button, making sure it is in the **OFF** position. Start with the "Master" units and then turn off the "Slave" units.
4. **TURN OFF** the battery breakers. The order of the units in this step is not important.
5. Wait a moment (~1 min) to make sure the inverter is completely de-energized.
6. Make sure that the inverters are properly connected to the batteries, solar panels, **GRID**, **GEN**, and **LOAD**.
7. Reverse the steps to turn **ON** the inverters. When powering ON, always start with the "Slave" units and finish with the "Master" units.

## 3. User Interface

### 3.1 LED Indicators

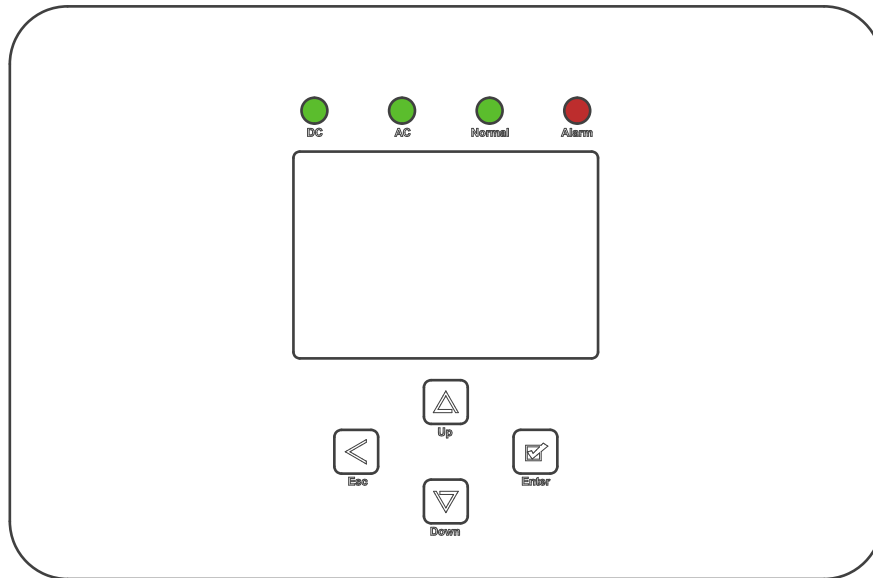

| DC   | AC   | Normal  | Alarm  |
|--|--|---|--|
| <b>Green</b> > DC Solar Panels connected and providing voltage.                    | <b>Green</b> > Grid is connected and providing voltage.    | <b>Green</b> > Sol-Ark is <b>fully energized*</b> and inverting power.    | <b>Red</b> > Alarm state. Check the alarms menu. Home Screen >  > "System Alarms" |
| <b>OFF</b> > Minimum MPPT voltage not met, wrong polarity or no PV <sub>DC</sub> . | <b>OFF</b> > Grid voltage out of range or Off-Grid system. | <b>OFF</b> > Not fully energized*, in fault state or in passthrough mode. | <b>OFF</b> > No alarms / error codes / setting change notifications  |

\*Fully energizing the unit constitutes at least:



- a. DC Solar panels AND Grid
- OR
- b. Batteries only

## 3.2 Main Menus



## Main Screen

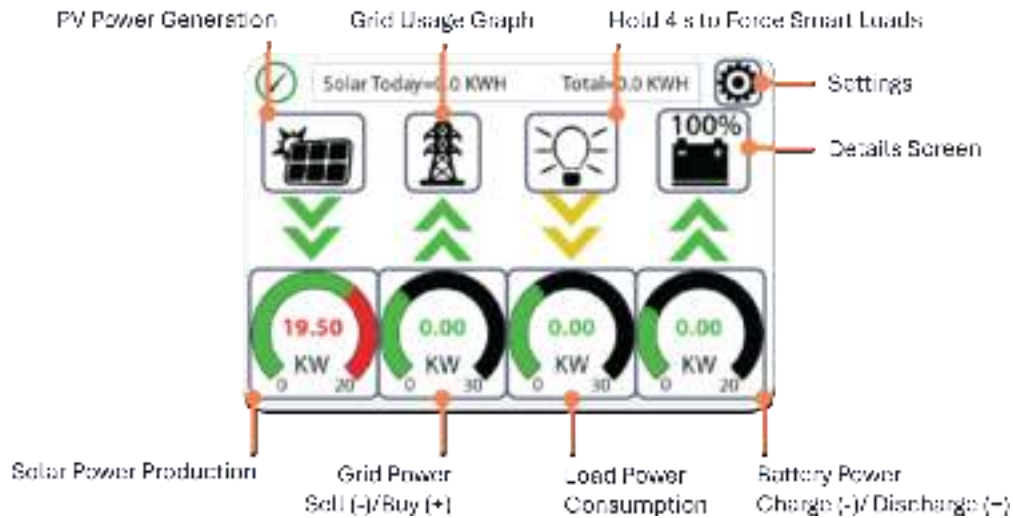

## Details Screen

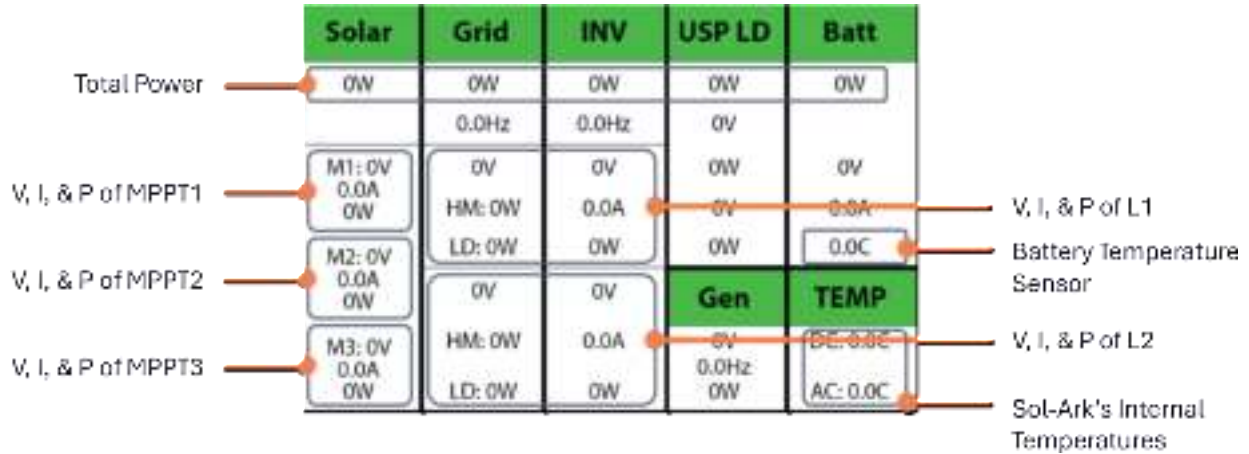

- ⚠️ MPPT voltages **MUST NOT** exceed 500V.
- Battery temperature will measure 25°C by default if the battery sensor is not connected.
- ! DC Temp: Limitless 18K-2P-LV does not have internal DC temperature sensors. You can ignore the temperature reading.
- AC Temp: Internal AC conversion side temperature. Output derating occurs at 75°C and above; shutdown occurs at 82°C.
- Grid** column measures: Voltage, Current, Power and frequency of the utility grid.
  - If selling to the Grid, Watts = negative (-)
  - If buying from the Grid, Watts = positive (+)
  - HM: power measured by the external CT sensors. (L1, L2).
  - LD: power measured by the internal sensor on **GRID** terminal. (L1, L2).

! Opposing **GRID** or **HM** values indicate an incorrect installation of the CT. See "Wiring Diagrams" starting on page 64.

## PV Power Generation Graph

- 1 Displays power production over time for the PV array.
- 2 Use up/down arrows (↑, ↓) to navigate between days.
- 3 Month view/ year view/ total production.

## Grid Usage Graph

- 1 Displays power drawn from grid (+) / sold to the grid (-).
- 2 Values above the line indicate "power bought" from the grid.
- 3 Values below the line indicate "power sold back" to the grid.
- 4 This view can help to determine when the peak power is used from the grid.

## System Setup Menu



## 3.3 Basic Setup

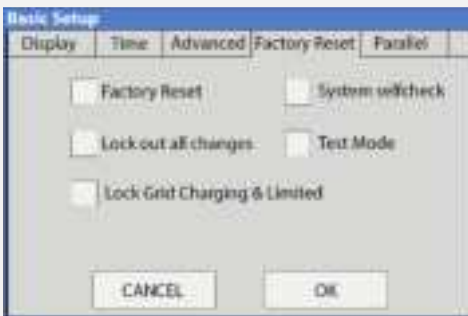
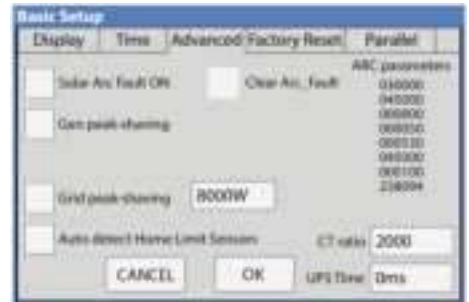
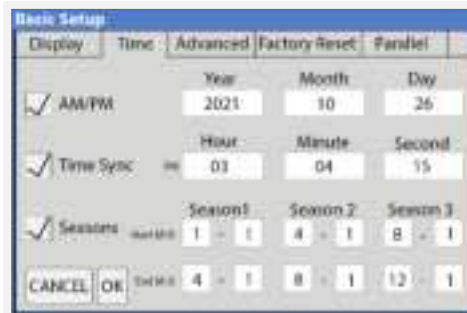
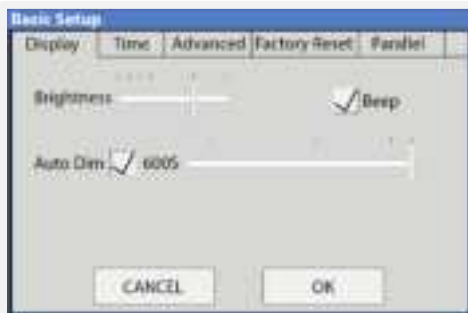

### Display

**Brightness:** Brightness adjustment (+, -).

**Auto Dim:** Must be enabled at all times to validate the warranty of the LCD screen.

**Beep:** Enable / disable the alarm sound.

### Time

**Time Sync:** Automatically syncs with the internet for daylight saving time changes. (Enabling "Time sync" is recommended.)

**Seasons:** Setup and customize the seasons for TOU.



## Advanced

**Solar Arc Fault ON:** Enables Arc fault detection algorithm on the MPPTs.

**Clear Arc Fault:** Command to clear an Arc Fault.  It must be done manually every time the system detects an F63 Arc\_Fault alarm. See section "8.1 Sol-Ark Error codes" on page 78 for more detail.

**Gen Limit Power:** Limits the power drawn from the **GEN** AC source. The inverter will reduce battery charge when value is reached.

**Load Limit Power:** Sets a limit to the total **LOAD** output power. The max output power of the inverter is programmed by default.

**Grid-Peak Shaving:** Sets a **GRID** consumption threshold that allows use of battery backup power during peak demand. External CT sensors are required. Peak shaving can be used on a generator provided it is wired to the **GRID** terminal.

**Auto detect home Limit Sensor:** Detects and auto-corrects the polarity of the CTs. See "2.9 Limit Sensors (CT sensors)" on page 23 for details.

**CT Ratio:** Specifies the transformation ratio of the CT. Default value of 2000:1

 **DO NOT** change or warranty will be voided.

**UPS Time:** Backup transfer time to essential loads upon grid disconnection. Default value of 5ms.

## Factory Reset

**Restrictions:** Changes to these settings must be previously authorized by Sol-Ark technical support agents.

## Parallel

**Parallel:** Enables communications between parallel inverters. "Master" and "Slave" inverters must be programmed.

**MODBUS SN:** Identification number for each system configured in parallel (1,2,3,4, n).

**Phase:** When dealing with a 120/208V 3-Phase system, there must be a "Master" unit responsible of their own phase (A, B, C).

 See section 5, "Parallel Systems" on page 50 for more information.

## 3.4 Battery Setup

**Note:** Default values on your model may be different than those pictured.

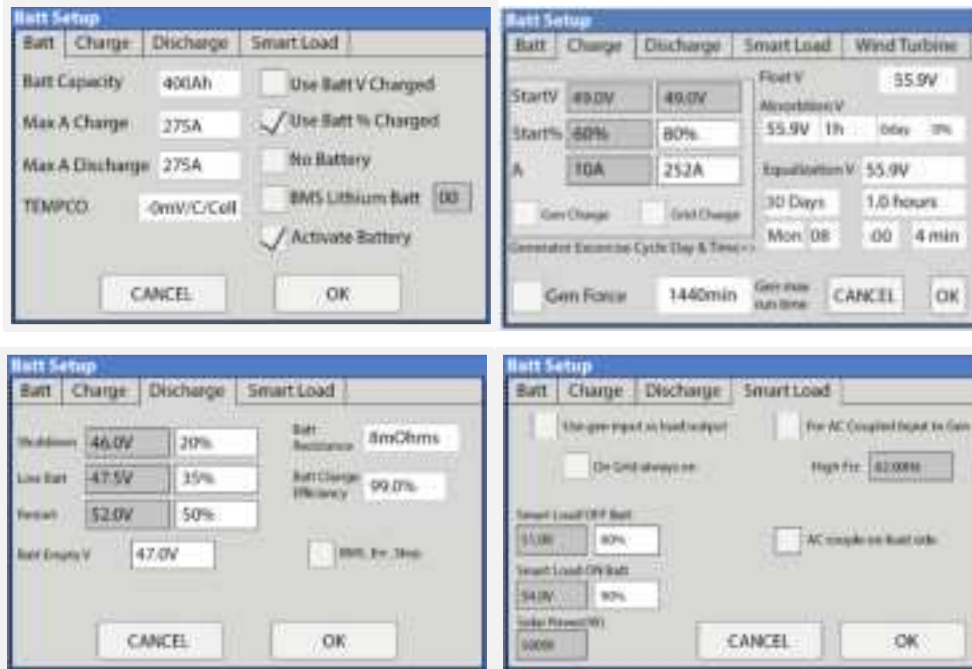

### Batt

**Batt Capacity:** Specifies the capacity of the battery bank. Value expressed in Amp Hour (Ah).

! **Batteries in series:** Voltage adds up (V).

! **Batteries in parallel:** Capacity adds up (Ah).

**Max A Charge:** Sets the maximum charge current (A) rate to the batteries when charged from solar power > 350A max allowed.

■ **For Lead-Acid batteries:** If the manufacturer does not specify rated charge amps, use 20% - 30% of battery capacity as Max A Charge.

**Max A Discharge:** Sets the maximum discharge current (A) rate from the batteries to > 350A maximum allowed.

For Off-Grid systems, the battery bank will discharge 120% of this value for a 10 second surge before the inverter faults to prevent battery damage.

**TEMPCO:** Temperature coefficient used in conjunction with the battery temperature sensor to adjust optimal voltages for lead-acid batteries.

! Lithium batteries do not require a TEMPCO setting (-0 mV/C/Cell).

**Use Batt V Charged:** Displays battery charge in terms of voltage.

**Use Batt % Charged:** Displays battery charge in terms of %. The inverter uses algorithms measuring power in and out to estimate a true value for state-of-charge %. It compensates for aging batteries.

**No Battery:** The **No Battery** option **MUST** be selected if there is no battery. A power cycle sequence is **REQUIRED** when selecting this option. See "2.12 Power Cycle Sequence" on page 30 for power cycle instructions.

**BMS Lithium Batt:** Allows closed-loop communication with the tested batteries included in Sol-Ark's *Battery Integration Guide*. See [www.sol-ark.com/battery-partners](http://www.sol-ark.com/battery-partners) for complete list of compatible batteries.

**Activate Battery:** This option **MUST** be selected if the system has batteries, especially Lithium batteries. When enabled, if battery voltage falls below the inverter's normal operating voltage range, selecting **Activate Battery** allows the inverter to wake the battery if PV or Grid are available to trickle charge the battery back to its operational voltage range.

## Charge

**Float V:** Lower steady voltage at which the battery is maintained after being fully charged.

**Absorption V:** Constant voltage used to charge the battery.

- Absorption will stop at 98% of the capacity of the battery bank and then drop to the Float setpoint.
- Example: A 400Ah battery will stop charge reaching 392Ah.

**Equalization V:** Voltage that the system uses to generate a calculated overcharge, utilizing a higher voltage or equal to the absorption to remove the generation of sulfates in lead-acid batteries. Used to balance internal cells.

! Most Lithium batteries do not need to equalize.

**Days:** The period between equalization cycles.

**Hours:** The period taken to equalize batteries.

! If "Hours" is set to 0 hours, the system will not equalize batteries.

**Gen Charge:** Uses the **GEN** input of the system to charge the battery bank from a generator.

- **Start V:** Voltage at which the system will AutoStart a generator to charge the battery.
- **Start %:** Percentage S.O.C (state of charge) at which the system will AutoStart a generator to charge the battery.
- **A:** Maximum rate of charge of the batteries from the generator (DC amps).

**Grid Charge:** There are two scenarios in which this option is used:

- **Grid connected to Grid input:** The inverter will limit the charge rate to the set value in "A" and the battery will charge to 100% SOC.
- **Generator connected to Grid input:** It will be necessary to select  **GEN connect to Grid input**. The system will use **Start V**, **Start%** and **A** conditions to charge the battery and stop charging at 95% SOC.
  - ! Adjustable upper limit if Time of Use is enabled.

**Gen Exercise Cycle (Day & Time):** Set a weekly generator exercise schedule. (Day of the week/time/duration length). To disable the Gen exercise, adjust the time duration to 0 min.

**Gen Force:** Test function for generator auto-start. Enable and press OK to close normally open relay (pins 7,8) and force the generator on. Disable and press **OK** to disengage. The generator will not provide power during this test if grid power is available.

**Note:** The generator must be in automatic mode, if applicable, and must have a two-wire start (dry-contact, normally open) connected to the Sol-Ark.

## Discharge

**Shutdown:** Battery voltage or % at which the inverter will shut down to protect the battery from an over discharge situation (battery symbol on the home screen will turn red).

**Low Batt:** Low battery voltage or % (battery symbol on the home screen will turn yellow). Stopping point for TOU.

**Restart:** Battery voltage or % at which AC output will resume after previously reaching "shutdown".

**Batt Resistance:** Internal resistance of mOhms from the battery bank. Used in % SOC batt calculations.

**Batt Charge Efficiency:** Value provided by battery manufacturer. Used in % SOC batt calculations.

**Batt Empty V:** Sets the empty voltage and associates this voltage to 0% charge. This value determines the lowest % SOC limit.

**BMS\_Err\_Stop:** Enables system stop when there is loss of battery communications.

 Continuous GEN input/output of 120A (AC amps). DO NOT EXCEED.

## Smart Load

- This mode uses the **GEN** input as a load output that delivers power when the battery exceeds a user programmable threshold or when the Sol-Ark is connected to the grid.
- When  **Use gen input as load output** is enabled, the **GEN** input terminal turns into an output to power high-power loads such as a water heater, irrigation pump, AC unit, pool pump, or any other loads.
- When  **On Grid always on** is enabled, the **GEN** terminal will always output power as long as the grid is connected, regardless of battery charge.

**Smart Load OFF Batt:** Battery voltage or % at which the **GEN** terminal will stop outputting power.

**Smart Load ON Batt:** Battery voltage or % at which the **GEN** terminal will start outputting power.

**Solar Power (W):** Amount of PV production needed before **GEN** terminal starts outputting power.

## AC Coupling Settings - (For AC Coupled Input)

- Grid-tied systems with AC coupled solar arrays must have  **Grid Sell** enabled. Make sure that you are allowed to sell back to the grid.
- To use the **GEN** terminal as an AC coupling input for micro inverters or string inverters, check the box  **For AC Coupled Input to Gen**
- In off-grid systems, the Sol-Ark will use frequency shifting to control the AC coupled solution based on the battery SOC. The meaning of "**Smart Load OFF Batt**" and "**Smart Load ON Batt**" will change in this mode:

**Smart Load OFF Batt:** The % SOC at which the AC coupled inverters turn OFF.  90% recommended.

**Smart Load ON Batt:** The % SOC at which the AC coupled inverters turn ON.  80% recommended.

### To use the **LOAD** terminal for AC coupling microinverters or grid-tied string inverters:

- You must select  **AC couple on load side**.
- The **GEN** terminal **CANNOT** be used. AC coupling on the **LOAD** terminal prevents the use of the **GEN** terminal for any other purpose.
- Wire as shown in diagram 4, "AC Coupling in LOAD." Wiring diagrams start on page 64 .
- Backup Transfer Time is extended to 2 seconds.

## 3.5 Limiter



The Limitless 18K-2P-LV inverter will simultaneously utilize different available power sources to satisfy load demand in the electrical service panels (essential loads panel/main service panel). The following work modes let you determine how generated power is utilized.

### Grid Sell

**Grid Sell:** The inverter will produce as much power as it has available from a DC coupled PV array according to the value programmed here. The maximum power that can be sold to the grid from battery and/or DC PV is 18,000W. The Grid Sell value acts as a limit on the amount of power, including any power from an AC coupled source, that will be exported (sold) to the grid.

**Note:** The **Grid Sell** control cannot limit AC coupled PV sources. If the AC coupled power source meets or exceeds the Grid Sell value, all other sources, such as MPPT and battery, will be curtailed in order to not exceed the programmed Grid Sell value.

### General description

- This mode allows your inverter to sell back to the grid all the excess power generated from the PV arrays without limitation.
- The inverter will show only loads connected to the **LOAD** terminal.
- The inverter will measure all power in or out of the **GRID** terminal as grid consumption or grid sellback.

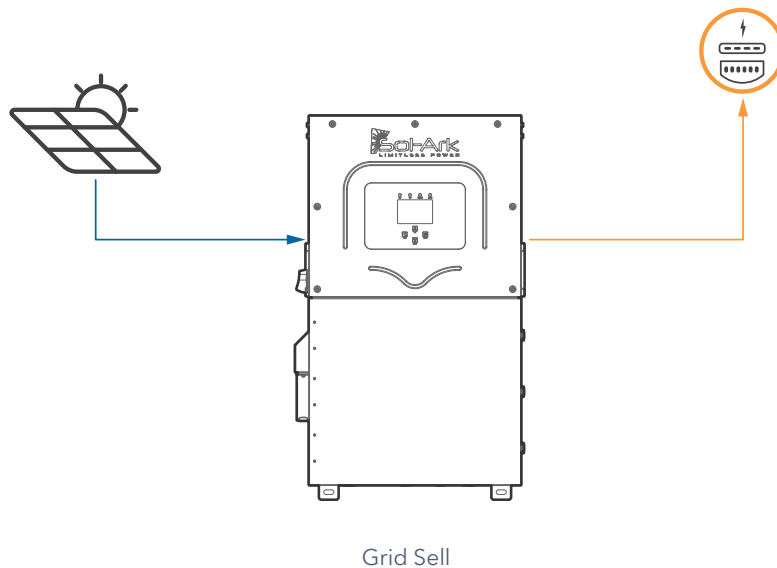

## Limited Power to Home

! This work mode **REQUIRES** batteries

### Limited Power to Home (Meter Zero)

This mode limits the energy produced by the inverter to satisfy the home demand (essential loads panel + main service panel). In this mode, the inverter delivers power to the **LOAD** terminal (essential loads panel) + the **GRID** terminal (main service panel).

CT sensors **MUST** be installed. These sensors measure load consumption in the main service panel to offset total load demand and prevent selling to the utility. This system work mode is useful for users who don't have a permit to sell back. See "

2.9 Limit Sensors (CT sensors)" on page 22 for instructions on installing external CTs.

### General description

1. Power is delivered to the whole home without selling the excess solar back to the grid (this is required if there's no permit to sell back from the utility company).
2. External CT sensors are **required** for proper operation of this system work mode.
3. Monitored loads will be the sum of the main service panel + essential loads panel.
4. **Energy Priority:** 1. Solar PV Power | 2. Grid Power | 3. Batteries | 4. Generator

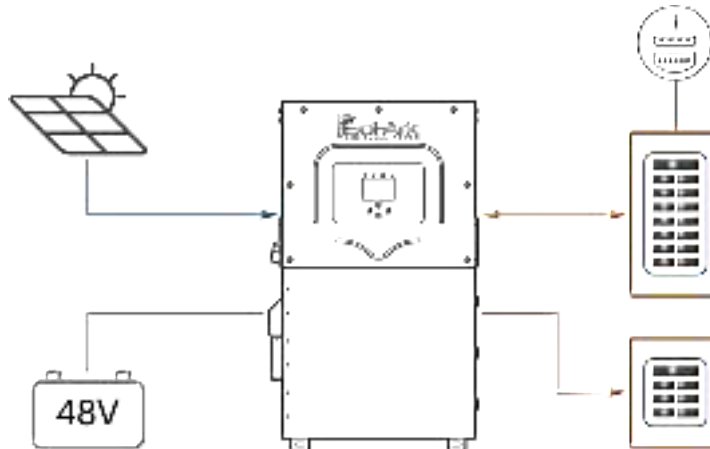

Limited Power to Home

### Limited Power to Home + Grid Sell

This mode will NOT limit solar production to home demand. In this mode, the inverter delivers power to the **LOAD** terminal (essential loads panel) + excess power to the **GRID** terminal (main service panel AND grid).

The Sol-Ark will monitor grid sell and load consumption simultaneously (with +/- 3% error from CT sensors). The CT sensors **MUST** be installed. The inverter will sell excess solar power up to a programmable limit.

See "2.9 Limit Sensors (CT Sensors)" on page 23 for correct placement of external CTs.

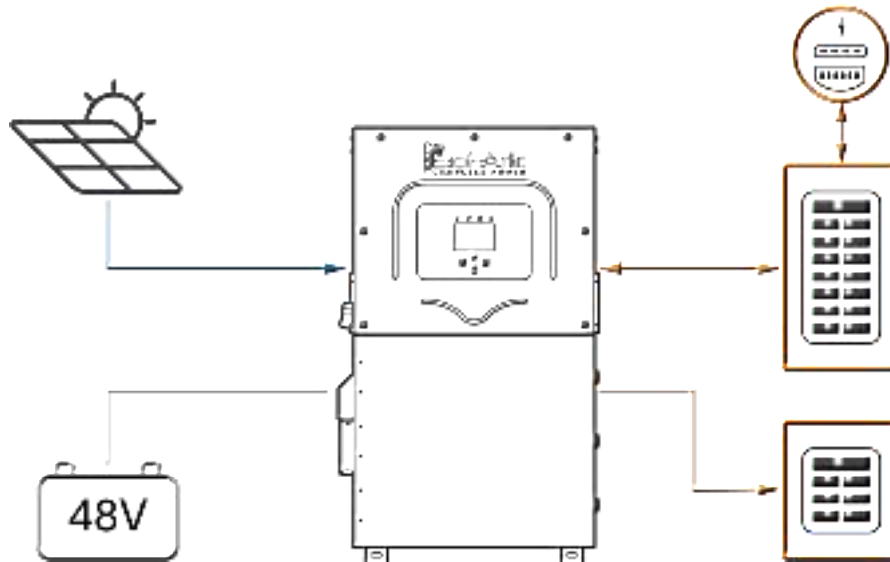

Limited Power to Home + Grid Sell

## Limited Power to Load

! This work mode **REQUIRES** batteries.

Limited Power to Load limits the solar production to cover **LOAD** demand (essential loads panel) exclusively. In this mode, the system disregards loads in the main service panel and will not deliver power to the **GRID** terminal.

### General description

- The inverter will cover only the loads connected to the **LOAD** terminal.
- It will **NOT** produce more power than the load demand.
- This work mode will **NOT** deliver power to the **GRID** terminal (will NOT sell back).
- The loads reported by the inverter will be from only the essential loads panel (**LOAD** terminal).
- This system work mode is recommended for off-grid applications.
- **Energy Priority:** 1. Solar PV Power | 2. Grid Power | 3. Batteries | 4. Generator

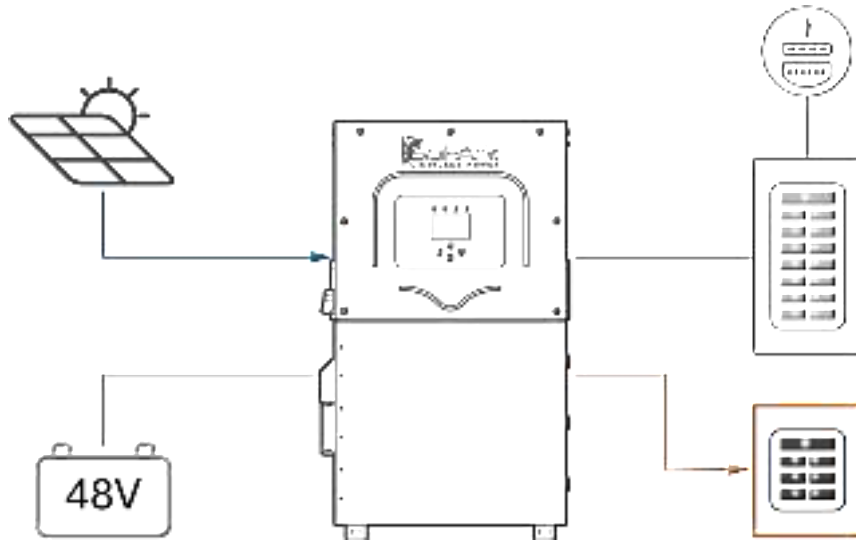

Limited Power to Load

## Limited to Load + Grid Sell

This mode will NOT limit solar production to **LOAD** demand. The inverter delivers power to the **LOAD** terminal (essential loads panel) + excess power to the **GRID** terminal (main service panel AND grid); however, it will track **LOAD** demand and sell excess solar only up to a programmable limit. **GRID** loads cannot be measured, only the total output through the **GRID** terminal. This mode is recommended for single inverter systems or for whole-home backup installations.

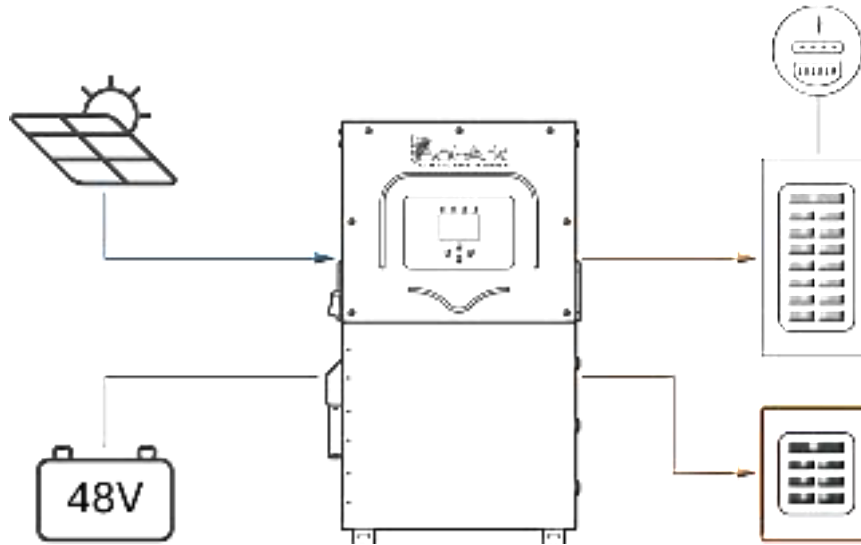

Limited Power to Load + Grid Sell

## Time of Use

This mode combined with **Limited Power to Home** or **Limited Power to Load** lets you use battery backup power to reduce consumption from the grid during specific time intervals. Battery power will cover load demand at a programmable power rate **Power(W)** down to a programmable **Batt (V / %SOC)**. You can configure six different time intervals over a 24-hour period to cover a wide range of battery discharge or charge behaviors.

### General description

- Uses battery power to reduce the power consumption during user defined time intervals.
- Power (W) dictates the rate at which the battery discharges to assist with load demand.
- Batt (V or %) dictates the lower discharge limit or upper charge limit.
- **Energy Priority:**
  1. Solar PV Power | 2. Batteries (down to programmed discharge V or %) | 3. Grid Power | 4. Generator

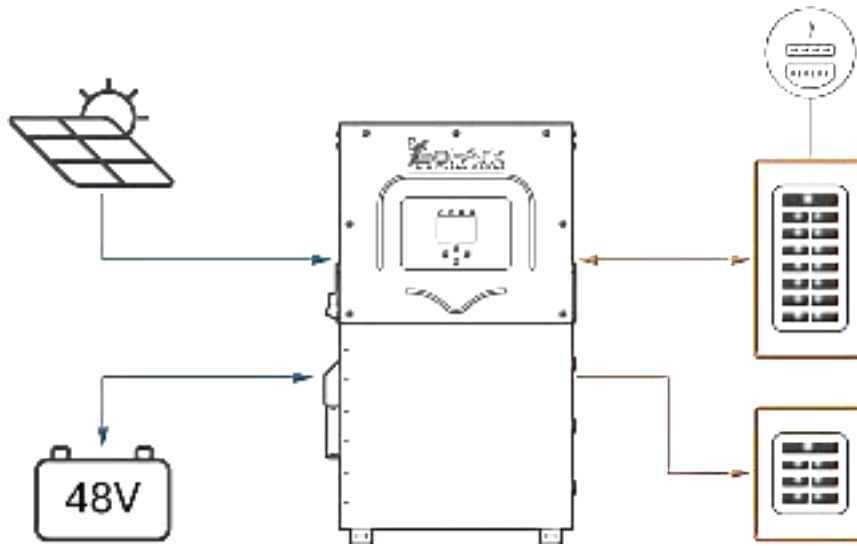

Limited Power to Home + TOU

**Time:** Programmable time intervals over a 24h period. All time slots **MUST** follow chronological order and must be programmed.

**Power(W):** Sets the maximum discharge rate of the battery during the corresponding time slot.

**Batt:** V or % used to specify a lower discharge limit or upper charge limit whenever  **Charge** is enabled.

**!** Grid-tied systems will not allow TOU to discharge lower than **Low Batt V/%**. Off-grid systems allow TOU discharge down to **Shutdown V/%**.

**Charge:** During the hours selected, it is allowed to charge batteries from an external AC source up to a programmed voltage or %. If the external AC power source is a generator, the **Start V** or **Start %** condition must be fulfilled first. If available, the solar array will always charge the batteries at 100% regardless of " **Charge**" in TOU.

**Sell:** Allows batteries to discharge and sell power to the grid at the programmable "Power(W)" rate.

**Grid Sell MUST** be enabled.

**!** Do NOT enable "Charge" and "Sell" at the same time.

## Specify Times for Peak Shaving

To limit Peak Shaving to certain time periods during the day, follow these steps:



1. Go to:  > **Basic Setup** > **Advanced** tab.
2. Select the **Grid Peak Shaving** check box to enable adjustment of the **Power** field.

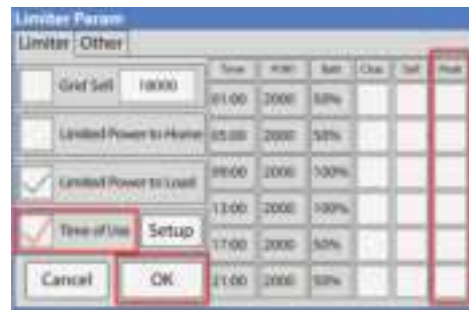

3. To the right of **Grid peak-shaving**, select the **Power** field and use the up and down arrows to set the usage (in watts) from the grid at which the Sol-Ark will begin Peak Shaving.
4. **Uncheck** the **Grid Peak Shaving** check box, then tap **OK**.
5. Tap the **Limiters** button to navigate to the **Limiters** tab on the **System Setup** screen.
6. Select any check boxes under the **Peak** column to specify a time period for grid peak shaving.
7. Select the **Time of Use** check box.
8. Tap **OK** to save the settings and complete programming.



## Other

- **GEN Connect to Grid Input:** Specifies when a generator is connected to the **GRID** terminal.
- **Zero Export Power:** Minimum power imported from the grid. Helps avoid selling back by ensuring constant grid consumption. The value can be set between 1 - 100W (recommended 20W).
- **Batt First:**  Default and recommended option. Sets the solar power priority of the system to charge batteries first. Do NOT change unless instructed by Sol-Ark technical support.
- **Load First:** Sets the solar power priority of the system to cover loads demand first and deliver remaining power to batteries.
  -  This is recommended only for very specific situations.

## 3.6 Grid Setup

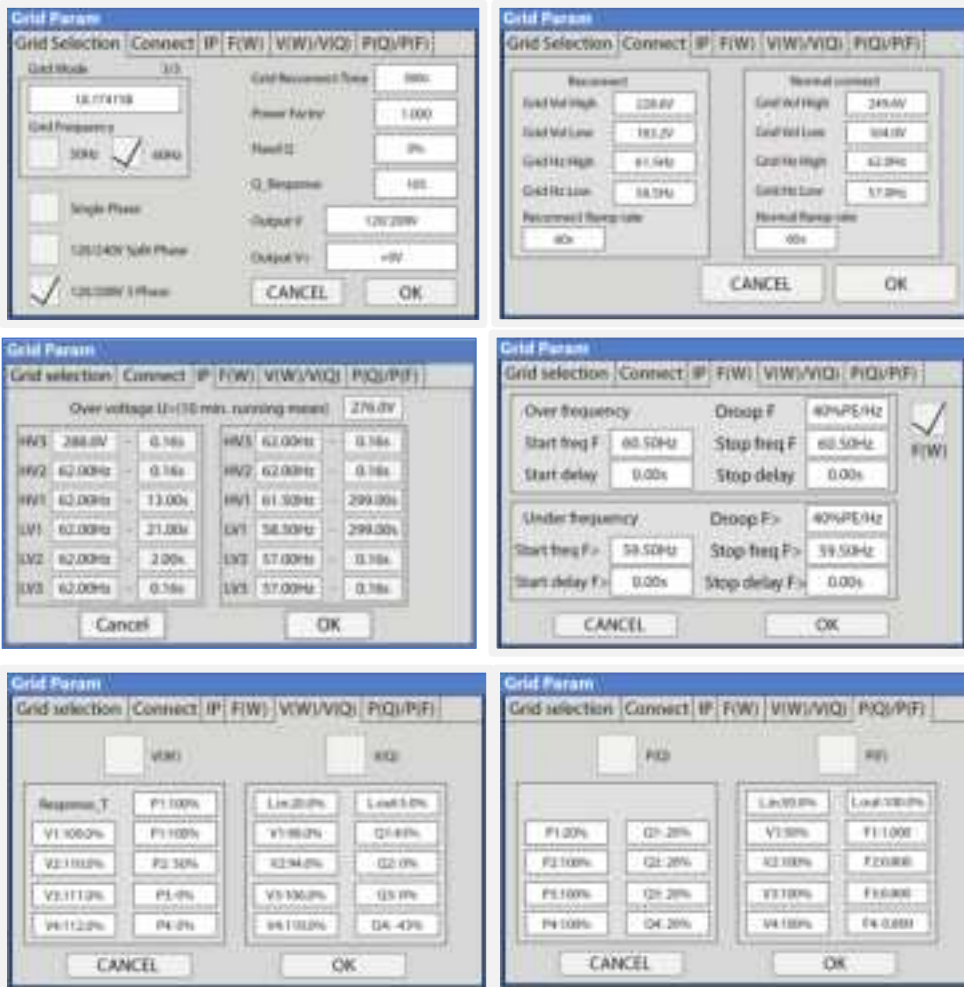

### Grid Selection

**Grid Mode:** Tap and use navigation arrows to cycle through different grid modes:

- **General Standard:** Applies general grid interconnection standards. Enables grid frequency and voltage adjustments. (Useful for off-grid applications with backup generators).
- **UL1741 & IEEE1547:** Applies UL 1741 and IEEE 1547 grid interconnection requirements and standards.
- **UL1741SB:** Applies UL 1741SB grid interconnection requirements and standards.

**Grid Frequency:** Frequency of the AC sine wave.

**Grid Type:** Determines the type of system voltage and grid interconnection. Includes Single Phase, Split-Phase, and 3-Phase.

**Grid Reconnect Time:** The amount of time in seconds the inverter will wait before reconnecting to the grid.

**Power Factor:** Allows for power factor correction,  $\pm 0.9$  to 1.0.

**Fixed Q:** Allows for power factor correction based on desired reactive power percentage.

**Q\_Response:** Response time that will take to follow supported Volt-Var or Watt-Var reactive response modes.

**Output V:** Tap and use navigation arrows to cycle through different nominal grid voltage levels.

⚠ Grid level must be selected according to nominal grid voltage.

**Output V+:** Allows fine voltage modifications to the Output V to ensure proper nominal voltage.

## Connect

**Reconnect:** These parameters determine an allowable range of frequency and voltages for a reconnection to the grid after initial grid loss. Frequency and voltages must be within these margins during Grid Reconnect Time to allow reconnection to the grid.

! Parameters are set automatically based on selected grid mode compliance, unless you select **General Standard**.

**Normal connect:** These parameters determine the allowable range of frequency and voltages to stay connected to the grid after a reconnect and normal operation.

! Parameters are set automatically based on selected grid mode compliance, unless you select **General Standard**.

**Reconnect Ramp Rate:** Reconnection power ramp time in seconds.

**Normal Ramp Rate:** Startup power ramp time in seconds.

## IP

**HV1/HV2/HV3:** Overvoltage protection point.

**LV1/LV2/LV3:** Undervoltage protection point.

**HF1/HF2/HF3:** Over frequency protection point.

**LF1/LF2/LF3:** Under frequency protection point.

## F(W)

**F(W):** Enables using Frequency-Watt. The Sol-Ark regulates its power output to the grid as a function of the frequency to support grid stabilization during periods of over- and under-frequency.

**Droop F:** Percentage of inverter's nominal power increase or decrease per Hertz (Hz).

**Start freq F:** Frequency at which the inverter will start decreasing active power by the programmed Droop F percentage.

**Stop freq F:** Frequency at which the inverter will stop decreasing active power by the programmed Droop F percentage.

## V(W) / V(Q)

**V(W):** Enables using Volt-Watt. The Sol-Ark regulates active power output to the grid as a function of voltage to help with stabilization during over- and under-voltage conditions.

**V(Q):** Enables the use of Volt-VAR. The Sol-Ark regulates reactive power output to the grid as a function of the voltage to support stabilization during periods of over and under-voltage.

**V, P & Q:** Percentage of nominal grid voltage (V) to which the Sol-Ark will reduce its active power (P) or reactive power (Q).

## P(Q) / P(F)

**P(Q):** Enables using Watt-VAR to regulate reactive power output according to programmable active power parameters.

**P(F):** Enables PF regulation according to programmable active power parameters.



! Follow electrical grid code before changing grid settings

## 4. Installation Tips

### 4.1 Off-Grid Installation Tips

1. Limit sensors (CTs) are not required for completely off-grid installations UNLESS using “Grid Peak Shaving” for a generator connected to the **GRID** terminal or installing a parallel inverter system.
2. Connecting generators to the **GRID** terminal is recommended to facilitate the integration **GEN** connected service panel. This setup enables use of the **Smart Load** function.
3. There is no need for a transfer switch. Connect the **LOAD** output to the main panel.
4. **DO NOT** use **Grid Sell** mode when Off-Grid. ONLY **Limited Power to Load** (default work mode) in single inverter systems and **Limited Power to Home** in systems with multiple inverters.
5. When using a Generator in an Off-Grid situation, it’s recommended to change the Grid Mode to “General Standard” and the “Grid Reconnect Time” to 30 seconds. See section “2.5 Integrating a Generator” on page 16 for instructions.
6. The **Auto Gen-Start** activates when the battery voltage (V) or percentage (%) reaches the pre-set **Start V / %** value. Subsequently, the generator will sustain the charging process until the batteries reach approximately 95% capacity.
  - ! This is a non-modifiable upper limit unless Time of Use is enabled and programmed.
    - o An exercise function will turn on the generator once a week on Monday mornings at 8:00 a.m. for 20 minutes by default. This exercise is done to maintain the internal generator batteries.
7. If you plan to integrate a wind turbine, you MUST incorporate a 48V charge controller with a dump load to prevent battery overcharge. This charge controller must be connected directly to the battery bank.
8. Remember to set the battery capacity and reasonable charge/discharge rates.

### 4.2 Grid-Tie and No Battery Install Tips (Passthrough mode)

1. Check the “ No Battery” setting:  > **Battery Setup** > **Batt** > **No Battery**. The inverter will fault momentarily.
  - ! A complete **Power Cycle IS REQUIRED** when changing the battery mode to **No Battery**. See “2.12 Power Cycle Sequence” on page 30 for instructions.
2. Enable  **Grid Sell**:  > **Limiter** > **Grid Sell**. *Be sure to disable all other modes.*
3. **DO NOT** check the **Parallel** check box in systems with multiple inverters and no battery bank.  
**Settings:** > **Basic Setup** > **Parallel Tab** > **Parallel**
4. Tap the battery Icon to access the **Details** screen and verify grid parameters and power import/export.

## 4.3 Battery Charge Controller

### 4-Stage Charging

The MPPT has a 4-stage battery charging algorithm for rapid, efficient, and safe battery charging. The figure shows the stage sequence.

**Note:** If you are not using closed-loop communications, the inverter will follow the stages below.

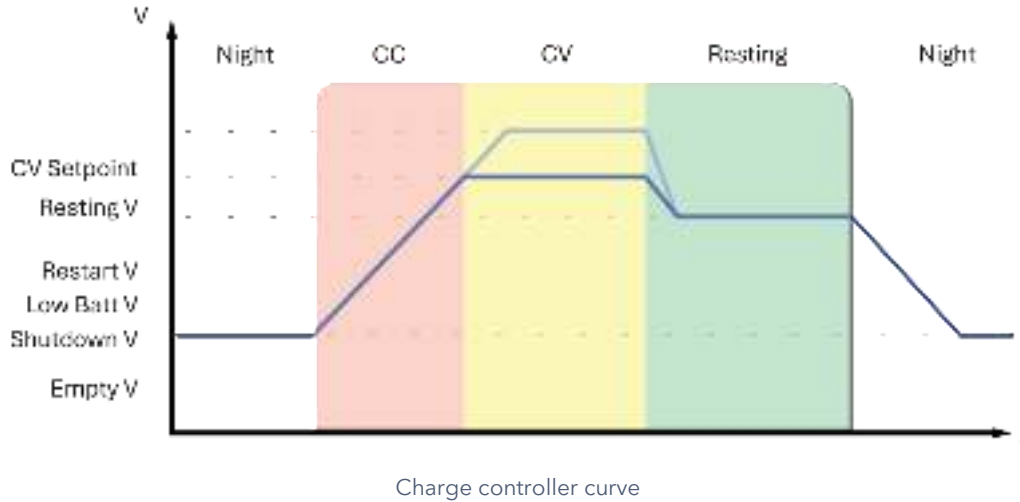

### Bulk Charge Stage (CC)

In the Bulk Charge stage, the battery is not at a 100% state of charge and has not yet reached the Absorption voltage setpoint. The controller will deliver 100% of available solar power to recharge the battery.

### Absorption Stage (CV)

When the battery has reached the absorption voltage setpoint, the Sol-Ark inverter uses constant-voltage regulation to maintain battery voltage at the absorption setpoint, preventing overheating and excessive battery gassing. The battery is allowed to come to a full state of charge at the absorption voltage setpoint. Absorption lasts until the battery charge amperage (A) rate reaches 2% of the programmed capacity (Ah).

### Float Stage (Resting)

After the Absorption stage charges the battery fully, the MPPT reduces the battery voltage to the float voltage setpoint. If the batteries have 100% charge, there can be no more chemical reactions, and all the charging current turns into heat and gassing. The Float stage provides a minimum rate of maintenance charging while reducing the heating and gassing of a fully charged battery. The purpose of the Float stage is to protect the battery from long-term overcharge.

## 4.4 Local Grid Compliance Settings

See the application note "[Local Grid Compliance Settings](#)" on the [Sol-Ark Knowledge Hub](#) for required settings for Hawaii and Puerto Rico.

## 5. Parallel Systems

### 5.1 Before Enabling Parallel Operations

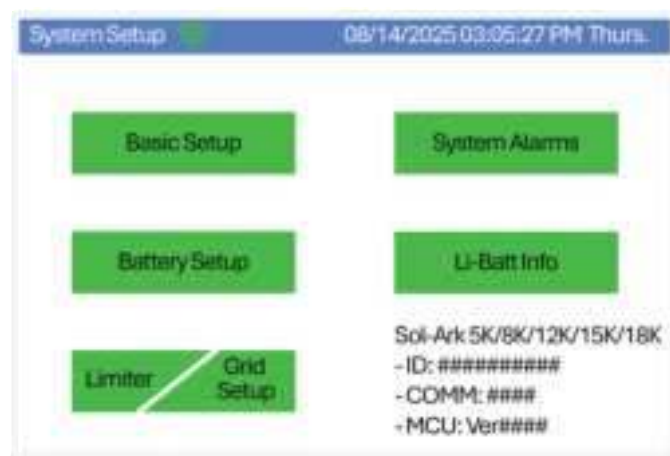

- A. Make sure all units in parallel have the same software version by verifying the **COMM** and **MCU** numbers on the **System Setup** screen.
- B. Go to <https://www.sol-ark.com/software-update/> to schedule an update or contact Sol-Ark Technical Support for help at: [support@sol-ark.com](mailto:support@sol-ark.com)
- ⚠ Parallel systems **REQUIRE** a joint battery bank. If you do not have a battery, keep all Sol-Ark inverters **OUT** of parallel and set every System to **Grid Sell** Mode.
- ⚠ For systems with no battery, do NOT check the **Parallel** box on operation:  
 ⚙ > **Basic Setup** > **Parallel** >  **Parallel**.
- C. All INPUTS/OUTPUTS must be shared among **ALL** parallel inverters, except for DC solar inputs.

## DIP Switch Configuration for Parallel Systems

In parallel systems, set the “DIP Switches” as shown, according to the table below.

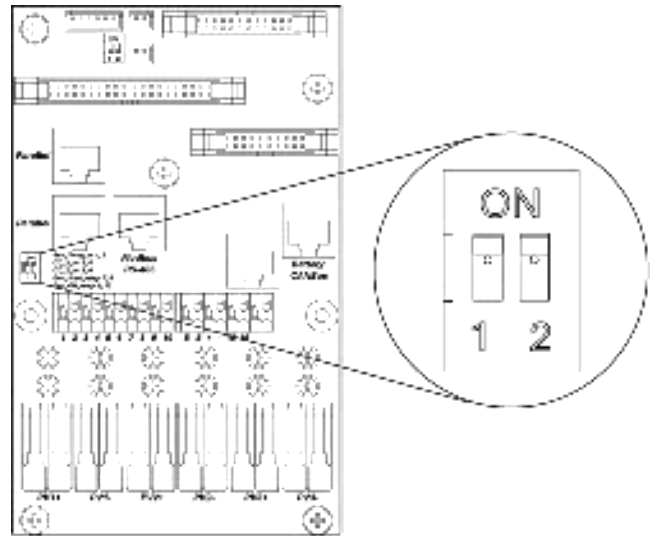

RJ-45 Port Configuration

| Inv 1 (Master) | Inv 2       | Inv 3 | Inv 4 | Inv 5 | Inv 6 | Inv 7 | Inv 8 | Inv 9 | Inv 10 | Inv 11 | Inv 12 |
|----------------|-------------|-------|-------|-------|-------|-------|-------|-------|--------|--------|--------|
| OFF            |             |       |       |       |       |       |       |       |        |        |        |
| <b>!</b> ON    | <b>!</b> ON |       |       |       |       |       |       |       |        |        |        |
| OFF            | ON          | OFF   |       |       |       |       |       |       |        |        |        |
| OFF            | ON          | ON    | OFF   |       |       |       |       |       |        |        |        |
| OFF            | ON          | ON    | ON    | OFF   |       |       |       |       |        |        |        |
| OFF            | ON          | ON    | ON    | ON    | OFF   |       |       |       |        |        |        |
| OFF            | ON          | ON    | ON    | ON    | ON    | OFF   |       |       |        |        |        |
| OFF            | ON          | ON    | ON    | ON    | ON    | ON    | OFF   |       |        |        |        |
| OFF            | ON          | ON    | ON    | ON    | ON    | ON    | ON    | OFF   |        |        |        |
| OFF            | ON          | ON    | ON    | ON    | ON    | ON    | ON    | ON    | OFF    |        |        |
| OFF            | ON          | ON    | ON    | ON    | ON    | ON    | ON    | ON    | ON     | OFF    |        |
| OFF            | ON          | ON    | ON    | ON    | ON    | ON    | ON    | ON    | ON     | ON     | OFF    |

**!** Parallel systems with 2 inverters must have their DIP switches in the ON position.

### Parallel Systems Limitless 18K-2P-LV @ 120/240V Split-Phase

| x  | Continuous output power with PV (kW) | Continuous output power with batteries (kW) | Max. Grid Passthrough Current (A) | Peak power 10 sec (kVA) |
|----|--------------------------------------|---|-----------------------------------|-------------------------|
| 1* | 18                                   | 18  | 200                               | 36                      |
| 2  | 36                                   | 36  | 400                               | 72                      |
| 3  | 54                                   | 54  | 600                               | 108                     |
| 4  | 72                                   | 72  | 800                               | 144                     |
| 5  | 90                                   | 90  | 1000                              | 180                     |
| 6  | 108                                  | 108   | 1200                              | 216                     |
| 7  | 126                                  | 126   | 1400                              | 252                     |
| 8  | 144                                  | 144   | 1600                              | 288                     |
| 9  | 162                                  | 162   | 1800                              | 324                     |
| 10 | 180                                  | 180   | 2000                              | 360                     |
| 11 | 198                                  | 198   | 2200                              | 396                     |
| 12 | 216                                  | 216   | 2400                              | 432                     |



## Parallel Systems Limitless 18K-2P-LV @ 120/208V 3-Phase

| # of inverters in parallel    | Continuous output power (kW) | Continuous output power with batteries (kW) | Grid Passthrough (A) | Peak power 10 sec (kVA) |
|-------------------------------|------------------------------|---|----------------------|-------------------------|
| 1 (only 2 phases) *           | 15.6                         | 15.6  | 200                  | 31.2                    |
| 2 (all phases but unbalanced) | 31.2                         | 31.2  | 400                  | 62.4                    |
| 3                             | 46.8                         | 46.8  | 400                  | 93.6                    |
| 6                             | 93.6                         | 93.6  | 800                  | 187.2                   |
| 9                             | 140.4                        | 140.4                                       | 1200                 | 280.8                   |
| 12                            | 187.2                        | 187.2                                       | 1600                 | 374.4                   |

\* For single-inverter systems, enabling the **Parallel** option on the **Parallel** tab is not required. Select the appropriate grid type and voltage for your application (such as split-phase, three-phase, etc.).

## 5.2 Parallel Systems Programming Sequence

1. Program each inverter for parallel operation: **☛ > Basic Setup > Parallel > ☑ Parallel**
2. Assign the "Slave" unit as | **Modbus SN: 2,3,4...** etc.
3. Assign a "Master" inverter, **Modbus SN: 1.**
4. If a system is 3-Phase, there **MUST** be a "Master" for each phase (**Master Phase A, Master Phase B, Master Phase C**)
5. Connect communication cables between the inverters using the RJ45 cable (yellow ethernet cable) in daisy-chain configuration between ports: Parallel\_1 or Parallel\_2 from "Master" to "Slave" or "Slave" to "Slave."
6. Perform a power cycle (see "2.12 Power Cycle Sequence" on page 30).
7. After the power cycle is completed, turn on the "Slave" units **FIRST**. Then turn ON the "Master" **LAST**.
8. Inverters will likely fault momentarily with F29 and F41 codes until all inverters are ON.

**!** When integrating a generator, it must be connected to all the systems in parallel. The inverter assigned as "Master" will control the two-wire start feature.



Parallel setup tab

### Parallel Configuration (Example on a 3 Phase System-Balanced). Phase A-B-C

A 3-Phase balanced system requires at least 3 Sol-Ark Units. Follow the illustrations below for programming and wiring.

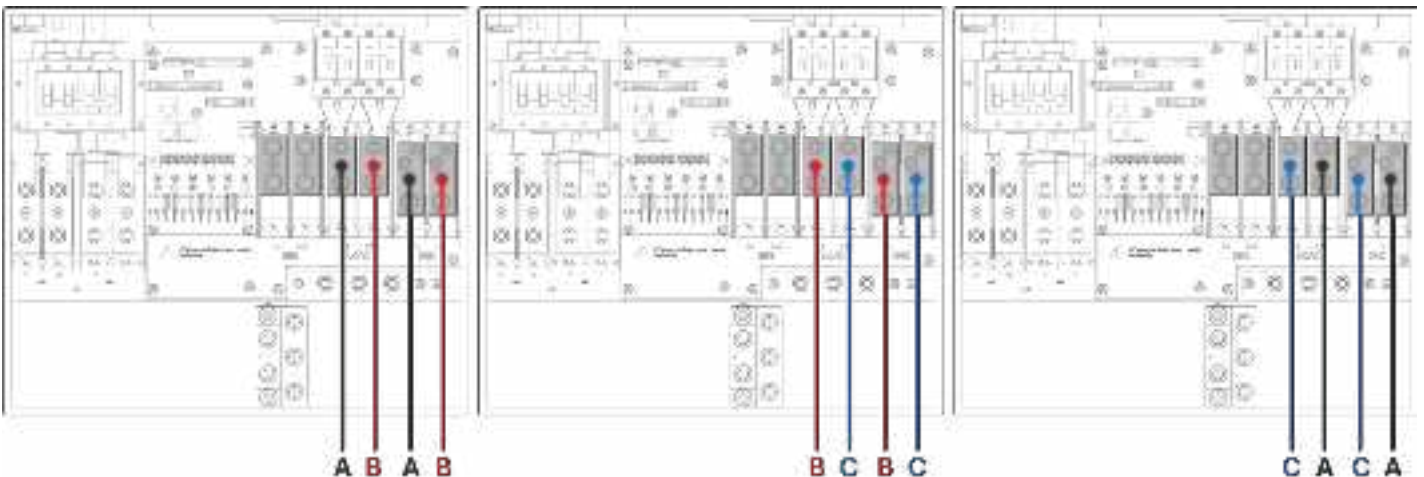

## Examples of 3-Phase Parallel Configurations

2 inverters @ 120/208V using **2 phases of 3**

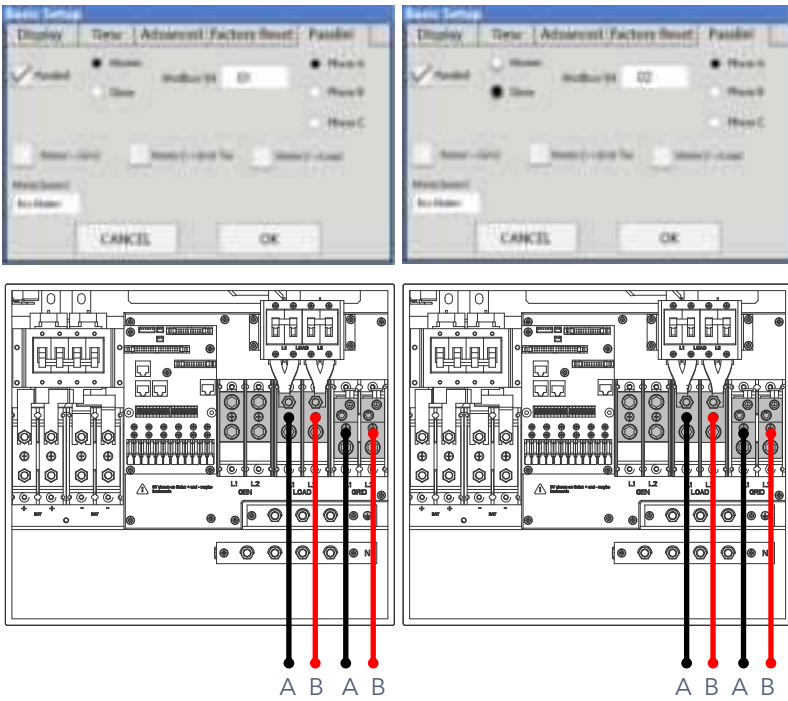

2 inverters @ 120/208V using 3 phases of 3 (Unbalanced)



## 5.3 Three-Phase Systems

Three-phase systems with multiple Sol-Ark inverters must be programmed according to this table:

| Number of inverters | Programming  |
|---------------------|--|
| 2                   | Master Phase A 01   Master Phase B 02  |
| 3                   | Master Phase A 01   Master Phase B 02   Master Phase C 03  |
| 6                   | Master $\Phi$ A 01, Slave $\Phi$ A 02   Master $\Phi$ B 03, Slave B 04   Master $\Phi$ C 05, Slave $\Phi$ C 06   |
| 9                   | Master $\Phi$ A 01, Slave $\Phi$ A 02, Slave $\Phi$ A 03   Master $\Phi$ B 04, Slave $\Phi$ B 05, Slave $\Phi$ B 06   Master $\Phi$ C 07, Slave $\Phi$ C 08, Slave $\Phi$ C 09       |
| 12                  | M $\Phi$ A 01, S $\Phi$ A 02, S $\Phi$ A 03, S $\Phi$ A 04   M $\Phi$ B 05, S $\Phi$ B 06, S $\Phi$ B 07, S $\Phi$ B 08   M $\Phi$ C 09, S $\Phi$ C 10, S $\Phi$ C 11, S $\Phi$ C 12 |

### Troubleshooting Guide with Phase Sequence

**⚠** If the screen of the Sol-Ark inverter shows the error shown below, ensure the phase sequence follows **AB-BC-CA** convention. The message "Grid Phase Wrong" is displayed when the inverter does not detect the correct phase sequence. This situation can cause overloads faults in the system (F18, F26, F34) even with the **LOAD** disconnected and **WILL CAUSE DAMAGE** to the equipment if it is not corrected.

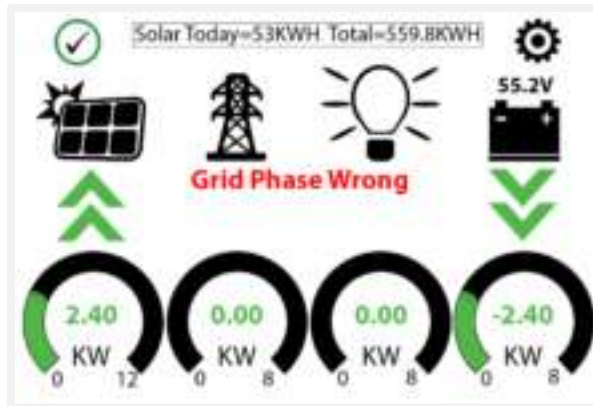

|              | L1 | L2 |
|--------------|----|----|
| Inverter (1) | A  | B  |
| Inverter (2) | B  | C  |
| Inverter (3) | C  | A  |

## How to find an incorrect phase if so see the message “Grid Phase Wrong”

- Measure L1 GRID of inverter (1) to L2 GRID of inverter (3). Should be 0Vac.
- Measure L2 GRID of inverter (1) to L1 GRID of inverter (2). Should be 0Vac.
- Measure L2 GRID of inverter (2) to L1 GRID of inverter (3). Should be 0Vac.
- Same process should be done for LOAD side.
- Measuring voltage different than 0Vac means the measured lines are not the same phase.
- **Sol-Ark can only receive direct rotation “G” (clockwise).**

Be sure to check both **GRID** and **LOAD** terminal connections; both must be correct. If the error persists, check your AC connection beyond the inverter and verify that the phases are correctly labeled from your meter.

**\*In 3-phase systems, it’s recommended to use a rotational tester (1-2-3, A-B-C).**

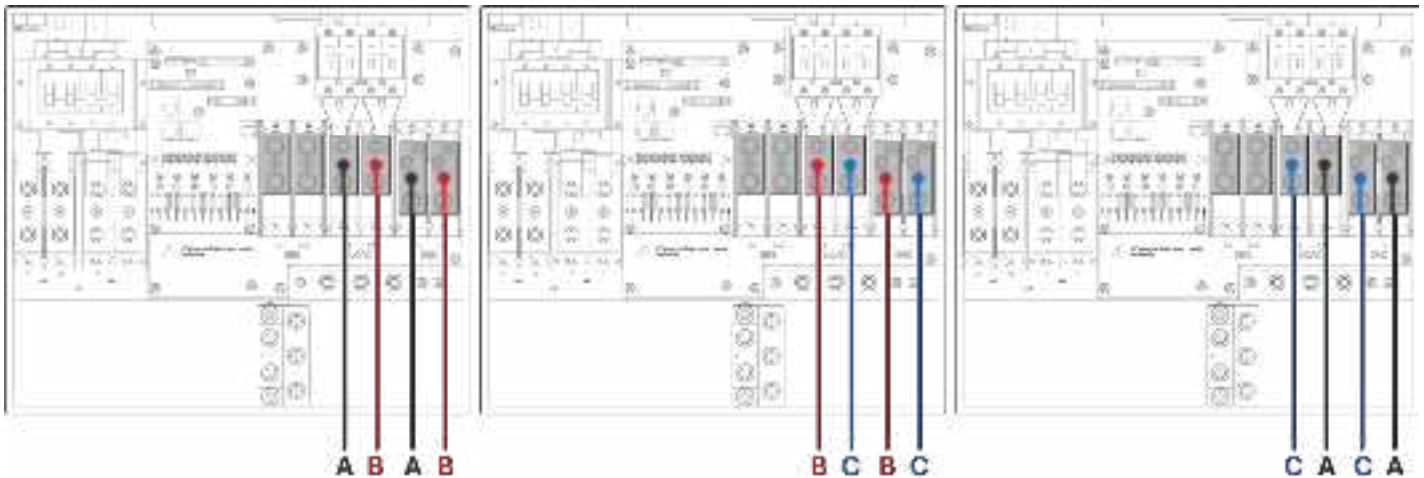

If an inverter goes into a fault state, all other units will stop and follow. The system will automatically self-reboot. If the system faults 5 consecutive times, it will stop completely and it will require a manual restart. See “2.12 Power Cycle Sequence” on page 30.

## 6. MySolArk: Remote Monitoring



**MySolArk** is a powerful and comprehensive tool designed for remote system monitoring of Sol-Ark inverters and solar systems. This remote monitoring solution offers detailed insights into energy generation and power consumption, allowing users to track system performance with great precision. MySolArk displays all relevant electrical data on easy-to-understand energy generation graphs, providing a comprehensive overview of electrical usage.

Beyond its monitoring capabilities, **MySolArk** offers users the flexibility to remotely adjust inverter settings, allowing them to seamlessly configure their system from any location. This ensures that users can fine-tune parameters to optimize performance effortlessly. With **MySolArk**, users can confidently manage their solar systems and inverters to ensure peak performance and efficiency at all times. Visit [www.mysolark.com](http://www.mysolark.com) to access the desktop version of MySolArk.

### 6.1 Setting Up MySolArk

#### Connect to MySolArk through Ethernet

- A. Remove the plastic enclosure of the dongle by pressing the plastic latches with a flat screwdriver as shown in the figure below.
- B. Insert the ethernet cable through the plastic enclosure and connect the cable to the RJ45 port.
- C. Reassemble the dongle housing and plug the dongle into the Sol-Ark, securing it with screws. You'll see solid red and green lights after a couple of minutes.
- D. Follow the Step 1 instructions below to create a plant on MySolArk.



#### Connect to MySolArk through Wi-Fi

- A. Plug the Wi-Fi dongle into the Sol-Ark DB-9 port.
- B. Use two M4X10 screws to secure the dongle to the port.
- C. Follow Steps 1-3 in order to:
  - a. Create a plant on the MySolArk monitoring platform.
  - b. Connect the dongle to MySolArk through a Wi-Fi network.

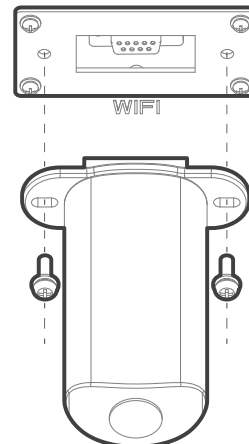

## Step 1: Create a Plant on MySolArk

A. Download and install the MySolArk\_app for Android or Apple smartphones. You can use the QR codes below.



B. Create a **MySolArk** account and log in.

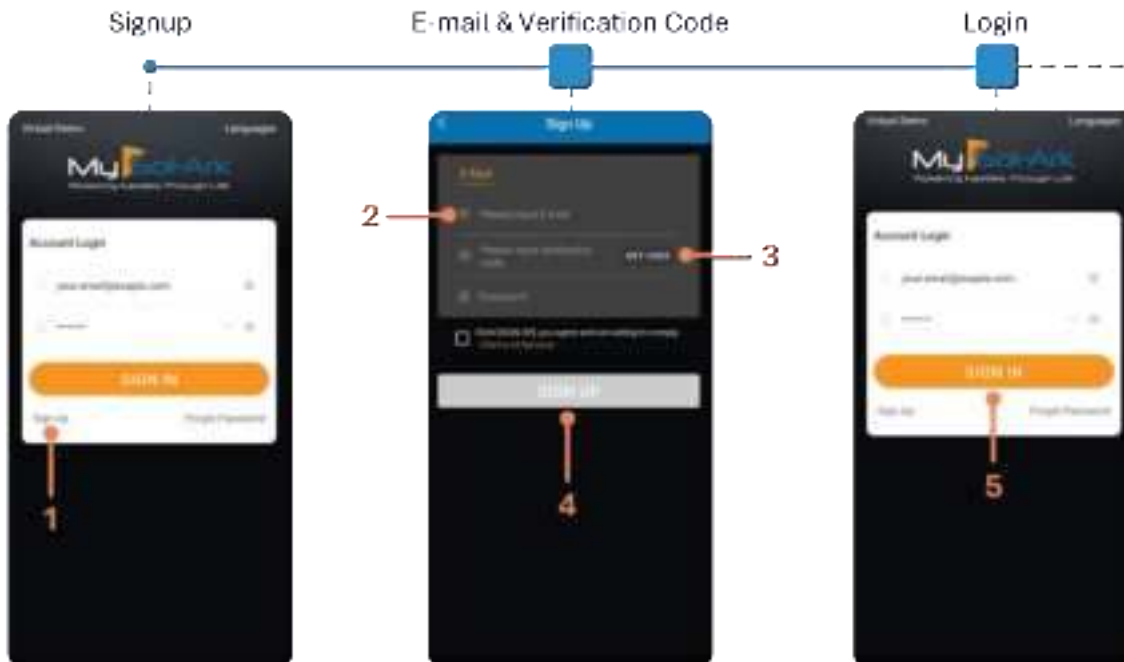

C. Create the Plant.

**For Installers:**



Create the plant and configure the system before sharing it with the owner.

After creating and configuring the plant, share and grant manager permissions to the owner by navigating to **My Plants > ... > Share > Add Account**". The homeowner must create their own **MySolArk** account first.

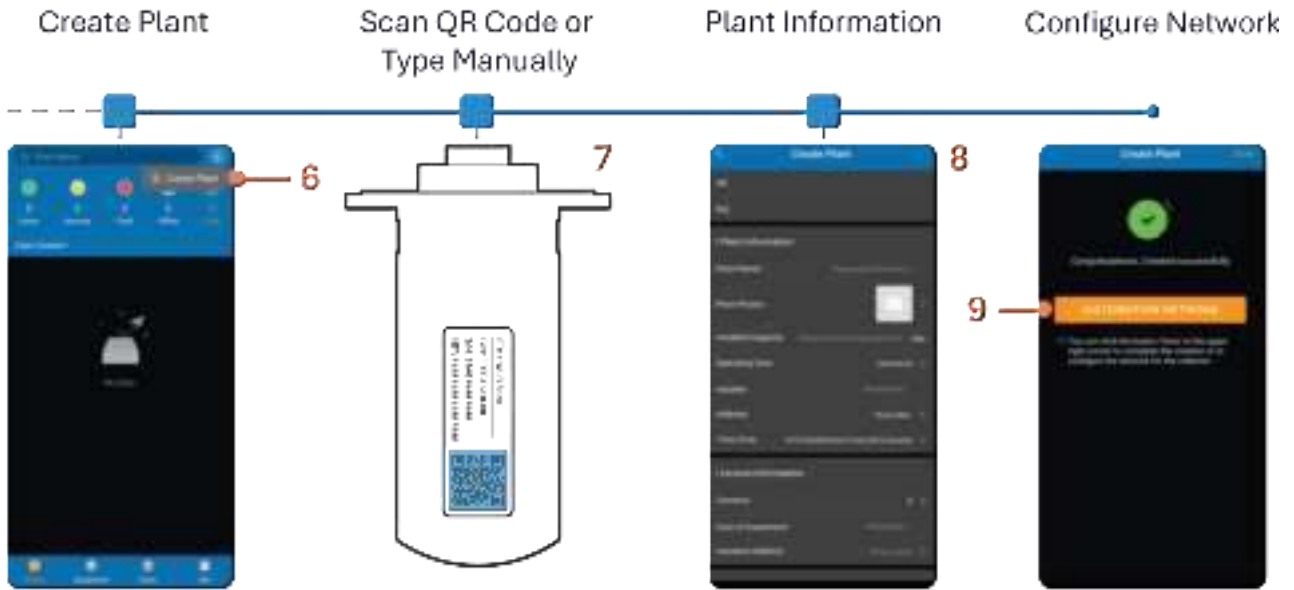

## Step 2: Configure Wi-Fi network through MySolArk

D. Follow the diagram below to configure the Wi-Fi network.

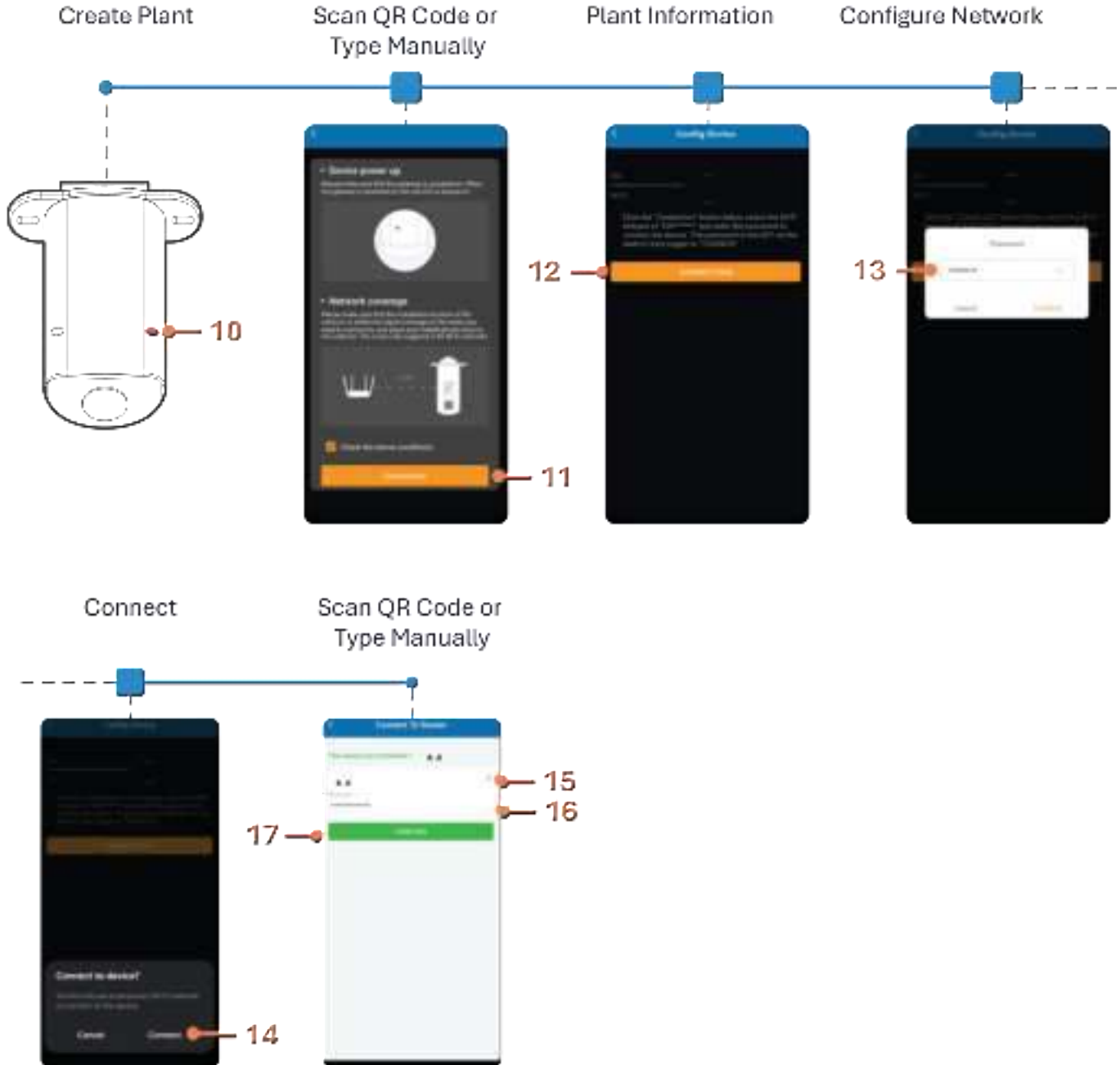

**Note:** You can access the Wi-Fi configuration tool at any other time by tapping **Me** at the bottom right corner, then **Tools > Wi-Fi configuration**. Step 3 shows another method of connecting the Wi-Fi dongle to a local network through an IP address.

### Step 3 (alternate method): Configure Wi-Fi Network using an IP Address

An alternative to the “Distribution Network” configuration at the end of Step C, or using the “Wi-Fi configuration” tool, you can configure a Wi-Fi network through an IP address.

- A. On a Smart Phone or Computer, connect to the **EAP-#####** network.  
Go to: **Settings > Wi-Fi > EAP-##### network**.
- B. Type in the password, which depends on the product you received:
  - If you see “**KEY**” printed on the dongle, the 16-digit password is printed there
  - If there is no “**KEY**” printed on the dongle, the password is **12345678**

The EAP-##### network contains the last 5 digits of the Dongle serial number. You can find this number on the label.

- C. A message such as “Connected without internet” appears when the device is connected to the EAP-#####.

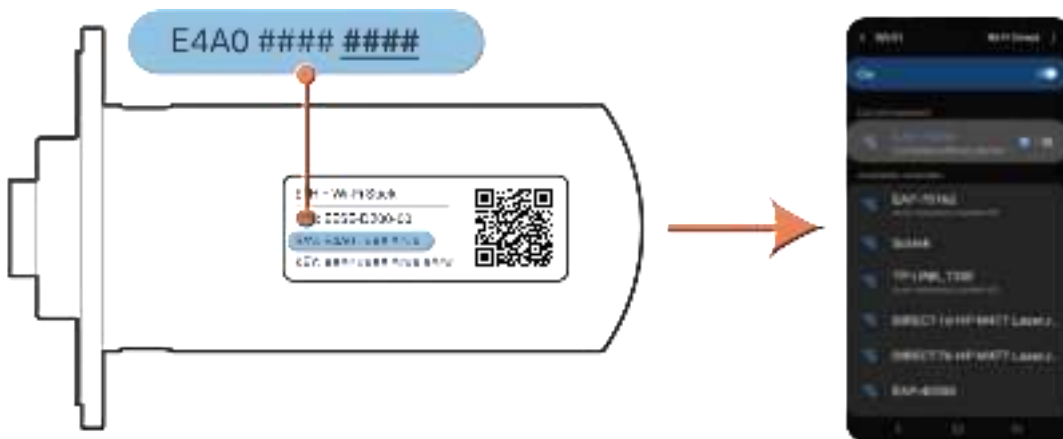

Locating the Dongle Network Name

**Note:** The Wi-Fi dongle does NOT provide internet access. It needs an external internet provider to connect to. The dongle is compatible with Wi-Fi signal broadcast at 2.4 GHz (it is not possible to use 5 GHz)

- D. After you’re connected, open an internet browser on the same device, such as Safari, Chrome, Firefox, Edge, or any other browser.
- E. On the address bar (**http://.....**), type the IP address: **10.10.10.1** as shown in the figure below. If you cannot access the configuration page, try again on a different device.
- F. Scroll down to the **Wlan Connection** section and tap the **Scan** button to scan for local Wi-Fi networks.
- G. Nearby Wi-Fi networks will appear. Select the local network you would like to connect to, input your credentials, and tap **Connect**.
- H. Once connected, a “Connection Successful” message appears. Tap the **Save** button next to **Scan** to save settings.
- I. Wait a few minutes. The dongle will connect to the Wi-Fi network, and you’ll now have access to **MySolArk**.

**Note:** **DO NOT** connect to the **EAP-#####** network, as that is the Wi-Fi dongle itself. The device does not provide internet access.



a. Internet Browser IP Address

b. Wi-Fi Network Scan

If the connection is successful, you'll see these LED indicators.

- **SOLID:** Connected and powered by the Sol-Ark inverter.
- **SOLID:** Connected to the router and to MySolArk.
- **INTERMITTENT:** Connected to the router but not to the server (usually a VPN or Firewall problem). Ports 80 and 51100 must be populated.

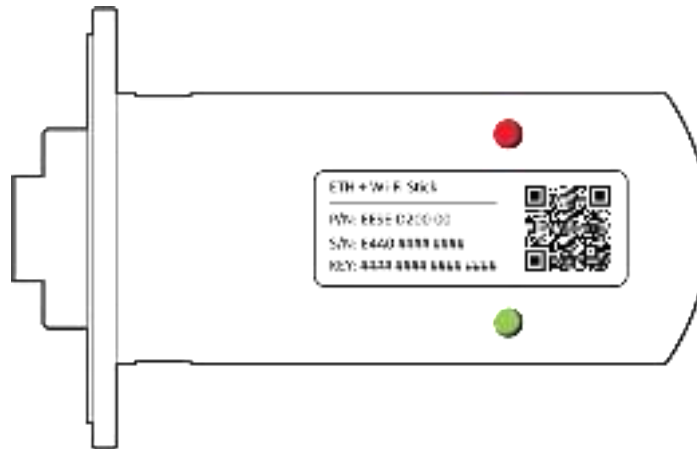

Wi-Fi Dongle LED Indicators





! Connecting through the 10.10.10.1 IP address is only meant to provide internet access to the Wi-Fi dongle. Users must still create a MySolArk account and must create a Plant. Go to [www.mysolark.com](http://www.mysolark.com) to access the desktop version of MySolArk.

## 6.2 LED Indicator and Troubleshooting

When both the red and green LEDs on the Wi-Fi dongle are consistently illuminated, it signifies normal operation, while flashing indicates data transmission. If this isn't the case, reference the next table of LED indications for troubleshooting and corrective measures.

 **RED LED:** Device communication indicator.

 **GREEN LED:** MySolArk server communication indicator.

| LED   | State  | Meaning   |
|---|--|---|
|    | Initial flashing, then constant illumination | Normal communication.   |
|   | Initial flashing but no further illumination | Communication failure. Check proper device connection.  |
|   | LED not illuminating                         | Power supply or device is abnormal. Contact Sol-Ark Technical Support.  |
|    | 5 second illumination interval               | Normal communication.   |
|   | 1 flash every minute                         | Router not connected.   |
|   | 3 flashes every minute                       | Connected to router but no internet access. Usually, a VPN or firewall issue. Ports 80 and 51100 must be enabled. |
|   | 4 flashes every minute                       | Device communication error. Contact support.  |
|   | 2 synchronized flashes                       | Ethernet cable inserted.  |
|  | 3 synchronized flashes                       | Ethernet cable disconnected.  |

## 7. Wiring Diagrams



The following diagrams are general use cases. Installers are reminded that adherence to local electrical codes and regulations is mandatory. While these diagrams offer general guidance, they may not encompass all variations and specifics required by local codes. Consult with relevant authorities and ensure compliance before proceeding with any installation. The diagrams presented herein are not exhaustive and should not be relied upon solely for permitting or warranty verification. Installers are encouraged to exercise caution, seek professional advice when necessary, and undertake installations with due diligence and in accordance with established electrical standards and regulations.



## 7.2 Standard Wiring Diagram - Line Side Tap

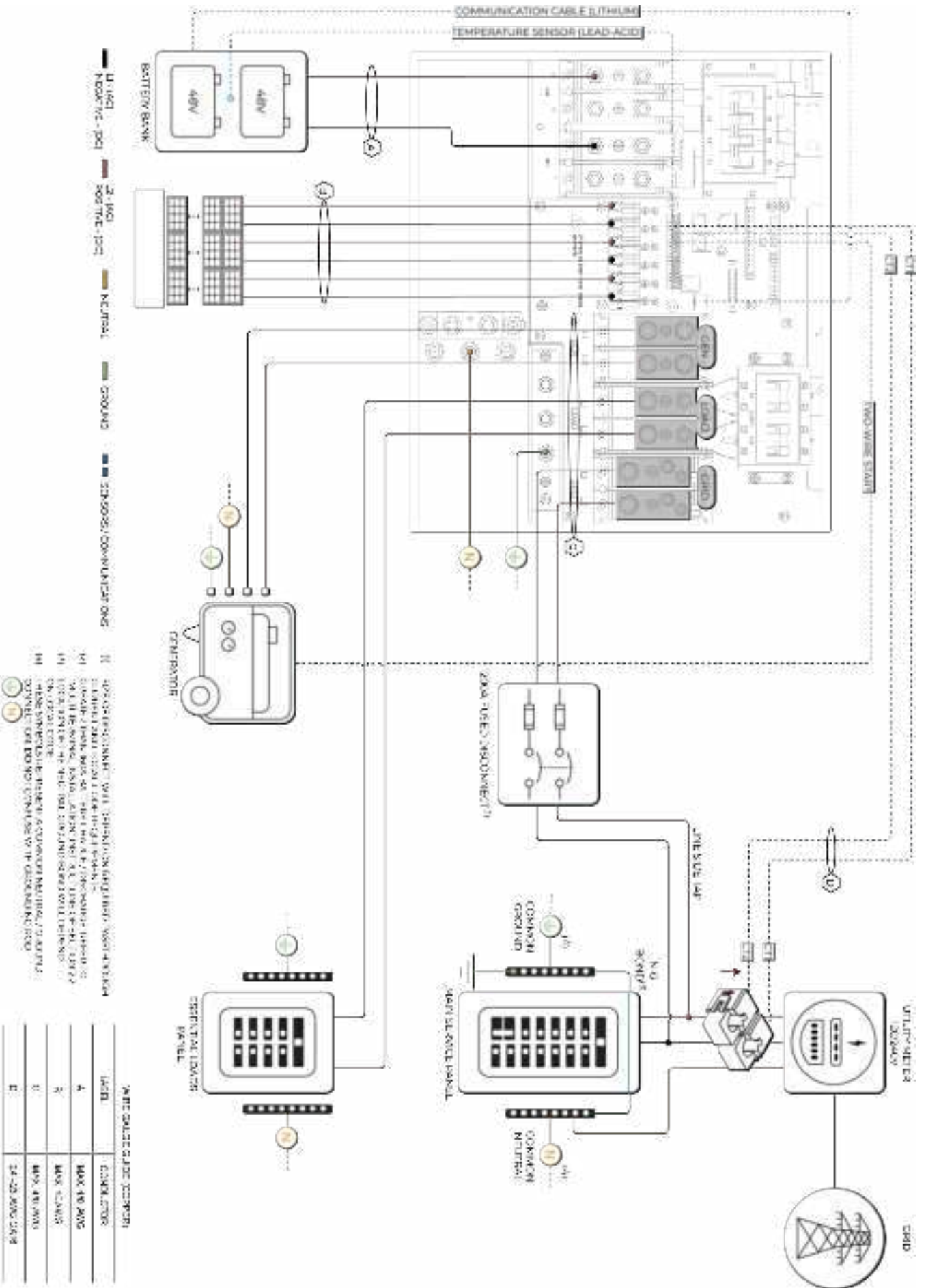
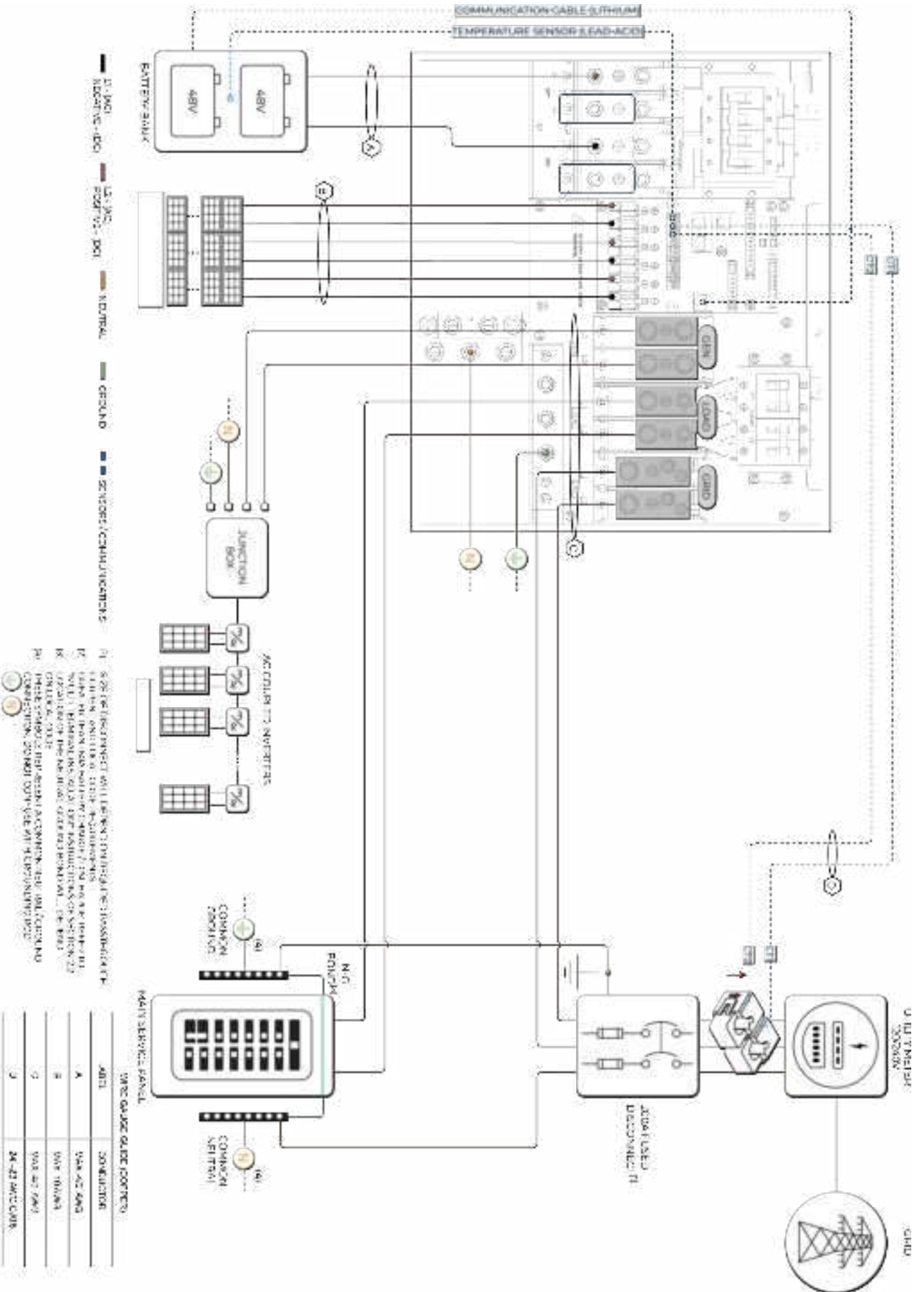

Diagram 02

## 7.3 Standard Wiring Diagram – AC Coupling in GEN





# 7.5 Standard Wiring Diagram - Whole-Home Generator

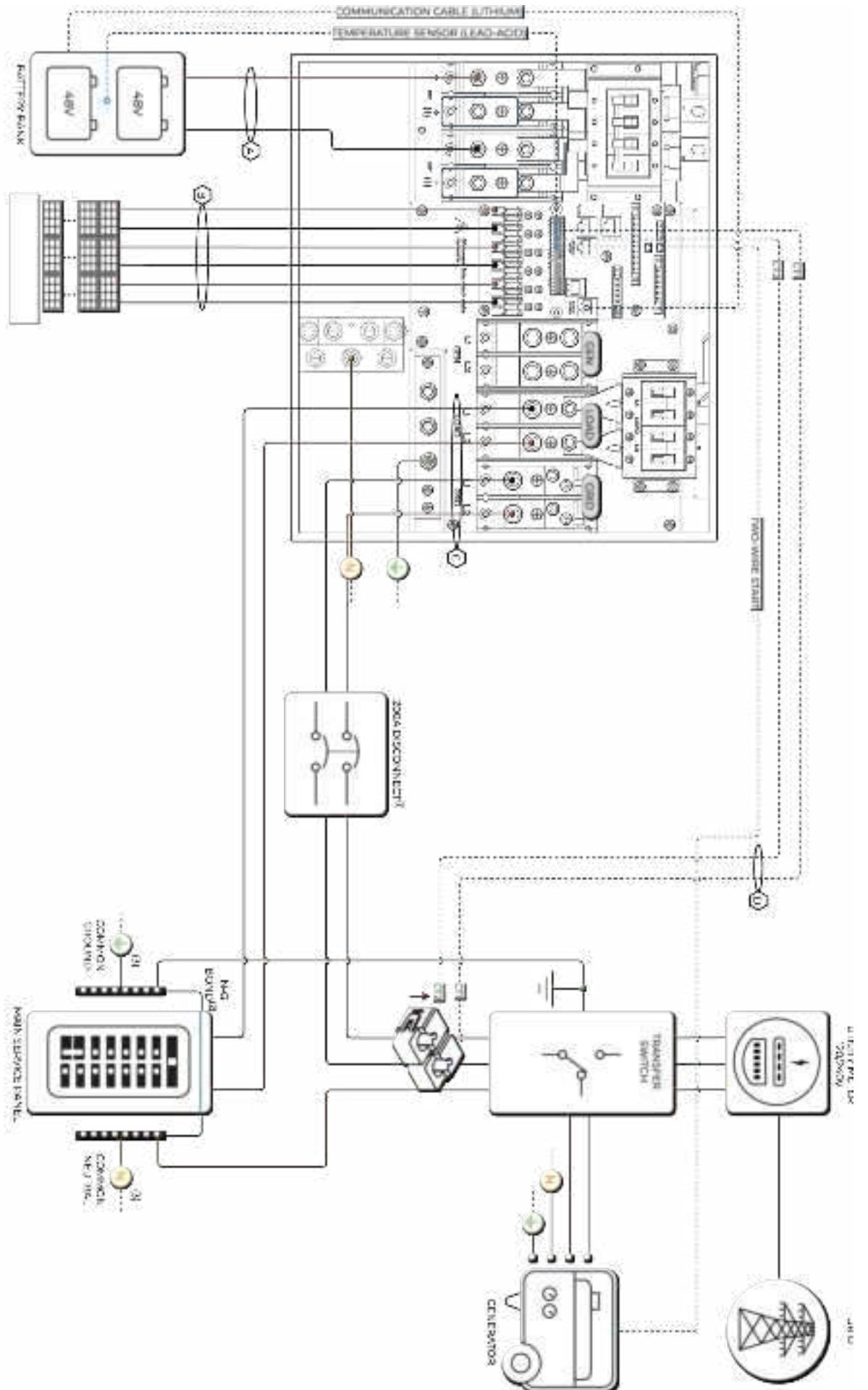

Diagram 05

# 7.6 Standard Wiring Diagram - Off Grid

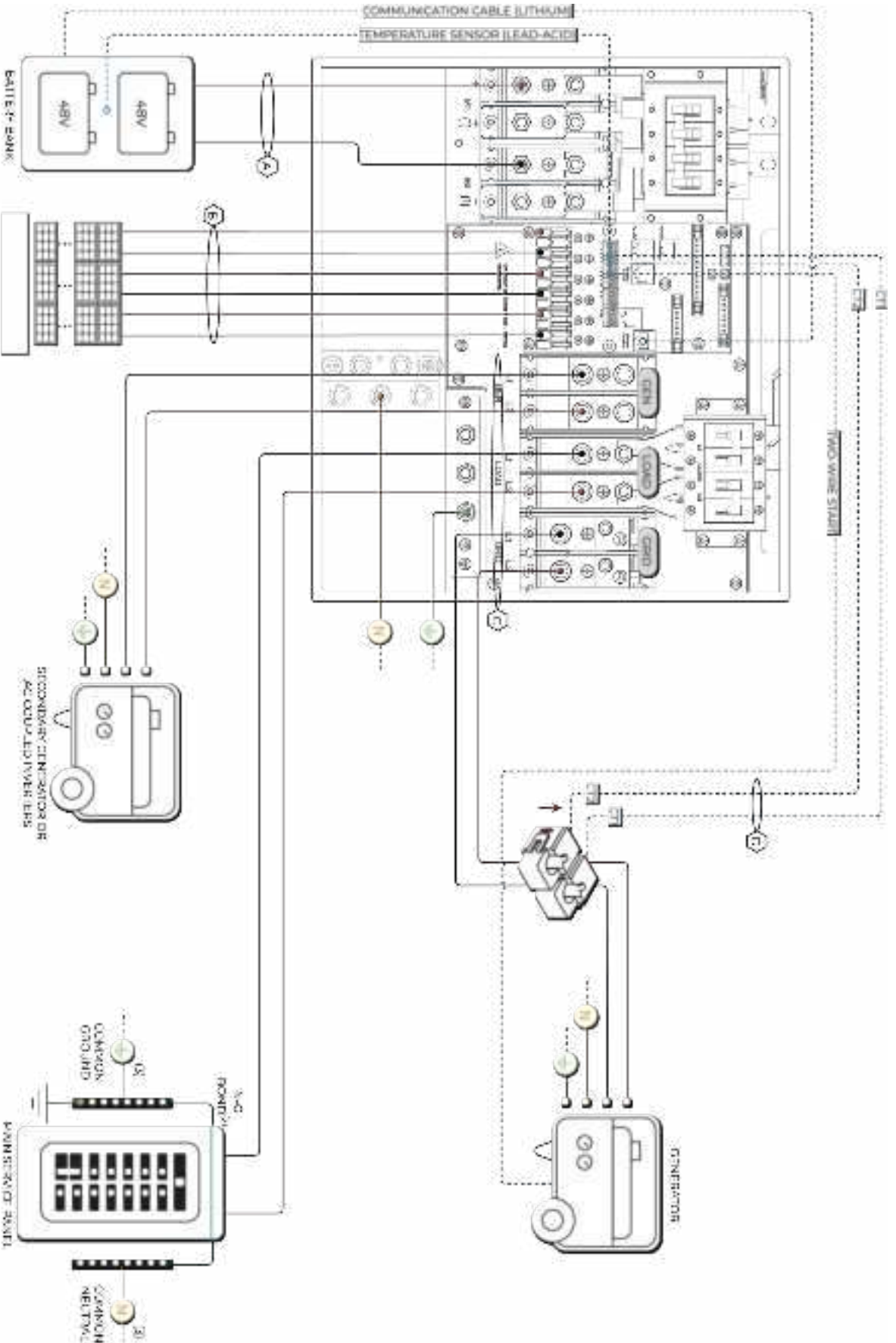

Diagram 06



# 7.8 Standard Wiring Diagram - 2 Parallel Inverters | 120/240V

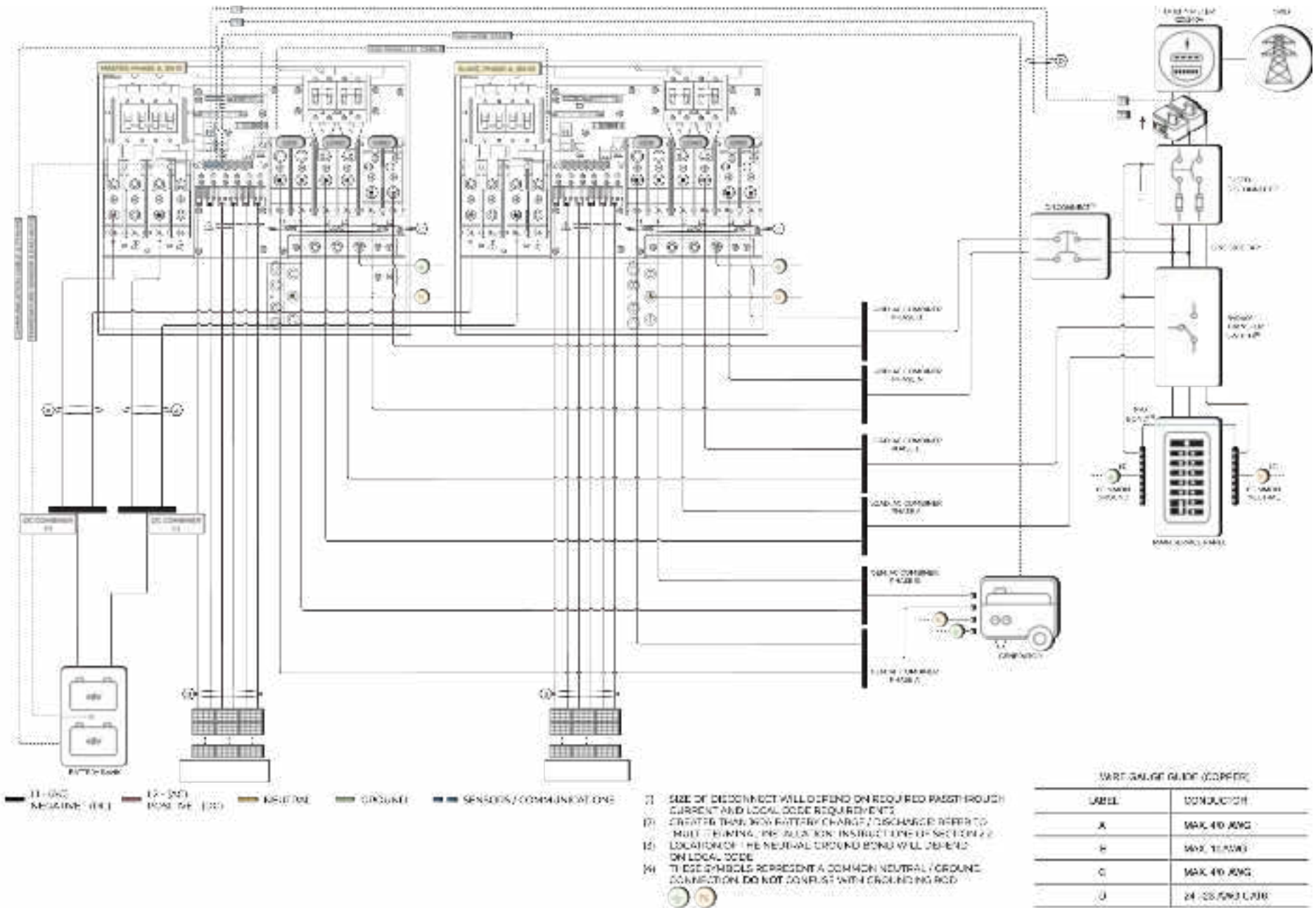

Diagram 08

Before powering up Parallel System installs, see section 5 "Parallel Systems"

# 7.9 Standard Wiring Diagram - 3 Parallel Inverters | 120/240V

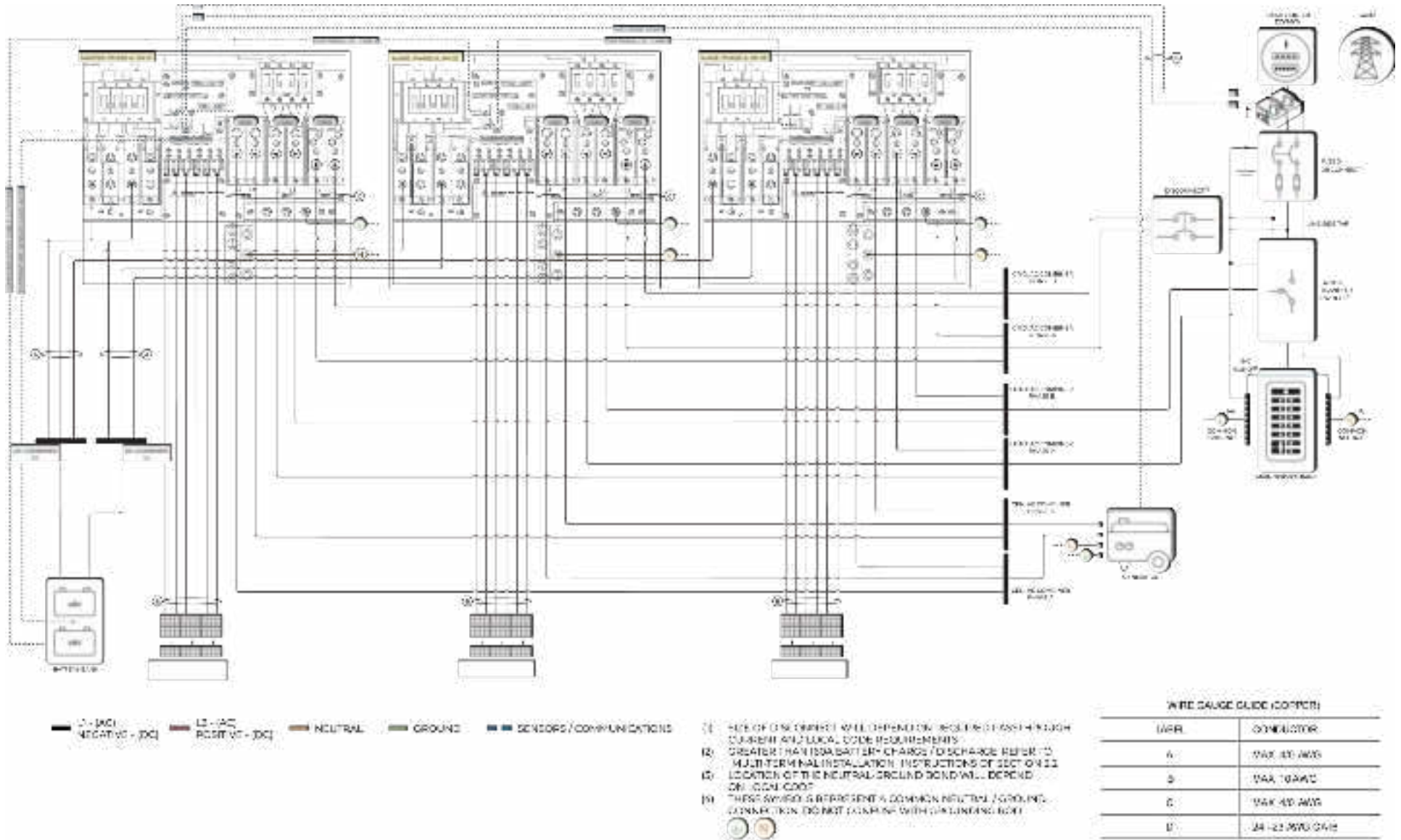

Diagram 09

Before powering up Parallel System installs, see section 5, "Parallel Systems"

# 7.10 Standard Wiring Diagram - 2 Parallel Inverters | 120/208V Unbalanced 3-Phase

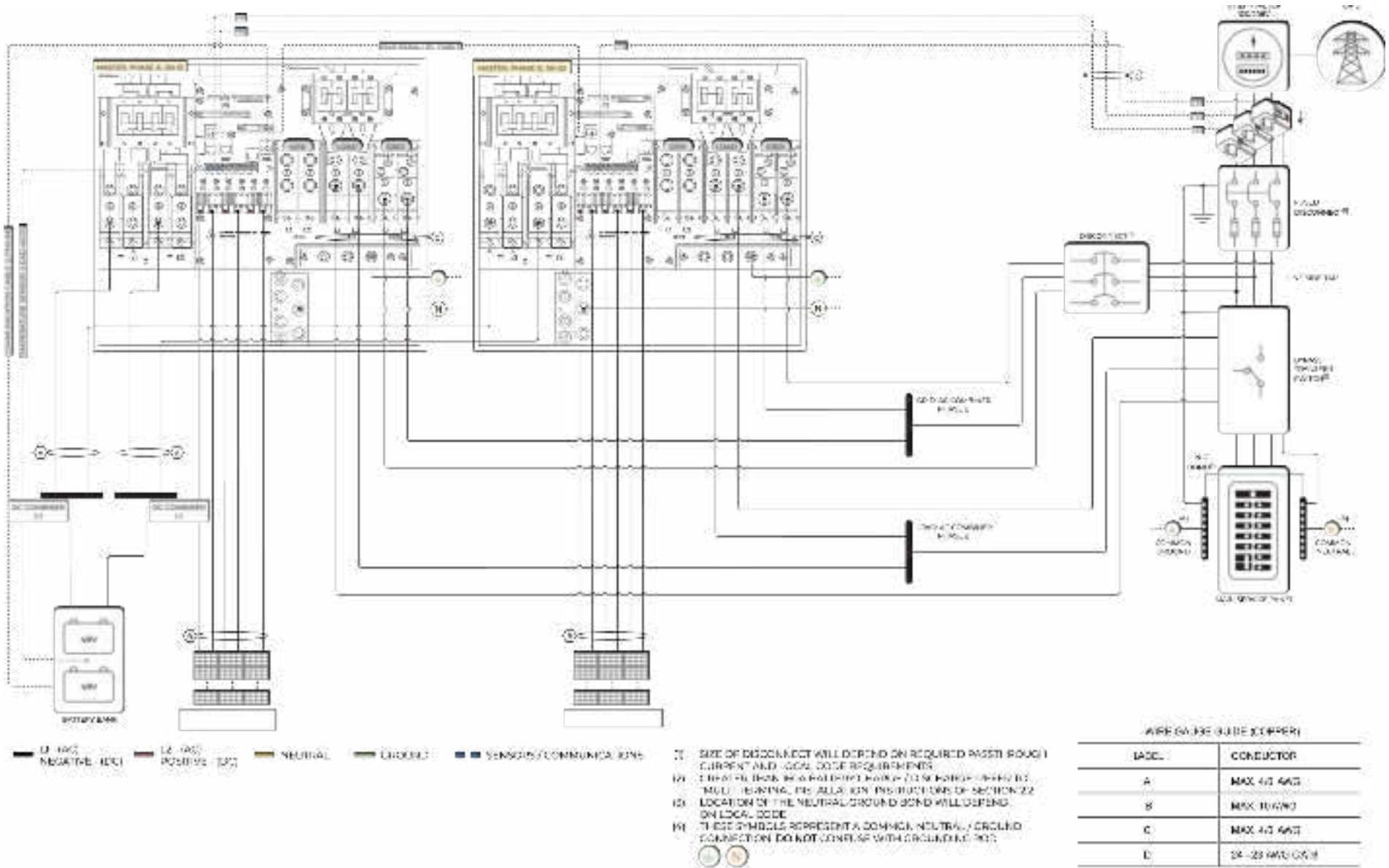

Diagram 10

Before powering up Parallel System installs, see section 5, "Parallel Systems"

# 7.11 Standard Wiring Diagram - 3 Parallel Inverters 120/208V

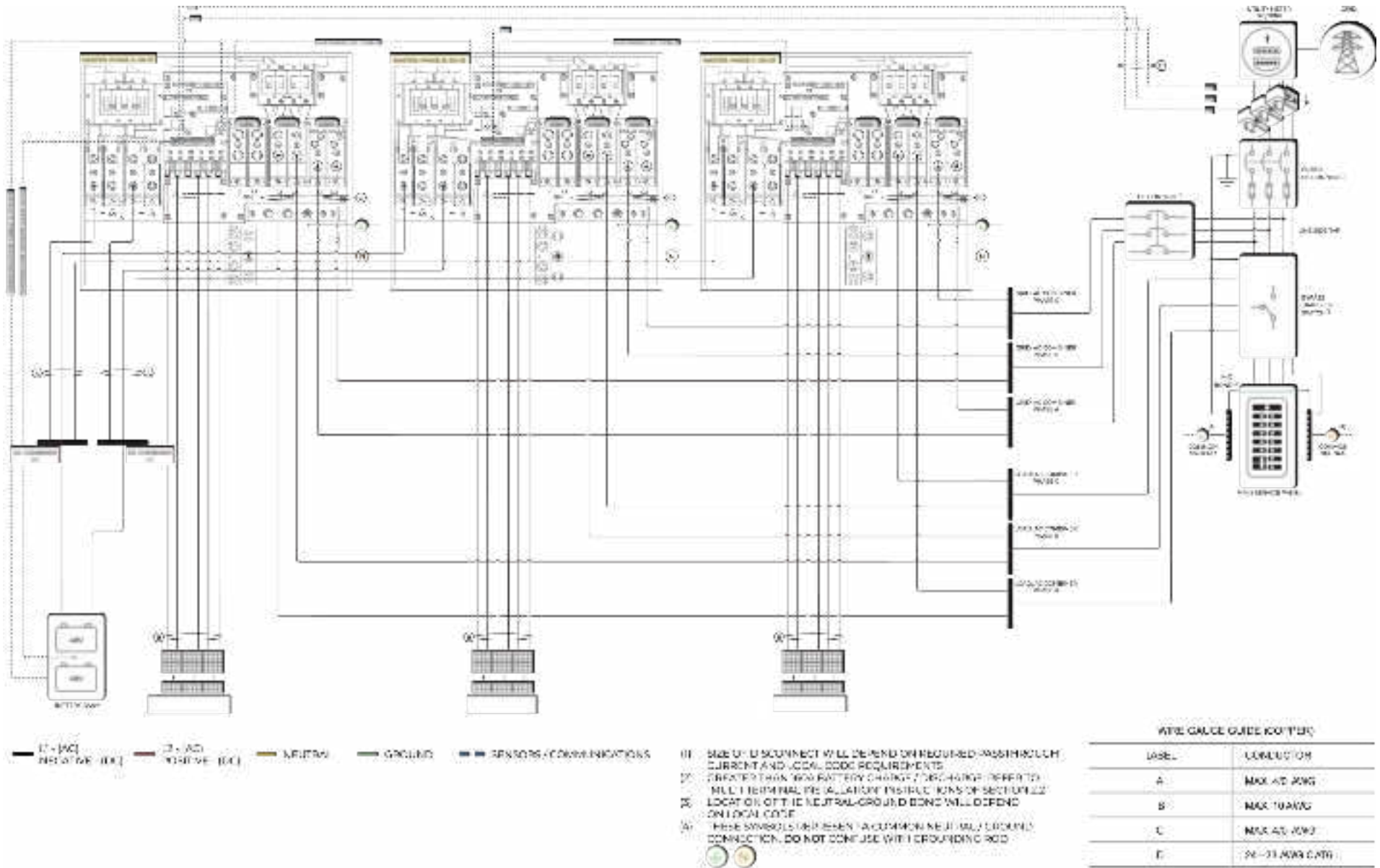

Diagram 11

Before powering up Parallel System installs, see section 5, "Parallel Systems"

## 8. Troubleshooting Guide

### LCD is not powering on

- Check all connections - at least one of the following power sources is required: PV/Grid/Battery
- Try pressing the power button, touchscreen, or navigation buttons

### Panels are connected, but DC LED indicator is not on

- Minimum starting voltage is 125V. Voltage must be above 125V and below 500V
- Wrong polarity. Check string polarity on MPPT
- PV DC disconnect is not on the ON position

### Panels are not producing

- Check for proper wiring on all solar panel connections
- Turn PV disconnect ON
- Check that the PV input voltage is not greater than 500V
- If the system measures 0V even when PV DC disconnect is ON, polarity might be wrong. Check PV polarity

### Panels are not producing much power

- PV Wire Strip Length: 5/8". Your batteries are charged and is limited to house loads; you can test Grid Sell to verify.

### The system does not keep batteries charged

- Verify there is proper communication between the Sol-Ark and the battery:  > **Li-Batt Info**
- Verify proper Charge and Voltage settings according to battery manufacturer and battery bank arrangement

### Auto Gen-Start is not working

- Make sure the generator has a compatible Two-Wire
- Verify adequate connection to the Sol-Ark auto-start input pins

### Normal LED indicator is not on

- Sol-Ark is in pass-through-only mode, only a Grid connection
- Not fully energized (DC Solar panels AND Grid or just batteries)
- In alarm state
- Sol-Ark is not working correctly. Call Sol-Ark Technical Support at +1 (972) 575-8875 ext. 2

### The Alarm LED indicator is on

- Check the system alarms menu to identify the alarm

### Grid HM value is negative when it should be positive (only applies in Limited to Home mode)

- Limiter Sensors are backwards, L1/L2 sensors are swapped, or incorrectly wired.
- Execute the **Auto Learn Home Limit Sensors** command shown in "2.9 Limit Sensors (CT sensors)" on page 23.

### AC Overload Fault or Bus Unbalance Fault

- Check Transfer Switch/Subpanel wiring
- Check for large loads that consume more than the inverter rating

### The system connects to grid and quickly disconnects

- Verify Neutral wire connection (0Vac referenced to GND)
- Check the programmed frequency, and verify the Sol-Ark measures 120V between L and N
- If the system is overloading, verify that proper phase sequence between **GRID** and **LOAD** terminals

### DC Overload Fault

- Check PV voltage. Ensure no more than 500V
- Make sure you have not wired more than 2 solar strings in parallel per MPPT

### System is beeping

- Check the System Alarms menu to see which alarm has been triggered. Most alarms will self-reset
- Do a Power Cycle as shown in "in "2.12 Power Cycle Sequence" on page 29.

### Battery cable sparks when connected

- If applicable, flip the built-in breakers of the battery bank before connecting or disconnecting batteries

### Battery symbol on the home screen is red

- The battery is below the empty voltage
- Battery is over-voltage

### Battery symbol on the home screen is yellow

- The battery is low, or the charge/discharge current is close to the programmed limit

### Grid symbol on the home screen is yellow

- Grid parameters are out of specified operating range
- There is a grid outage and there is no voltage on the **GRID** terminal
- System is Off-Grid

### System has restarted

- Occurs when the system has overloaded, battery voltage has surpassed 63V
- There was a software update

### Batteries were connected backwards

- ⚠ System will be damaged, and warranty will be lost

### Why is the LCD screen still on when the power button is off?

- This happens when the power button is in the "OFF" position
- This happens when the system is not fully energized: PV or Grid only

### The Batt SOC% is not reaching 100%

- The Sol-Ark might be in the calibration phase and estimating the battery SOC. We suggest waiting three full days to let the unit go through the 4-stage charging curve to converge to an accurate percentage
- If the suggestion above does not work, you can re-adjust the battery capacity under **Battery Setup > Batt Capacity** to restart the calibration process

### Generator setup is reading 0Hz

- Generator is operating at a frequency outside the permissible range. Select **General Standard** grid mode. Widen the frequency range to 55Hz-65Hz as shown in "2.5 Integrating a Generator" on page 16.

### Color Touchscreen is Frozen

- Press and hold the Escape button (◀) for 7-10 seconds.
- If the **Escape** button doesn't work, do a power cycle sequence as shown in "2.12 Power Cycle Sequence" on page 30.

### Grid Phase Wrong

- ⚠ If the Sol-Ark screen shows a "Grid Phase Wrong" message, it means there is a phasing issue in the wiring. If left unchecked, it may cause overload faults and **DAMAGE**. See "5.3 Three-Phase Systems" on page 55.

## 8.1 Sol-Ark Error codes

| Fault | Instruction                | Common Cause/Remedy  |
|-------|----------------------------|--|
| F1    | DC_Inversed_Failure        | If you have parallel systems and turn one system off, you will get this notification. <b>NOT</b> a fault.  |
| F8    | GFDI_Relay_Failure         | Check for continuity on the inverter's neutral and ground. Ensure there is only ONE neutral-to-ground bond in the system. Current Leakage from inverter AC output to Ground, check Ground and neutral are connected at the main panel. |
| F13   | Grid_Mode_change           | This happens when not using batteries or if Grid Input settings are changed. This is a notification, <b>NOT</b> a fault. If you switch from No Batt to Battery mode, power down completely to restart.                                 |
| F15   | AC_OverCurr_Failure        | It is usually caused by Loads too large for the inverter. If Off-Grid, the battery discharge Amps are programmed too low. Overloads can result in F15, F18, F20, or F26.   |
| F16   | GFCI_Failure               | Ground fault. Check PV+ or PV- wiring (which must be ungrounded). Exposed PV conductors + rain can also cause. Check that the neutral line and Ground are not double-bonded (common with portable generators).                         |
| F18   | Tz_AC_OverCurr_Fault       | Overloaded the Load Output (reduce loads) or overloaded a generator (reduce Gen Start A). Wiring Short on AC Side can also cause this error. Overloads can result in F15, F18, F20, or F26.  |
| F20   | Tz_Dc_OverCurr_Fault       | It is typically caused by DC current from the battery that is too large (ex: 4 Ton AC Unit) or too much PV current (3 or more strings in parallel). Overloads can result in F15, F18, F20, or F26.                                     |
| F22   | Tz_EmergStop_Fault         | Initiated Emergency Stop; see sensor pinout table.   |
| F24   | DC_Insulation_Fault        | An exposed PV conductor combined with moisture is faulting (can cause F16, F24, and F26).  |
| F25   | DC_Feedback_Fault          | No battery connection to the Inverter and Activate Battery is enabled. Disable Activate Battery in settings while no battery is connected.   |
| F26   | BusUnbalance_Fault         | Too much load on one leg (L1 or L2) vs. the other leg or DC loads on the AC output when Off-Grid. Grounded PV+/- wire can cause F20, F23, or F26.  |
| F29   | Parallel_CANBus_Fault      | Usually, a communication error for parallel systems. Check cables, and MODBUS addresses.   |
| F31   | Soft_Start_Failed          | Soft Start of the large motor failed.  |
| F34   | AC_Overload_Fault          | AC Overload or load shorted. Reduce heavy loads.   |
| F35   | AC_NoUtility_Fault         | Grid connection lost.  |
| F37   | DCLLC_Soft_Over_Cur        | Software DC overcurrent.   |
| F39   | DCLLC_Over_Current         | Hardware DC overcurrent.   |
| F40   | Batt_Over_Current          | Batteries exceeded their current discharge limit.  |
| F41   | Parallel_System_Stop_Fault | If one system faults in parallel, this normal fault will register on the other units as they disconnect from the grid.   |
| F45   | AC_UV_OverVolt_Fault       | Grid under voltage causes a disconnect. This will self-reset when the grid stabilizes.   |
| F46   | Battery_Backup_Fault       | Cannot communicate with other parallel systems. Check "Master" = 1, "Slaves" = 2-9, and that ethernet is connected.  |
| F47   | AC_OverFreq_Fault          | Grid over Frequency (common in power outages) causes a disconnect. Will self-reset when grid stabilizes.   |
| F48   | AC_UnderFreq_Fault         | Grid under Frequency (common in power outages) causes a disconnect. Will self-reset when grid stabilizes.  |
| F55   | DC_VoltHigh_Fault          | PV may be higher than 500V. Battery voltage should not be above 59V or 63V (depending on model).   |
| F56   | DC_VoltLow_Fault           | Batteries are overly discharged, the inverter is Off-Grid and exceeded the programmed batt discharge current by 20%, or Lithium BMS has shut down. If battery settings are incorrect, this can also happen.                            |
| F58   | BMS_Communication Fault    | Sol-Ark is programmed to BMS Lithium Battery Mode but cannot communicate with a BMS. BMS_Err_Stop is enabled, but cannot communicate with a battery BMS  |
| F60   | Gen_Volt_or_Fre_Fault      | Generator Voltage or Frequency went outside the allowable range.   |
| F61   | Button_Manual_OFF          | The parallel "Slave" system turned off without turning off the "Master."   |
| F63   | Arc_Fault                  | Can be a poor PV connector/connection, or a false alarm due to powerful lightning storms.  |
| F64   | Heatsink_HighTemp_Fault    | Check that the built-in fans are running; the ambient temperature may be too high. Make sure there's proper clearance.   |

# 9. Warranty Verification Checklist

**AFTER** the system is operational, please register your product by filling out this verification checklist and sending it to Sol-Ark. Go to <https://www.sol-ark.com/register-your-sol-ark/> to register.



Installer/Company: \_\_\_\_\_ Date: (YYYY-MM-DD)

Inverter SN: \_\_\_\_\_ Gateway SN: \_\_\_\_\_

Mark  for all that apply

Indicate the type of system (all that apply):

- Grid-Tied only     
  Grid-Tied with battery backup     
  Off-Grid     
  Parallel system: # \_\_\_\_\_ inverters

Indicate integrated components (all that apply):

|   |   |  |  |
|---|---|--|--|
| <input type="checkbox"/> Utility grid                 | <input type="checkbox"/> DC solar panels              | <input type="checkbox"/> AC coupled solar panels     | <input type="checkbox"/> Generator         |
| <input type="checkbox"/> LOAD installed service panel | <input type="checkbox"/> GRID installed service panel | <input type="checkbox"/> GEN installed service panel | <input type="checkbox"/> Lithium batteries |
| <input type="checkbox"/> Lead-Acid batteries          | <input type="checkbox"/> Wind Turbine                 |  |  |

**⚠** It is strongly recommended to send a **Wiring Diagram** of the installation to [support@sol-ark.com](mailto:support@sol-ark.com) for verification, otherwise Sol-Ark expressly disclaims any responsibility for performance issues arising from improper installation. Installers and users are solely responsible for following proper installation procedures outlined in provided documentation. Sol-Ark disclaims any liability for changes in the installation that might result in electrical malfunctions or any other issues related to the Sol-Ark product.

**!** Circle **N/A (Not Applicable)** if the verification step is not relevant to the type of system or does not apply to the integrated components.

|  |   |
|--|---|
| A wiring diagram of the installation was sent to Sol-Ark for verification  | <input type="checkbox"/> Y <input type="checkbox"/> N |
| Setup for remote system monitoring through Wi-Fi / Ethernet is completed. Gateway SN: _____  | <input type="checkbox"/> Y <input type="checkbox"/> N |
| The inverter is installed in a location where the LCD screen is always protected from direct sunlight  | <input type="checkbox"/>                              |
| The inverter has the minimum specified vertical and lateral clearance for proper heat dissipation  | <input type="checkbox"/>                              |
| The maximum DC input voltage does not surpass 500V <sub>DC</sub>   | <input type="checkbox"/>                              |
| The battery bank does not surpass 63V <sub>DC</sub>  | <input type="checkbox"/>                              |
| All battery conductors are properly connected and secured to the (+, -) terminals of the inverter  | <input type="checkbox"/> N/A                          |
| Battery communication was successfully established   | <input type="checkbox"/> N/A                          |
| All Battery Setup parameters are programmed according to battery manufacturer specifications   | <input type="checkbox"/> N/A                          |
| The Sol-Ark properly generates power from the solar panels to charge the batteries   | <input type="checkbox"/> N/A                          |
| Grid / Generator is properly connected to the Sol-Ark and the phase sequence was verified  | <input type="checkbox"/> N/A                          |
| " <input checked="" type="checkbox"/> Grid / Gen Charge" settings are programmed correctly. Grid / Generator adequately charge the batteries     | <input type="checkbox"/> N/A                          |
| For Off-Grid systems: The mode "General Standard" is programmed and the V & f ranges are increased   | <input type="checkbox"/> N/A                          |
| When " <input checked="" type="checkbox"/> Grid Sell" is enabled, the Sol-Ark sells power back to the grid (negative HM measurements for L1, L2) | <input type="checkbox"/> N/A                          |
| Limit sensors are correctly installed on Grid lines / Generator lines  | <input type="checkbox"/> N/A                          |
| Only when " <input checked="" type="checkbox"/> Limited Power to Home" is enabled, the Sol-Ark matches total load demand (Meter Zero)            | <input type="checkbox"/> N/A                          |
| Disconnect the grid: during Off-Grid operation, the inverter properly supplies <b>LOAD</b> demand for PV and batteries                           | <input type="checkbox"/> N/A                          |
| Disconnect the grid AND solar panels: during Off-Grid operation, the inverter properly draws power from batteries                                | <input type="checkbox"/> N/A                          |

\_\_\_\_\_  
Installer name and signature

\_\_\_\_\_  
Customer name and signature

\_\_\_\_\_  
Date



## Basic Setup

**Basic Setup**

Display | Time | **Advanced** | Factory Reset | Parallel

Brightness

Beep

Auto Dim  6005

CANCEL OK

**Basic Setup**

Display | Time | **Advanced** | Factory Reset | Parallel

Year Month Day

AM/PM 2021 10 26

Hour Minute Second

Time Sync 03 04 15

Season1 Season2 Season3

Seasons 1 - 1 4 - 1 8 - 1

CANCEL OK 4 - 1 8 - 1 12 - 1

**Basic Setup**

Display | Time | **Advanced** | Factory Reset | Parallel

Solar Arc Fault ON  Clear Arc Fault

Gen peak-shaving

Grid peak-shaving 8000W

Auto detect Home Link Sensors

ARC parameters:  
 030000  
 040000  
 000000  
 000000  
 000000  
 040000  
 000100  
 238094

CT ratio: 2000

UPS Time: 0ms

CANCEL OK

**Basic Setup**

Display | Time | **Advanced** | Factory Reset | Parallel

Parallel  Master  Slave

Modbus ID: 00

Phase A  Phase B  Phase C

Meter → Grid  Meter → Grid Tie  Meter → Load

Meter Select: No Meter

CANCEL OK

# Batt Setup

**Batt Setup**

Batt | Charge | Discharge | Smart Load

Batt Capacity: 400Ah  Use Batt V Charged

Max A Charge: 275A  Use Batt % Charged

Max A Discharge: 275A  No Battery

TEMPCO: -0mV/C/Cell  BMS Lithium Batt

Activate Battery

CANCEL OK

**Batt Setup**

Batt | Charge | Discharge | Smart Load | Wind Turbine

StartV: 49.0V 49.0V Float V: 55.9V

Start%: 60% 80% Absorbition V: 55.9V 1h 00m 0%

A: 10A 252A Equalization V: 55.9V

Gen Charge  Grid Charge 30 Days 1.0 hours

Generated Economic Cycle (Day & Time): Mon 08:00 4 min

Gen Force 1440min  Gen max run time CANCEL OK

**Batt Setup**

Batt | Charge | Discharge | Smart Load

Weakness: 46.0V 20% Batt Resistance: 4mOhms

Low Batt: 47.5V 35% Batt Charge Efficiency: 99.0%

Percent: 52.0V 50%

Batt Empty V: 47.0V  BMS for 30s

CANCEL OK

**Batt Setup**

Batt | Charge | Discharge | Smart Load | Wind Turbine

Use gen input as load output  For AC Coupled load to Gen

On Grid always on High Pri: 5000%

Smart Load OFF Batt: 51.0V 80%  AC couple on grid side

Smart Load ON Batt: 54.0V 80%  AC couple on load side

Solar Power(W): 100W CANCEL OK

**Batt Setup**

Batt | Charge | Discharge | Smart Load | Wind Turbine

DC1 for WindTurbine  DC2 for WindTurbine

|    |      |      |     |      |       |
|----|------|------|-----|------|-------|
| V1 | 90V  | 0.0A | V7  | 90V  | 0.0A  |
| V2 | 110V | 1.0A | V8  | 110V | 10.0A |
| V3 | 130V | 2.0A | V9  | 130V | 20.0A |
| V4 | 150V | 4.0A | V10 | 150V | 18.0A |
| V5 | 170V | 6.0A | V11 | 170V | 15.0A |
| V6 | 190V | 7.5A | V12 | 190V | 16.0A |

OK CANCEL

# Limiter

**Limiter Params**  
 Limiter: Other

|   | Time  | Power | Rate | Chac | Set | Week |
|---|-------|-------|------|------|-----|------|
| Grid Sell   | 18:00 | 2000  | 50%  |      |     |      |
| Limited Power to Home                                     | 05:00 | 2000  | 50%  |      |     |      |
| <input checked="" type="checkbox"/> Limited Power to Load | 09:00 | 2000  | 100% |      |     |      |
|   | 13:00 | 2000  | 100% |      |     |      |
| Time of Use Setup   | 17:00 | 2000  | 50%  |      |     |      |
|   | 21:00 | 2000  | 50%  |      |     |      |

Cancel OK

**Time of Use Setup**

Mon  Tue  Wed  Thu

Fri  Sat  Sun

Section 1  Section 2  Section 3

CANCEL OK

**Grid Params**  
 Limiter: Other

GBI connected to Grid Input

Zero Export Power

Bat Dis  Load Shed

CANCEL OK

# Grid Setup

**Grid Param**

Grid Selection | Connect | IP | F(W) | V(W)/V(Q) | P(Q)/P(F)

Grid Mode:  S/S

Grid Frequency:  60Hz  49Hz

Single Phase

120/240V Split Phase

120/240V 3 Phase

Grid Reconnect Time: 300s

Power Factor: 1.000

Fuse ID: 0%

Q Response: 100

Output V: 120/240V

Output In: +0%

**Grid Param**

Grid Selection | Connect | IP | F(W) | V(W)/V(Q) | P(Q)/P(F)

Reconnect

Grid Vol High: 238.0V

Grid Vol Low: 181.2V

Grid Hz High: 61.5Hz

Grid Hz Low: 58.5Hz

Reconnect Ramp rate: 6%

Reconnect

Grid Vol High: 249.0V

Grid Vol Low: 194.0V

Grid Hz High: 63.0Hz

Grid Hz Low: 57.0Hz

Reconnect Ramp rate: 6%

**Grid Param**

Grid selection | Connect | IP | F(W) | V(W)/V(Q) | P(Q)/P(F)

Over voltage U< (10 min. running mean): 276.0V

|     |        |         |     |         |          |
|-----|--------|---------|-----|---------|----------|
| HV3 | 288.0V | -0.16s  | HF3 | 65.00Hz | -0.16s   |
| HV2 | 288.0V | -0.16s  | HF2 | 65.00Hz | -0.16s   |
| HV1 | 264.0V | -13.00s | HF1 | 65.00Hz | -199.00s |
| LV1 | 211.2V | 30.00s  | LF1 | 55.00Hz | 299.00s  |
| LV2 | 168.0V | 2.00s   | LF2 | 55.00Hz | -0.16s   |
| LV3 | 120.0V | -0.16s  | LF3 | 55.00Hz | -0.16s   |

**Grid Param**

Grid selection | Connect | IP | F(W) | V(W)/V(Q) | P(Q)/P(F)

Over frequency

Start freq F: 60.50Hz

Start delay: 0.00s

Drop F: 40%/Hz

Stop freq F: 63.50Hz

Stop delay: 0.00s

F(W)

Under frequency

Start freq F<: 58.50Hz

Start delay F<: 0.00s

Drop F<: 40%/Hz

Stop freq F<: 55.50Hz

Stop delay F<: 0.00s

**Grid Param**

Grid selection | Connect | IP | F(W) | V(W)/V(Q) | P(Q)/P(F)

V(W)  V(Q)

|            |          |          |           |
|------------|----------|----------|-----------|
| Response_T | P1: 100% | Low: 20% | Low: 100% |
| V1: 100%   | F1: 100% | V1: 80%  | Q1: 80%   |
| V2: 100%   | F2: 50%  | Q2: 80%  | Q2: 0%    |
| V3: 112%   | F3: 0%   | V3: 100% | Q3: 0%    |
| V4: 120%   | F4: 0%   | V4: 100% | Q4: 40%   |

**Grid Param**

Grid selection | Connect | IP | F(W) | V(W)/V(Q) | P(Q)/P(F)

P(Q)  P(F)

|          |           |          |          |          |          |
|----------|-----------|----------|----------|----------|----------|
| Low: 50% | Low: 100% | F1: 20%  | Q1: 20%  | V1: 50%  | F1: 100% |
| F2: 100% | Q2: 30%   | F2: 100% | Q2: 30%  | V2: 100% | F2: 100% |
| F3: 100% | Q3: 20%   | V3: 100% | F3: 100% | V4: 100% | F4: 100% |
| F4: 100% | Q4: 20%   | V4: 100% | F4: 100% |          |          |

