



Maintenance and Service Guide

HP OmniBook 5 14 inch Laptop Next Gen
AI PC

Model numbers: 14-hm0xxx, 14-hh0xxx

HP OmniBook 5 14 inch Laptop AI PC

Model numbers: 14-hn0xxx, 14-kf0xxx HP
OmniBook 5 Laptop PC Model number: 14-
hk0xxx

SUMMARY

This guide provides maintenance information about such topics as spare parts, removal and replacement of parts, security, and backing up.



Legal information

© Copyright 2026 HP Development Company, L.P.

AMD, Radeon, and Ryzen are trademarks of Advanced Micro Devices, Inc. ChromeOS is a trademark of Google LLC. Bluetooth is a trademark owned by its proprietor and used by HP Inc. under license. Intel, Core, and Thunderbolt are trademarks of Intel Corporation or its subsidiaries in the U.S. and/or other countries. Microsoft and Windows are either registered trademarks or trademarks of Microsoft Corporation in the United States and/or other countries. USB Type-C, and USB-C port logos are trademarks or registered trademarks of USB Implementers Forum. DisplayPort and the DisplayPort logo are trademarks owned by the Video Electronics Standards Association (VESA) in the United States and other countries. Wi-Fi is a registered trademark of Wi-Fi Alliance.

The information contained herein is subject to change without notice. The only warranties for HP products and services are set forth in the express warranty statements accompanying such products and services. Nothing herein should be construed as constituting an additional warranty. HP shall not be liable for technical or editorial errors or omissions contained herein.

First Edition: February 2026

Document Part Number: P71153-001

Product notice

This guide describes features that are common to most products. Some features might not be available on your computer.

Not all features are available in all editions or versions of Windows. Systems might require upgraded and/or separately purchased hardware, drivers, software, or BIOS update to take full advantage of Windows functionality. Windows is automatically updated, which is always enabled. High-speed internet and Microsoft account required. ISP fees might apply and additional requirements might apply over time for updates. See <http://www.windows.com>. **If your product ships with Windows in S Mode:** Windows in S Mode works exclusively with apps from the Microsoft Store within Windows. Certain default settings, features, and apps cannot be changed. Some accessories and apps that are compatible with Windows might not work (including some antivirus, PDF writers, driver utilities, and accessibility apps), and performance might vary, even if you switch out of S Mode. If you switch to Windows, you cannot switch back to S Mode. Learn more at Windows.com/SmodeFAQ.

To access the latest user guides, go to <http://www.hp.com/support>, and follow the instructions to find your product. Then select **Setup & User Guides**.

Software Terms

By installing, copying, downloading, or otherwise using any software product preinstalled on this computer, you agree to be bound by the terms of the HP End User License Agreement (EULA). If you do not accept these license terms, your sole remedy is to return the entire unused product (hardware and software) within 14 days for a full refund subject to the refund policy of your seller.

For any further information or to request a full refund of the price of the computer, please contact your seller.

Safety warning notice

Reduce the possibility of heat-related injuries or of overheating the computer by following the practices described.

 **WARNING!** To reduce the possibility of heat-related injuries or of overheating the computer, do not place the computer directly on your lap or obstruct the computer air vents. Use the computer only on a hard, flat surface. Do not allow another hard surface, such as an adjoining optional printer, or a soft surface, such as pillows, rugs or clothing, to block airflow. Also, do not allow the AC adapter to come into contact with the skin or a soft surface, such as pillows, rugs or clothing, during operation. The computer and the AC adapter provided by HP comply with the user-accessible surface temperature limits defined by applicable safety standards.

Important notice about Customer Self-Repair parts

Your computer includes Customer Self-Repair parts and parts that should be accessed only by an authorized service provider.

 **IMPORTANT:** See [Removal and replacement procedures for Customer Self-Repair parts on page 30](#) for details.

Accessing parts described in [Removal and replacement procedures for authorized service provider parts on page 41](#) can damage the computer or void your warranty.

Table of contents

1 Product description	1
2 Getting to know your computer	6
Right side	6
Left side	6
Display	7
Low blue light mode (select products only)	8
Wake-on-voice (select products only)	8
Keyboard area	9
Touchpad settings and components	9
Touchpad settings	9
Adjusting touchpad settings	9
Turning on the touchpad	9
Touchpad components	10
Lights	10
Special keys	12
Bottom	13
Labels	14
3 Illustrated parts catalog	15
Computer major components	15
Display assembly subcomponents	18
Miscellaneous parts	20
4 Removal and replacement procedures preliminary requirements	22
Tools required	22
Service considerations	22
Plastic parts	22
Cables and connectors	22
Drive handling	22
Electrostatic discharge information	23
Generating static electricity	23
Preventing electrostatic damage to equipment	24
Personal grounding methods and equipment	24
Grounding the work area	25
Recommended materials and equipment	25
Cleaning your computer	26
Enabling HP Easy Clean (select products only)	26
Removing dirt and debris from your computer	26
Cleaning your computer with a disinfectant	27
Caring for wood veneer (select products only)	28

Packaging and transporting guidelines.....	28
Accessing support information.....	28
5 Removal and replacement procedures for Customer Self-Repair parts.....	30
Component replacement procedures.....	30
Preparation for disassembly.....	30
Bottom cover.....	30
Battery.....	33
Removing and reinstalling the same battery.....	33
Installing a new battery.....	35
6 Removal and replacement procedures for authorized service provider parts.....	41
Component replacement procedures.....	41
Solid-state drive.....	41
WLAN module.....	43
Speakers.....	45
Fan.....	46
Touchpad.....	47
I/O board.....	49
OLED board.....	49
System board.....	50
Heat sink.....	54
Display assembly.....	57
Top cover with keyboard.....	66
7 Using Setup Utility (BIOS).....	68
Starting Setup Utility (BIOS).....	68
Updating Setup Utility (BIOS).....	68
Determining the BIOS version.....	68
Preparing for a BIOS update.....	69
Downloading a BIOS update.....	69
Installing a BIOS update.....	70
8 Using HP PC Hardware Diagnostics.....	71
Using HP PC Hardware Diagnostics Windows (select products only).....	71
Using an HP PC Hardware Diagnostics Windows hardware failure ID code.....	71
Accessing HP PC Hardware Diagnostics Windows.....	71
Accessing HP PC Hardware Diagnostics Windows from HP Support Assistant (select products only).....	71
Accessing HP PC Hardware Diagnostics Windows from the Start menu (select products only).....	72
Downloading HP PC Hardware Diagnostics Windows.....	72
Downloading the latest HP PC Hardware Diagnostics Windows version from HP.....	72
Downloading the HP PC Hardware Diagnostics Windows from the Microsoft Store.....	72
Downloading HP Hardware Diagnostics Windows by product name or number (select products only).....	73
Installing HP PC Hardware Diagnostics Windows.....	73
Using HP PC Hardware Diagnostics UEFI.....	73
Using an HP PC Hardware Diagnostics UEFI hardware failure ID code.....	73
Starting HP PC Hardware Diagnostics UEFI.....	73

Starting HP PC Hardware Diagnostics UEFI through HP Hotkey Support software (select products only).....	74
Downloading HP PC Hardware Diagnostics UEFI to a USB flash drive.....	74
Downloading the latest HP PC Hardware Diagnostics UEFI version.....	75
Downloading HP PC Hardware Diagnostics UEFI by product name or number (select products only).....	75
Using Remote HP PC Hardware Diagnostics UEFI settings (select products only).....	75
Downloading Remote HP PC Hardware Diagnostics UEFI.....	75
Downloading the latest Remote HP PC Hardware Diagnostics UEFI version.....	75
Downloading Remote HP PC Hardware Diagnostics UEFI by product name or number.....	76
Customizing Remote HP PC Hardware Diagnostics UEFI settings.....	76
9 Backing up, restoring, and recovering.....	77
Backing up information and creating recovery media.....	77
Using Windows tools for backing up.....	77
Using the HP Cloud Recovery Download Tool to create a recovery USB flash drive (select products only).....	77
Restoring and recovering your system.....	77
Creating a system restore	78
Restoring and recovery methods.....	78
Recovering using the HP Recovery USB flash drive.....	78
Changing the computer boot order	79
Using HP Sure Recover (select products only).....	79
10 Specifications.....	80
Computer specifications.....	80
Display specifications.....	81
Solid-state drive specifications	81
11 Power cord set requirements.....	83
Requirements for all countries.....	83
Requirements for specific countries and regions.....	83
12 Swelling or deformation of notebook battery.....	86
Swollen notebook batteries.....	86
Swollen battery is not a safety issue	86
Discontinue using a swollen battery	86
Replace a swollen battery.....	86
Minimize battery swelling.....	86
Adaptive Battery Optimizer (consumer notebooks).....	87
HP Battery Health Manager (commercial notebooks).....	87
13 Recycling.....	88
Index.....	89

1 Product description

This table provides detailed product information.

 **NOTE:** For the latest specifications related to your computer, go to <http://www.hp.com/support> and follow the instructions to find your product. Select **Specifications & Accessories**, select **Product information**, and then select the specifications link.

Table 1-1 Product components and their descriptions

Category	Description
Product name	HP OmniBook 5 14 Inch Laptop Next Gen AI PC
	Intel® model numbers: 14-hh0xxx
	Intel CTO model number: 14t-hh000
	AMD® model number: 14-hm0xxx
	AMD CTO model number: 14z-hm000
	HP OmniBook 5 14 Inch Laptop AI PC
	Intel model number: 14-kf0xxx
	Intel CTO model number: 14t-kf000
	AMD model number: 14-hn0xxx
	AMD CTO model number: 14z-hn000
	HP OmniBook 5 Laptop PC
	Intel model number: 14-hk0xxx
	Intel CTO model number: 14t-kf000
Processors	Intel processors
	Intel Core™ Ultra 9 386H
	Intel Core Ultra 5 338H
	Intel Core Ultra 7 355
	Intel Core Ultra 5 322
	Intel Core 7 150U
	Intel Core 5 120U
	AMD processors
	AMD Ryzen™ AI 9 465
	AMD Ryzen AI 7 450
	AMD Ryzen AI 5 435
	AMD Ryzen AI 5 330
	AMD Ryzen 7-250

Table 1-1 Product components and their descriptions (continued)

Category	Description
	AMD Ryzen 5-230
Graphics	Intel graphics
	Intel Graphics
	Supports HD decode, DX12, and HDMI
	AMD graphics
	AMD Radeon™ 820M
	AMD Radeon 780M
	AMD Radeon 760M
Display	14.0 in (35.6 cm), touch screen
	2.8K (2880 × 1800), OLED + low blue light, UWVA, BrightView, DCI-P3 100%, eDP 1.5, 500 nits, 120 Hz (VRR)
	WUXGA (1920 × 1200) OLED + low blue light, UWVA, BrightView, DCI-P3 100%, eDP 1.2 without PSR, 300 nits, 60 Hz
	WUXGA (1920 × 1200) OLED + low blue light, UWVA, BrightView, DCI-P3 100%, eDP 1.2 without PSR, 300 nits, 60 Hz, DBTS
	<ul style="list-style-type: none"> • Panel certification (TUV + low blue light hardware solution + HP Eye Ease) • Microsoft HDR streaming capable • Gorilla Glass • Flicker free • Panel certification (VESA True Black HDR 1000; TUV + low blue light hardware solution + HP Eye Ease) (select products only) • HP Eye Ease
Memory	Memory is onboard, not accessible or upgradeable
	Supports LPDDR5X-7500 memory in the following configurations (AMD models):
	<ul style="list-style-type: none"> • 32 GB • 32 GB (People's Republic of China [PRC]) • 16 GB • 16 GB (PRC)
	Supports LPDDR5X-7467 memory in the following configurations (Intel models):
	<ul style="list-style-type: none"> • 32 GB • 32 GB (PRC) • 16 GB • 16 GB (PRC)

Table 1-1 Product components and their descriptions (continued)

Category	Description
	Supports LPDDR5X-6800 memory in the following configurations (Intel models): <ul style="list-style-type: none"> • 32 GB • 32 GB (PRC) • 16 GB • 16 GB (PRC)
	Supports LPDDR5X-5200 memory in the following configurations (Intel models): <ul style="list-style-type: none"> • 16 GB • 16 GB (PRC)
Primary storage	PCIe, Non-Volatile Memory express (NVMe), M.2 2280 solid-state drives (SSDs)
	1 TB, Gen5 (Intel only)
	1 TB, Gen5 (PRC) (Intel only)
	1 TB, Gen4
	1 TB, Gen4 (PRC)
	512 GB, Gen5 (Intel only)
	512 GB, Gen5 (PRC) (Intel only)
	512 GB, Gen4
	512 GB, Gen4 (PRC)
	256 GB, Gen4
	256 GB, Gen4 (PRC)
Audio and video	Dual speakers
	Supports DTS:X Ultra
	Supports HP Audio Boost
Video	HP TrueVision FHD camera: USB 2.0, indicator LED, 1 × infrared (IR) LED, f2.0, FHD BSI sensor, WDR/TNR/HDR, 80° NFOV
	Dual-array digital microphone with appropriate software: beam forming, echo cancellation, noise suppression
	1080p by 30 frames per second
	Supports Windows® Hello
Wireless	Integrated wireless module (M.2 2230 with dual antennas)
	Realtek Wi-Fi® 7 RTL8922AE-VS + Bluetooth® 6.0 (802.11be 2 × 2)
	Realtek Wi-Fi 6 RTL8852BE-VT + Bluetooth 5.4 (802.11ax 2 × 2) (Intel models)
	Intel Wi-Fi 7 R2 BE211 + Bluetooth 6.0 (802.11be 2 × 2) (Intel models)
	MediaTek Wi-Fi 6 MT7920 + Bluetooth 5.4 (802.11ax 2 × 2) (AMD models)
	<ul style="list-style-type: none"> • Bluetooth LE Audio • UNII-4 5 GHz channel

Table 1-1 Product components and their descriptions (continued)

Category	Description
	<ul style="list-style-type: none"> • Wi-Fi BIOS SAR
	<ul style="list-style-type: none"> • Dynamic Antenna Gain (Wi-Fi)
	<ul style="list-style-type: none"> • Bluetooth Audio Offload
Ports	<p>Audio-out (headphone)/audio-in (microphone) combo jack</p> <p>USB-C® 3.2 Gen 2 Thunderbolt™ 4 (2) (select products):</p> <ul style="list-style-type: none"> • Data transfer • Power delivery 3.0 • HP Sleep & Charge • DisplayPort™ 2.1 out up to 1 × 8K @ 60 Hz, 2 × 4K @ 120 Hz • HDMI 2.1b out up to 8K @ 60 Hz with HDCP 2.3 out through adapter <p>USB-C 3.2 Gen 2 (2) (select products):</p> <ul style="list-style-type: none"> • Data transfer • Power delivery • HP Sleep & Charge • DisplayPort 1.4 out up to 4K @ 60 Hz • HDMI 2.1 out up to 4K @ 60 Hz through adapter
Keyboard/pointing devices	<p>Keyboard</p> <p>Backlit</p> <p>Supports power button key</p> <p>Touchpad requirements</p> <p>Clickpad with image sensor</p> <p>Multitouch gestures enabled</p> <p>Precision touchpad</p> <p>Haptics touchpad supporting gestures</p>
Power requirements	<p>Battery (HP Long Life, polymer)</p> <p>3 cell, 59 Wh</p> <p>HP Fast Charge Technology</p> <p>Smart AC adapters (USB-C) (select products only)</p> <p>65 W, GaN, standard, straight</p> <p>65 W, GaN, wall mount, halogen free, foldable</p> <p>65 W, GaN, wall mount, halogen free, fixed</p> <p>Power cord (select products only)</p> <p>C5, conventional, 1 m (3.3 ft), sticker</p>

Table 1-1 Product components and their descriptions (continued)

Category	Description
	Non-standard, black, straight, halogen free, duckhead only
Security	Supports firmware-based Trusted Platform Module (TPM) 2.0
	Microphone mute
	Camera privacy cover
Operating system	Windows 11 Home 64 Copilot+ Premium
	Windows 11 Home 64 Copilot+ Premium Chinese Market CPPP
	Windows 11 Home 64 Copilot+ Premium Single Language Africa Market PPP
	Windows 11 Home 64 Copilot+ Premium Single Language APAC EM PPP
	Windows 11 Home 64 Copilot+ Premium Single Language India Market PPP
	Windows 11 Home 64 Copilot+ Premium Single Language Indonesia Market PPP
	Windows 11 Home 64 Copilot+ Standard
	Windows 11 Home 64 Copilot+ Standard Chinese Market CPPP
	Windows 11 Home 64 Copilot+ Standard Single Language Africa Market PPP
	Windows 11 Home 64 Copilot+ Standard Single Language APAC EM PPP
	Windows 11 Home 64 Copilot+ Standard Single Language India Market PPP
	Windows 11 Home 64 Copilot+ Standard Single Language Indonesia Market PPP
	Windows 11 Home 64 High-end Chinese Market CPPP
	Windows 11 Home 64 Plus
	Windows 11 Home 64 Plus Single Language
	Windows 11 Home 64 Plus Single Language Africa Market PPP
	Windows 11 Home 64 Plus Single Language APAC EM PPP
	Windows 11 Home 64 Plus Single Language India Market PPP
	Windows 11 Home 64 Plus Single Language Indonesia Market PPP
	Windows 11 Pro 64 Copilot+ Premium
	Windows 11 Pro 64 Copilot+ Standard
	FreeDOS 3.0
Serviceability	End user replaceable parts
	AC adapter
	Bottom cover
	Battery

2 Getting to know your computer



Your computer features top-rated components. This chapter provides details about your components, where they are located, and how they work.

Right side

Use this illustration and table to identify the components on the right side of the computer.

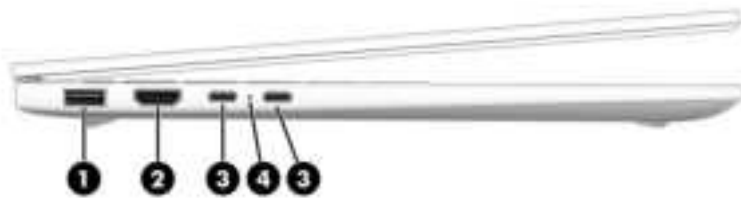

Table 2-1 Right-side components and their descriptions

	Component	Description
(1)	 Audio-out (headphone)/Audio-in (microphone) combo jack	<p>Connects optional powered stereo speakers, headphones, earbuds, a headset, or a television audio cable. Also connects an optional headset microphone. This jack does not support optional standalone microphones.</p> <p>WARNING! To reduce the risk of personal injury, adjust the volume before putting on headphones, earbuds, or a headset. For additional safety information, see the <i>Regulatory, Safety, and Environmental Notices</i>.</p> <p>To access this guide:</p> <ul style="list-style-type: none">■ Select the Search icon in the taskbar, type HP Documentation in the search box, and then select HP Documentation. <p>NOTE: When a device is connected to the jack, the computer speakers are disabled.</p>
(2)	 USB port	<p>Connects a USB device, provides high-speed data transfer, and (for select products) charges small devices (such as a smartphone) when the computer is on or in sleep mode.</p>



Left side

Use this illustration and table to identify the components on the left side of the computer.



NOTE: Image shown may vary from actual product image.

Table 2-2 Left-side components and their descriptions

	Component	Description
(1)	 USB port	Connects a USB device, provides high-speed data transfer, and (for select products) charges small devices (such as a smartphone) when the computer is on or in sleep mode.
(2)	 HDMI port	Connects an optional video or audio device, such as a high-definition television, any compatible digital or audio component, or a high-speed High-Definition Multimedia Interface (HDMI) device.
(3)	 USB Type-C® ports (2)	<p>Connect a USB device, provide data transfer, and charge small devices (such as a smartphone), even when the computer is off.</p> <p>NOTE: Use a standard USB Type-C charging cable or cable adapter (purchased separately) when charging a small external device.</p> <p>- and -</p> <p>Connect a display device that has a USB Type-C connector, providing DisplayPort output .</p>
(4)	AC adapter and battery light	<ul style="list-style-type: none"> ● White: The AC adapter is connected and the battery is fully charged. ● Blinking amber: The AC adapter is disconnected and the battery has reached a low battery level. ● Amber: The AC adapter is connected and the battery is charging. ● Off: The battery is not charging.

Display

The computer display can include essential components such as speakers, antennas, cameras, and microphones.

Low blue light mode (select products only)

Your computer display is shipped from the factory in low blue light mode for improved eye comfort and safety. Also, blue light mode automatically adjusts blue light emissions when you are using the computer at night or for reading.

WARNING! To reduce the risk of serious injury, read the *Safety & Comfort Guide*. It describes proper workstation setup and proper posture, health, and work habits for computer users. The *Safety & Comfort Guide* also provides important electrical and mechanical safety information. The *Safety & Comfort Guide* is available on the web at <http://www.hp.com/ergo>.

Wake-on-voice (select products only)

Use the wake-on-voice feature to wake or interact with your computer quickly.

To access the wake-on-voice settings, follow these steps:

1. Select the **Search** icon in the taskbar, type `Xiaowei` in the search box, and then select **Xiaowei**.
2. When the tool opens, use your mobile device to scan the QR code, which takes you to the settings page, where you can select your wake-on-voice features.
3. Follow the on-screen instructions.

NOTE: Allow the Xiaowei app to continue running on the computer.

Use this illustration and table to identify components on the display.

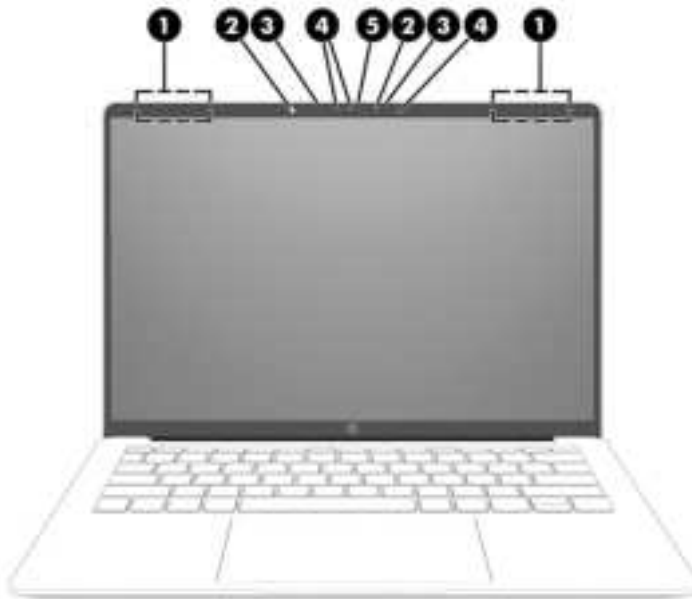

Table 2-3 Display components and their descriptions

	Component	Description
(1)	WLAN antennas* (2)	Send and receive wireless signals to communicate with wireless local area networks (WLANs).
(2)	Camera lights (2)	On: One or more cameras are in use.

Table 2-3 Display components and their descriptions (continued)

Component	Description
(3) Internal microphones (2)	Record sound.
(4) Cameras (2)	Allow you to video chat, record video, and record still images. Some cameras also allow a facial recognition logon to Windows, instead of a password logon. NOTE: Camera functions vary depending on the camera hardware and software installed on your product.
(5) Camera privacy cover	By default, the camera lens is uncovered, but you can slide the camera privacy cover to block the camera's view. To use the camera, slide the camera privacy cover in the opposite direction to reveal the lens.

*The antennas are not visible from the outside of the computer. For optimal transmission, keep the areas immediately around the antennas free from obstructions.

For wireless regulatory notices, see the section of the *Regulatory, Safety, and Environmental Notices* that applies to your country or region.

To access this guide:

- Select the **Search** icon in the taskbar, type `HP Documentation` in the search box, and then select **HP Documentation**.

Keyboard area

Keyboards can vary by language.

 **NOTE:** The keyboard area, including the function keys and (select products only) power key, is disabled in stand, tent, and tablet modes. To enable the keyboard, including the power key, change to the clamshell mode.

Touchpad settings and components

Learn the touchpad settings and components.

Touchpad settings

Learn how to adjust touchpad settings.

Adjusting touchpad settings

Use these steps to adjust touchpad settings and gestures.

1. Select the **Search** icon in the taskbar, type `touchpad settings` in the search box, and then press `enter`.
2. Choose a setting.

Turning on the touchpad

Follow these steps to turn on the touchpad.

1. Select the **Search** icon in the taskbar, type `touchpad settings` in the search box, and then press `enter`.
2. Using an external mouse, click the **touchpad** button.

If you are not using an external mouse, press the `Tab` key repeatedly until the pointer rests on the **touchpad** button. Then press the `spacebar` to select the button.

Touchpad components

Use this illustration and table to identify the touchpad components.

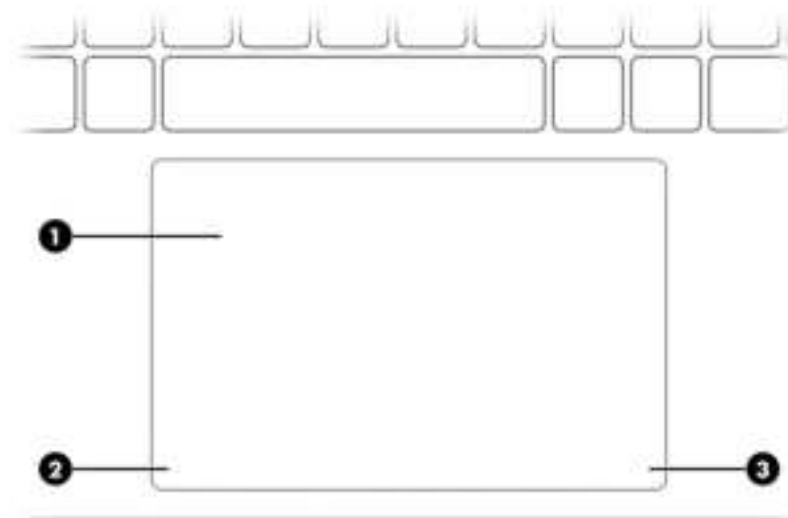

Table 2-4 Touchpad components and their descriptions

	Component	Description
(1)	Touchpad zone	Reads your finger gestures to move the pointer or activate items on the screen.
(2)	Left touchpad button	Functions like the left button on an external mouse.
(3)	Right touchpad button	Functions like the right button on an external mouse.

Lights

Use this illustration and table to identify the lights on the computer.

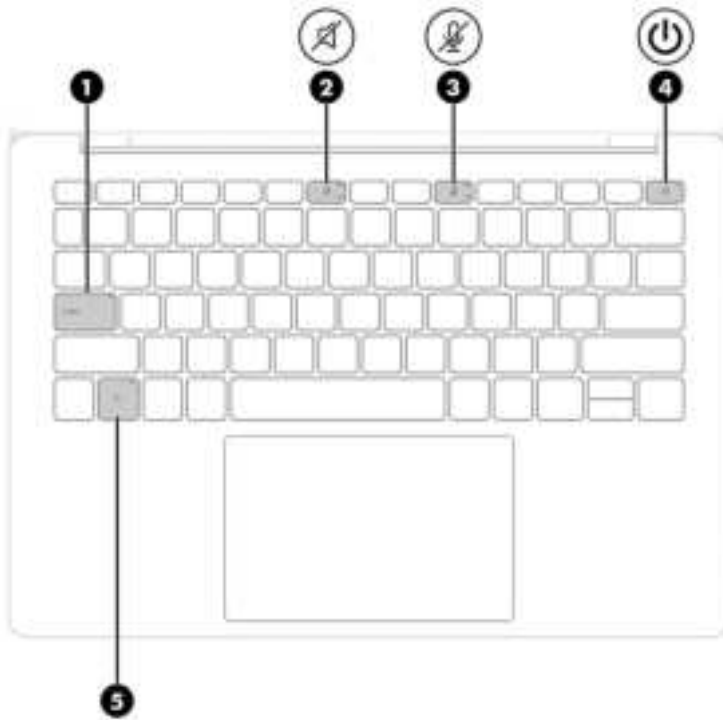





Table 2-5 Lights and their descriptions

	Component	Description
(1)	Caps lock light	On: Caps lock is on, which switches the key input to all capital letters.
(2)	 Mute light	<ul style="list-style-type: none"> On: Computer sound is off. Off: Computer sound is on.
(3)	 Microphone mute light	<ul style="list-style-type: none"> On: Microphone is off. Off: Microphone is on.
(4)	 Power light	<ul style="list-style-type: none"> On: The computer is on. Blinking (select products only): The computer is in the sleep state, a power-saving state. The computer shuts off power to the display and other unnecessary components. Off: Depending on your computer model, the computer is off, in hibernation, or in sleep. Hibernation is the power-saving state that uses the least amount of power.
(5)	Fn lock light	<ul style="list-style-type: none"> On: FN Lock is enabled. Off: FN Lock is disabled. <p>NOTE: On some products, FN Lock is assigned as the secondary function of the left Shift key. To enable FN Lock, press fn + left Shift. Repeat the same key combination again to disable FN Lock.</p>

Special keys

Use this illustration to identify the special keys.

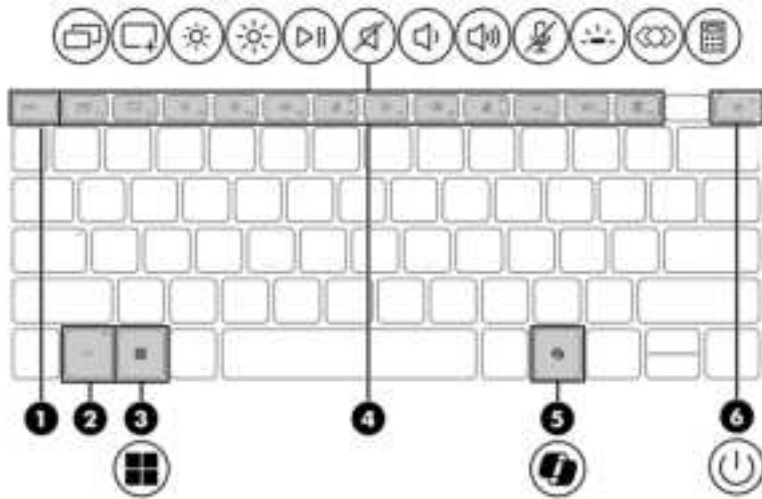



Table 2-6 Special keys and their descriptions

	Component	Description
(1)	esc key	Displays system information when pressed in combination with the fn key.
(2)	fn key	Executes specific functions when pressed in combination with another key.
(3)	Windows key	Opens the Start menu. NOTE: Pressing the Windows key again will close the Start menu.
(4)	Action keys	Execute frequently used system functions as defined by the icon symbols on f1 through f12 function keys.
(5)	Windows Copilot key	Opens Windows Copilot (select products only). NOTE: Copilot in Windows (select products only) requires Windows 11. Some features require a neural processing unit (NPU). The timing of feature delivery and availability varies by market and device. You must have a Microsoft account to use the Copilot feature. When the Copilot feature is not available, pressing the Copilot key opens the Bing search engine. See http://aka.ms/WindowsAIFeatures .

Table 2-6 Special keys and their descriptions (continued)

	Component	Description
(6)	 Power key	<ul style="list-style-type: none">• When the computer is off, press the button briefly to turn on the computer.• When the computer is on, press the button briefly to initiate sleep.• When the computer is in the sleep state, press the button briefly to exit sleep (select products only).• When the computer is in hibernation, press the button briefly to exit hibernation. <p>IMPORTANT: Pressing and holding down the power button results in the loss of unsaved information.</p> <p>If the computer has stopped responding and shutdown procedures are ineffective, press and hold the power button down for at least 10 seconds to turn off the computer.</p> <p>To learn more about your power and sleep settings:</p> <ul style="list-style-type: none">■ Right-click the Power icon , and then select Power and sleep settings.

Bottom

Identify the bottom components.

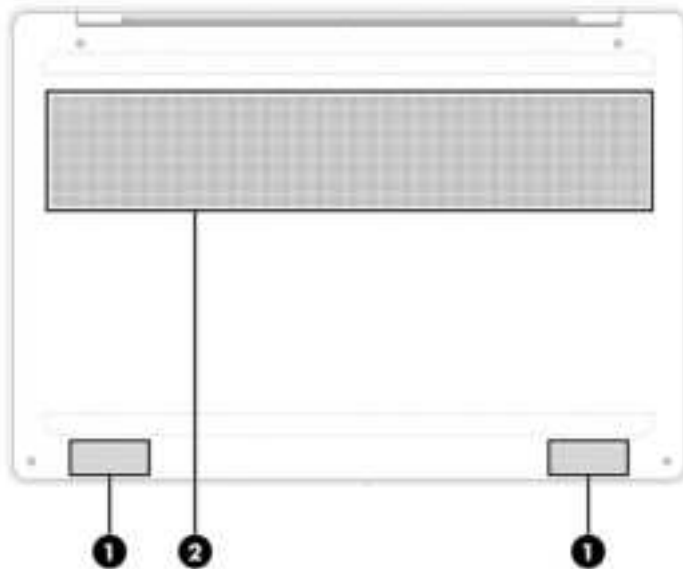

Table 2-7 Bottom components and their descriptions

	Component	Description
(1)	Speakers	Produce sound.

Table 2-7 Bottom components and their descriptions (continued)

	Component	Description
(2)	Vent	Enables airflow to cool internal components. NOTE: The computer fan starts up automatically to cool internal components and prevent overheating. It is normal for the internal fan to cycle on and off during routine operation.

Labels

The labels affixed to the computer provide information that you might need when you troubleshoot system problems or travel internationally with the computer. Labels can be in paper form or imprinted on the product.

IMPORTANT: Check the following locations for the labels described in this section: the bottom of the computer, inside the battery bay, under the service door, on the back of the display, or on the bottom of a tablet kickstand.

- Service label—Provides important information to identify your computer. When contacting support, you might be asked for the serial number, the product number, or the model number. Locate this information before you contact support.

Your service label will resemble the following example:

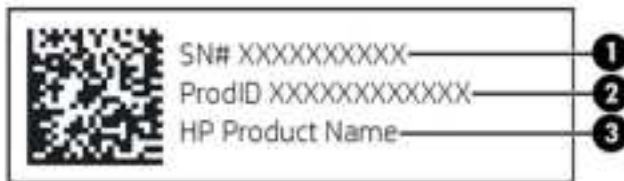

Table 2-8 Service label components

Component
(1) Serial number
(2) Product ID
(3) HP product name and model number

- Regulatory labels—Provide regulatory information about the computer.
- Wireless certification labels—Provide information about optional wireless devices and the approval markings for the countries or regions in which the devices have been approved for use.

3 Illustrated parts catalog

Use this chapter to determine the spare parts that are available for the computer.

Computer major components

Use this illustration and table to identify the computer major components.

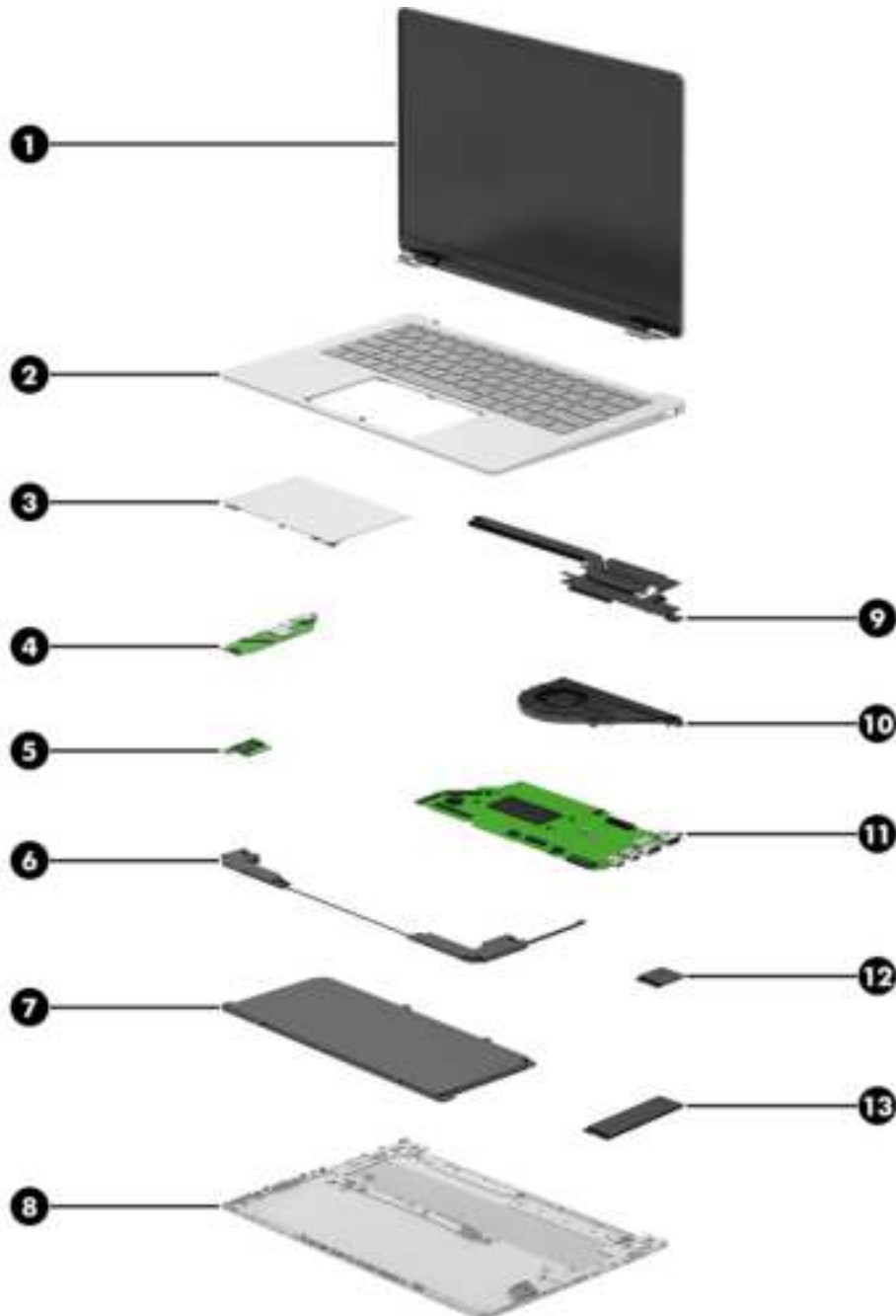

Table 3-1 Computer major component descriptions and part numbers

Item	Component	CSR category*	Spare part number
(1)	Display assembly NOTE: Display assemblies are offered as spare parts only at a subcomponent level.		not available as a spare part
(2)	Top cover with keyboard NOTE: For a detailed list of country codes, see Top cover with keyboard on page 66 .		
	Canvas gray	N	P82013-xx1
	Darker meteor silver	N	P82014-xx1
	Darker sahara silver	N	P82015-xx1
	Darker starlit blue	N	P82016-xx1
(3)	Touchpad (includes cable)		
	Glacier silver	N	P84322-001
	Meteor silver	N	P84323-001
	Sahara silver	N	P84324-001
	Starlit blue	N	P84325-001
(4)	I/O board (includes cable)		P84310-001
(5)	OLED PMIC board	N	P83616-001
(6)	Speakers (left and right)	N	P84315-001
(7)	Battery (3 cell, 59 Wh; includes revive kit)	A	N66215-001
(8)	Bottom cover		
	Glacier silver	A	P84306-001
	Meteor silver	A	P84307-001
	Sahara silver	A	P84308-001
	Starlit blue	A	P84309-001
(9)	Heat sink		
	Heat sink (Intel Core processors)		P84316-001
	Heat sink (Intel Core Ultra processors)	N	P84317-001
	Heat sink (AMD Ryzen 7 and Ryzen 5 processors)	N	P84319-001
	Heat sink (AMD Ryzen AI 9 and AI 7 processors)	N	P84320-001
	Heat sink (AMD Ryzen AI 5 processors)	N	P84321-001
	Heat sink (AMD Ryzen AI 5 330 processor)	N	Q06613-001
(10)	Fan	N	P83622-001
(11)	System board for use in models with an Intel processor		
	Intel Core 7 150U processor and 16 GB system memory	N	P82019-601

Table 3-1 Computer major component descriptions and part numbers (continued)

Item	Component	CSR category*	Spare part number
	Intel Core 7 150U processor and 16 GB system memory (PRC)	N	P82020-601
	Intel Core 5 120U processor and 16 GB system memory	N	P82017-601
	Intel Core 5 120U processor and 16 GB system memory (PRC)	N	P82018-601
	Intel Core Ultra 5 H204 and 16 GB system memory	N	P82021-601
	Intel Core Ultra 7 404 and 16 GB system memory	N	P82022-601
	Intel Core Ultra 7 404 and 32 GB system memory	N	P82023-601
	Intel Core Ultra 9 484 and 32 GB system memory	N	P82024-601
	Intel Core Ultra 9 484 and 32 GB system memory (PRC)	N	P82025-601
	PTL U SH 444 and 16 GB system memory (PRC)	N	P82026-601
	PTL U SH 444 and 32 GB system memory (PRC)	N	P82027-601
	System board for use in models with an AMD processor		
	AMD Ryzen AI 9 H 465 processor and 32 GB system memory (PRC)	N	P82041-601
	AMD Ryzen AI 9 465 processor and 32 GB system memory	N	P82040-601
	AMD Ryzen AI 7 445 processor and 32 GB system memory (PRC)	N	P82038-601
	AMD Ryzen AI 7 445 processor and 16 GB system memory	N	P82036-601
	AMD Ryzen AI 7 H 445 processor and 32 GB system memory (PRC)	N	P82039-601
	AMD Ryzen AI 7 H 445 processor and 16 GB system memory (PRC)	N	P82037-601
	AMD Ryzen AI 5 430 processor and 16 GB system memory	N	P82034-601
	AMD Ryzen AI 5 H 430 processor and 16 GB system memory (PRC)	N	P82035-601
	AMD Ryzen AI 5 330 processor and 32 GB system memory	N	Q05080-601
	AMD Ryzen AI 5 330 processor and 32 GB system memory (PRC)	N	Q05082-601
	AMD Ryzen AI 5 330 processor and 16 GB system memory	N	Q05079-601
	AMD Ryzen AI 5 330 processor and 16 GB system memory (PRC)	N	Q05081-601
	AMD Ryzen 7 250 processor and 32 GB system memory	N	P82044-601
	AMD Ryzen 7 250 processor and 32 GB system memory (PRC)	N	P82045-601
	AMD Ryzen 7 250 processor and 16 GB system memory	N	P82042-601
	AMD Ryzen 7 250 processor and 16 GB system memory (PRC)	N	P82043-601
	AMD Ryzen 5 230 processor and 16 GB system memory	N	P82046-601
	AMD Ryzen 5 230 processor and 16 GB system memory (PRC)	N	P82047-601
(12)	WLAN module for use in models with an Intel processor		
	Realtek Wi-Fi 6 RTL8852BE-VT + Bluetooth 5.4	N	P06350-005
	Realtek Wi-Fi 7 RTL8922AE-VS + Bluetooth 6.0	N	P44408-005
	Intel Wi-Fi 7 R2 BE211 + Bluetooth 6.0	N	P36621-005
	WLAN module for use in models with an AMD processor		

Table 3-1 Computer major component descriptions and part numbers (continued)

Item	Component	CSR category*	Spare part number
	MediaTek MT7920 Wi-Fi 6 + Bluetooth 5.4	N	P17386-005
	Realtek Wi-Fi 7 RTL8922AE-VS + Bluetooth 6.0	N	P44408-005
(13)	SSD (PCIe)		
	1 TB, Gen5 (Intel models only)	N	P73030-005
	512 GB, Gen5 (Intel models only)	N	P73029-005
	1 TB, Gen4	N	N77394-005
	512 GB, Gen4	N	N77392-005
	256 GB, Gen4	N	N77391-005

Table 3-2 CSR part categories*

Category	Description	Replacement responsibility
CSR A	Self-service parts	Customers can replace these easily replaceable parts. Replacement by trained technicians might incur additional cost.
CSR B/C	Optional self-service parts	Skilled customers can replace these parts. Warranty replacement available via trained technicians.
CSR N	Non-self-service parts	Only trained service technicians should replace these complex parts.

Display assembly subcomponents

Use this illustration and table to identify the display assembly subcomponents.

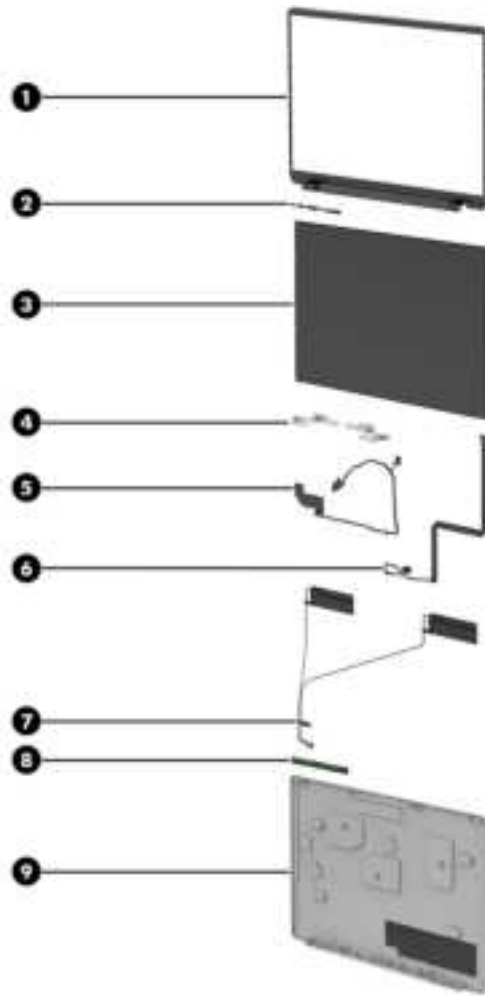

Table 3-3 Display component descriptions and part numbers

Item	Component	Spare part number
(1)	Display bezel	P84337-001
(2)	Camera module (includes rubber bumpers, foil, and tape)	P84334-001
(3)	Display panel (includes cable, bezel adhesive, and panel stretchable adhesive tape)	
	2.8K, 500 nits	P82033-001
	WUXGA, DBTS, 300 nits	P82032-001
	WUXGA, NTS, 300 nits	P82031-001
(4)	Hinges (left and right)	P84336-001
(5)	Display panel cable	
	Intel models	P84311-001
	AMD models	P84312-001
(6)	Camera cable (included in the Cable Kit)	P84313-001
(7)	Wireless antenna kit (included in the Cable Kit)	P84313-001

Table 3-3 Display component descriptions and part numbers (continued)

Item	Component	Spare part number
(8)	Touch control board	
	Intel models	P84338-001
	AMD models	P84452-001
(9)	Display back cover (includes wireless antennas and panel stretchable adhesive tape)	
	Glacier silver, touch screen models	P84326-001
	Meteor silver, touch screen models	P84327-001
	Sahara silver, touch screen models	P84328-001
	Starlit blue, touch screen models	P84329-001
	Glacier silver, nontouch screen models	P84330-001
	Meteor silver, nontouch screen models	P84331-001
	Sahara silver, nontouch screen models	P84332-001
	Starlit blue, nontouch screen models	P84333-001

Miscellaneous parts

Use this table to identify the miscellaneous parts.

Table 3-4 Miscellaneous part descriptions and part numbers

Component	Spare part number
Screw and Misc Parts Kit (includes all screws, WLAN module protective tape, WLAN thermal pads, and protective shielding)	P84314-001
Cable and Antenna Kit (includes I/O board cable, touchpad cable, battery cable, camera cable, and bezel and touch screen tape)	P84313-001
Display Cable Kit (Intel models) (includes tape)	P84311-001
Display Cable Kit (AMD models) (includes tape)	P84312-001
HP Everyday 16 Laptop Backpack	P04346-001
HP 400/405 Quiet Mouse (black)	P22368-001
HP 400/405 Quiet Mouse (blue)	P22606-001
HP 400/405 Quiet Mouse (pink)	P22607-001
AC adapter (USB-C)	
65 W, wall mount, 2 pin	P68491-001
65 W, standard, straight	P38779-001
65 W, GaN, wall mount, fixed, 2 pin, 2 m (6.6 ft)	P58629-001
65 W, GaN, wall mount, fixed, 2 pin, 2 m (6.6 ft), IN	P73759-001
65 W, GaN, wall mount, free, 2 pin, 2 m (6.6 ft)	P58630-001
Duckhead power cord (non-standard, halogen free)	

Table 3-4 Miscellaneous part descriptions and part numbers (continued)

Component	Spare part number
Argentina	P57788-001
Australia	P57784-001
Europe (Austria, Belgium, Finland, France, Germany, the Netherlands, Norway, and Sweden)	P57782-001
South Korea	P57785-001
Thailand	P57786-001
United Kingdom	P57783-001
Power cords (C5, conventional, straight, 1.0 m [3.3 ft])	
Argentina	L19357-001
Australia	L19358-001
Denmark	L19360-001
Europe (Austria, Belgium, Finland, France, Germany, the Netherlands, Norway, and Sweden)	L19361-001
India	L19363-001
Israel	L19362-001
Italy	L19364-001
Japan	L19365-001
North America	L19367-001
PRC	L19368-001
South Africa	L19369-001
South Korea	L19366-001
Switzerland	L19370-001
Taiwan	L19372-001
Thailand	L19371-001
Thailand (bundle)	M85418-001
United Kingdom	L19373-001

4 Removal and replacement procedures preliminary requirements

Use this information to properly prepare to disassemble and reassemble the computer.

Tools required

You need the following tools to complete the removal and replacement procedures.

- Heat gun
- Tweezers
- Nonconductive, nonmarking pry tool
- Magnetic Phillips P1 screwdriver

Service considerations

The following sections include some of the considerations that you must keep in mind during disassembly and assembly procedures.

 **NOTE:** As you remove each subassembly from the computer, place the subassembly and all accompanying screws away from the work area to prevent damage.

Plastic parts

Using excessive force during disassembly and reassembly can damage plastic parts.

Cables and connectors

Handle cables with extreme care to avoid damage.

 **IMPORTANT:** When servicing the computer, be sure that cables are placed in their proper locations during the reassembly process. Improper cable placement can damage the computer.

Apply only the tension required to unseat or seat the cables during removal and insertion. Handle cables by the connector whenever possible. In all cases, avoid bending, twisting, or tearing cables. Be sure that cables are routed so that they cannot be caught or snagged as you remove or replace parts. Handle flex cables with extreme care; these cables tear easily.

Drive handling

Note the following guidelines when handling drives.

 **IMPORTANT:** Drives are fragile components. Handle them with care. To prevent damage to the computer, damage to a drive, or loss of information, observe these precautions:

- Before removing or inserting a hard drive, shut down the computer. If you are unsure whether the computer is off or in hibernation or sleep mode, turn the computer on, and then shut it down through the operating system.
 - Before handling a drive, be sure that you are discharged of static electricity. While handling a drive, avoid touching the connector.
 - Before removing an optical drive, be sure that a disc is not in the drive, and be sure that the optical drive tray is closed.
 - Handle drives on surfaces covered with at least 2.54 cm (1 inch) of shock-proof foam.
 - Avoid dropping drives from any height onto any surface.
 - After removing a hard drive or an optical drive, place it in a static-proof bag.
 - Avoid exposing an internal hard drive to products that have magnetic fields, such as monitors or speakers.
 - Avoid exposing a drive to temperature extremes or liquids.
 - If a drive must be mailed, place the drive in a bubble pack mailer or other suitable form of protective packaging, and label the package "FRAGILE."
-

Electrostatic discharge information

A sudden discharge of static electricity from your finger or other conductor can destroy static-sensitive devices or microcircuitry. Often the spark is neither felt nor heard, but damage occurs. An electronic device exposed to electrostatic discharge (ESD) might not appear to be affected at all and can work perfectly throughout a normal cycle. The device might function normally for a while, but it has been degraded in the internal layers, reducing its life expectancy.

Networks built into many integrated circuits provide some protection, but in many cases, the discharge contains enough power to alter device parameters or melt silicon junctions.

 **IMPORTANT:** To prevent damage to the device when you remove or install internal components, observe these precautions:

- Keep components in their electrostatic-safe containers until you are ready to install them.
 - Before touching an electronic component, discharge static electricity by using the guidelines described in [Personal grounding methods and equipment on page 24](#).
 - Avoid touching pins, leads, and circuitry. Handle electronic components as little as possible.
 - If you remove a component, place it in an electrostatic-safe container.
-

Generating static electricity

Follow these static electricity guidelines.

- Different activities generate different amounts of static electricity.
- Static electricity increases as humidity decreases.

Table 4-1 Static electricity occurrence based on activity and humidity

Event	55% relative humidity	40% relative humidity	10% relative humidity
Walking across carpet	7500 V	15,000 V	35,000 V
Walking across vinyl floor	3000 V	5000 V	12,000 V
Motions of bench worker	400 V	800 V	6000 V
Removing dual in-line packages (DIPs) from plastic tube	400 V	700 V	2000 V
Removing DIPs from vinyl tray	2000 V	4000 V	11,500 V
Removing DIPs from polystyrene foam	3500 V	5000 V	14,500 V
Removing bubble pack from PCB (printed circuit board)	7000 V	20,000 V	26,500 V
Packing PCBs in foam-lined box	5000 V	11,000 V	21,000 V

 **NOTE:** Multiple electric components can be packaged together in plastic tubes, trays, or polystyrene foam.

 **NOTE:** As little as 700 V of static electricity can degrade a product.

Preventing electrostatic damage to equipment

Many electronic components are sensitive to ESD. Circuitry design and structure determine the degree of sensitivity.

The following packaging and grounding precautions are necessary to prevent static electricity damage to electronic components:

- To avoid hand contact, transport products in static-safe containers such as tubes, bags, or boxes.
- Protect all electrostatic parts and assemblies with conductive or approved containers or packaging.
- Keep electrostatic-sensitive parts in their containers until they arrive at static-free stations.
- Place items on a grounded surface before removing them from their container.
- Always be properly grounded when touching a sensitive component or assembly.
- Avoid contact with pins, leads, or circuitry.
- Place reusable electrostatic-sensitive parts from assemblies in protective packaging or conductive foam.

Personal grounding methods and equipment

Using certain equipment can prevent static electricity damage to electronic components.

- **Wrist straps** are flexible straps with a maximum of $1\text{ M}\Omega \pm 10\%$ resistance in the ground cords. To provide proper ground, wear a strap snug against bare skin. Verify that the ground cord is connected and fits snugly into the banana plug connector on the grounding mat or workstation.
- You can use **heel straps, toe straps, and boot straps** at standing workstations. These straps are compatible with most types of shoes or boots. On conductive floors or dissipative floor mats, use them on both feet with a maximum of $1\text{ M}\Omega \pm 10\%$ resistance between the operator and ground.

Table 4-2 Static shielding protection levels

Method	Voltage
Antistatic plastic	1500
Carbon-loaded plastic	7500
Metalized laminate	15,000

Grounding the work area

To prevent static damage at the work area, follow these precautions.

- Cover the work surface with approved static-dissipative material.
- Use a wrist strap connected to a properly grounded work surface and use properly grounded tools and equipment.
- Use static-dissipative mats, foot straps, or air ionizers to give added protection.
- Handle electrostatic sensitive components, parts, and assemblies by the case or PCB laminate. Handle them only at static-free work areas.
- Turn off power and input signals before inserting and removing connectors or test equipment.
- Use fixtures made of static-safe materials when fixtures must directly contact dissipative surfaces.
- Keep the work area free of nonconductive materials, such as ordinary plastic assembly aids and polystyrene foam.
- Use conductive field service tools, such as cutters, screwdrivers, and vacuums.
- Avoid contact with pins, leads, or circuitry.

Recommended materials and equipment

HP recommends certain materials and equipment to prevent static electricity.

- Antistatic tape
- Antistatic smocks, aprons, or sleeve protectors
- Conductive bins and other assembly or soldering aids
- Conductive foam
- Conductive tabletop workstations with ground cord of $1\text{ M}\Omega \pm 10\%$ resistance
- Static-dissipative table or floor mats with hard tie to ground
- Field service kits
- Static awareness labels
- Wrist straps and footwear straps providing $1\text{ M}\Omega \pm 10\%$ resistance
- Material handling packages
- Conductive plastic bags

- Conductive plastic tubes
- Conductive tote boxes
- Opaque shielding bags
- Transparent metallized shielding bags
- Transparent shielding tubes

Cleaning your computer

Cleaning your computer regularly removes dirt and debris so that your device continues to operate at its best. Use the following information to safely clean the external surfaces of your computer.

Enabling HP Easy Clean (select products only)

HP Easy Clean helps you to avoid accidental input while you clean the computer surfaces. This software disables devices such as the keyboard, touch screen, and touchpad for a preset amount of time so that you can clean all computer surfaces.

1. Start HP Easy Clean in one of the following ways:
 - Select the **Start** menu, and then select **HP Easy Clean**.
 - Select the **HP Easy Clean** icon in the taskbar.
 - Select **Start**, and then select the **HP Easy Clean** tile.
2. Now that your device is disabled for a short period, see [Removing dirt and debris from your computer on page 26](#) for the recommended steps to clean the high-touch, external surfaces on your computer. After you remove the dirt and debris, you can also clean the surfaces with a disinfectant. See [Cleaning your computer with a disinfectant on page 27](#) for guidelines to help prevent the spread of harmful bacteria and viruses.

Removing dirt and debris from your computer

Here are the recommended steps to clean dirt and debris from your computer.

For computers with wood veneer, see [Caring for wood veneer \(select products only\) on page 28](#).

1. Wear disposable gloves made of latex (or nitrile gloves, if you are latex-sensitive) when cleaning the surfaces.
2. Turn off your device and unplug the power cord and other connected external devices. Remove any installed batteries from items such as wireless keyboards.

 **CAUTION:** To prevent electric shock or damage to components, never clean a product while it is turned on or plugged in.

3. Moisten a microfiber cloth with water. The cloth should be moist, but not dripping wet.

 **IMPORTANT:** To avoid damaging the surface, avoid abrasive cloths, towels, and paper towels.

4. Wipe the exterior of the product gently with the moistened cloth.

 **IMPORTANT:** Keep liquids away from the product. Avoid getting moisture in any openings. If liquid makes its way inside your HP product, it can cause damage to the product. Do not spray liquids directly on the product. Do not use aerosol sprays, solvents, abrasives, or cleaners containing hydrogen peroxide or bleach that might damage the finish.

5. Start with the display (if applicable). Wipe carefully in one direction, and move from the top of the display to the bottom. Finish with any flexible cables, like power cord, keyboard cable, and USB cables.
6. Be sure that surfaces have completely air-dried before turning the device on after cleaning.
7. Discard the gloves after each cleaning. Clean your hands immediately after you remove the gloves.

See [Cleaning your computer with a disinfectant on page 27](#) for recommended steps to clean the high-touch, external surfaces on your computer to help prevent the spread of harmful bacteria and viruses.

Cleaning your computer with a disinfectant

The World Health Organization (WHO) recommends cleaning surfaces, followed by disinfection, as a best practice for preventing the spread of viral respiratory illnesses and harmful bacteria.

After cleaning the external surfaces of your computer using the steps in [Removing dirt and debris from your computer on page 26](#), [Caring for wood veneer \(select products only\) on page 28](#), or both, you might also choose to clean the surfaces with a disinfectant. A disinfectant that is within HP's cleaning guidelines is an alcohol solution consisting of 70% isopropyl alcohol and 30% water. This solution is also known as rubbing alcohol and is sold in most stores.

Follow these steps when disinfecting high-touch, external surfaces on your computer:

1. Wear disposable gloves made of latex (or nitrile gloves, if you are latex-sensitive) when cleaning the surfaces.
2. Turn off your device and unplug the power cord and other connected external devices. Remove any installed batteries from items such as wireless keyboards.

 **CAUTION:** To prevent electric shock or damage to components, never clean a product while it is turned on or plugged in.

3. Moisten a microfiber cloth with a mixture of 70% isopropyl alcohol and 30% water. The cloth should be moist, but not dripping wet.

 **CAUTION:** Do not use any of the following chemicals or any solutions that contain them, including spray-based surface cleaners: bleach, peroxides (including hydrogen peroxide), acetone, ammonia, ethyl alcohol, methylene chloride, or any petroleum-based materials, such as gasoline, paint thinner, benzene, or toluene.

 **IMPORTANT:** To avoid damaging the surface, avoid abrasive cloths, towels, and paper towels.

4. Wipe the exterior of the product gently with the moistened cloth.

 **IMPORTANT:** Keep liquids away from the product. Avoid getting moisture in any openings. If liquid makes its way inside your HP product, it can cause damage to the product. Do not spray liquids directly on the product. Do not use aerosol sprays, solvents, abrasives, or cleaners containing hydrogen peroxide or bleach that might damage the finish.

5. Start with the display (if applicable). Wipe carefully in one direction, and move from the top of the display to the bottom. Finish with any flexible cables, like power cord, keyboard cable, and USB cables.
6. Be sure that surfaces have completely air-dried before turning the device on after cleaning.
7. Discard the gloves after each cleaning. Clean your hands immediately after you remove the gloves.

Caring for wood veneer (select products only)

Your product might feature high-quality wood veneer. As with all natural wood products, proper care is important for best results over the life of the product. Because of the nature of natural wood, you might see unique variations in the grain pattern or subtle variations in color, which are normal.

- Clean the wood with a dry, static-free microfiber cloth or chamois.
- Avoid cleaning products containing substances such as ammonia, methylene chloride, acetone, turpentine, or other petroleum-based solvents.
- Do not expose the wood to sun or moisture for long periods of time.
- If the wood becomes wet, dry it by dabbing with an absorbent, lint-free cloth.
- Avoid contact with any substance that might dye or discolor the wood.
- Avoid contact with sharp objects or rough surfaces that might scratch the wood.

See [Removing dirt and debris from your computer on page 26](#) for the recommended steps to clean the high-touch, external surfaces on your computer. After you remove the dirt and debris, you can also clean the surfaces with a disinfectant. See [Cleaning your computer with a disinfectant on page 27](#) for sanitizing guidelines to help prevent the spread of harmful bacteria and viruses.

Packaging and transporting guidelines

Follow these grounding guidelines when packaging and transporting equipment.

- To avoid hand contact, transport products in static-safe tubes, bags, or boxes.
- Protect ESD-sensitive parts and assemblies with conductive or approved containers or packaging.
- Keep ESD-sensitive parts in their containers until the parts arrive at static-free workstations.
- Place items on a grounded surface before removing items from their containers.
- Always be properly grounded when touching a component or assembly.
- Store reusable ESD-sensitive parts from assemblies in protective packaging or nonconductive foam.
- Use transporters and conveyors made of antistatic belts and roller bushings. Be sure that mechanized equipment used for moving materials is wired to ground and that proper materials are selected to avoid static charging. When grounding is not possible, use an ionizer to dissipate electric charges.

Accessing support information

Use this information to find the HP support that you need.

Table 4-3 Support information locations

Service consideration	Path to access information
<p>Records of reported failure incidents stored on the computer</p>	<p>Windows:</p> <p>Pre-operating system failures are logged in the BIOS Event Log. To view the BIOS Event Log:</p> <ol style="list-style-type: none"> 1. Press the power button. 2. Immediately and repeatedly press esc when the power button light turns white. <p>NOTE: If you do not press esc at the appropriate time, you must restart the computer and again repeatedly press esc when the power button light turns white to access the utility.</p> <ol style="list-style-type: none"> 3. Press f10 to enter the BIOS setup. 4. Complete one of these tasks: <ul style="list-style-type: none"> • (On commercial products) Under the Main tab, select BIOS event log, and then select View BIOS Event Log. • (On consumer products) Under the Main tab, select System Log. <p>Post-operating system failures are logged in the Event Viewer.</p> <ol style="list-style-type: none"> 1. Turn on the computer and allow the operating system to open. 2. Select the search icon  in the taskbar. 3. Type <code>Event Viewer</code>, and then press enter. 4. Select the log from the left panel. Details display in the right panel. <p>ChromeOS™:</p> <ol style="list-style-type: none"> 1. Go to support.google.com/chrome. 2. Search <code>collect Chrome device logs</code>.
<p>Technical bulletins and alerts</p>	<p>To find technical bulletins, alerts, guides, and whitepapers:</p> <ol style="list-style-type: none"> 1. Go to www.hp.com/support. 2. Follow the instructions to find your product. 3. Select Bulletins and Alerts to view technical bulletins.
<p>Repair professionals</p>	<p>To locate repair professionals:</p> <ol style="list-style-type: none"> 1. Go to www.hp.com. 2. Select Authorized service providers. 3. Select your location.
<p>Component and diagnosis information, failure detection, and required action</p>	<p>To locate diagnosis information and actions:</p> <ol style="list-style-type: none"> 1. Go to http://www.hp.com/go/techcenter/pcdiags. 2. Select the issue you want to diagnose.

5 Removal and replacement procedures for Customer Self-Repair parts

This chapter provides removal and replacement procedures for Customer Self-Repair parts.

 **NOTE:** The Customer Self-Repair program is not available in all locations. Installing a part that is not supported by the Customer Self-Repair program can void your warranty. Check your warranty to determine whether Customer Self-Repair is supported in your location.

 **NOTE:** The [HP Support YouTube Channel](#) (in English) has videos that provide step-by-step removal and replacement instructions for many common parts and models.

Component replacement procedures

Use these procedures to remove and replace computer components.

 **NOTE:** Details about your computer, including model, serial number, product key, and length of warranty, are on the service tag at the bottom of your computer.

 **NOTE:** HP continually improves and changes product parts. For complete and current information about supported parts for your computer, go to <https://partsurfer.hp.com/>, select your country or region, and then follow the on-screen instructions.

Make special note of each screw size and location during removal and replacement.

Preparation for disassembly

Use these procedures to remove and replace computer components.

For initial safety procedures, see [Removal and replacement procedures preliminary requirements on page 22](#).

1. Turn off the computer. If you are unsure whether the computer is off or in hibernation or sleep mode, turn the computer on, and then shut it down through the operating system.
2. Disconnect the power from the computer by unplugging the power cord from the computer.
3. Disconnect all external devices from the computer.

Bottom cover

Use this procedure and illustration to remove the bottom cover.

Table 5-1 Bottom cover descriptions and part numbers

Description	Spare part number
Glacier silver	P84306-001
Meteor silver	P84307-001
Sahara silver	P84308-001

Table 5-1 Bottom cover descriptions and part numbers (continued)

Description	Spare part number
Starlit blue	P84309-001

Before removing the bottom cover, prepare the computer for disassembly (see [Preparation for disassembly on page 30](#)).

Remove the bottom cover:

1. Position the computer upside down.
2. Loosen the four captive Phillips screws on the bottom cover.

 **NOTE:** The bottom cover includes a captive (not removable) screw that causes the cover to pop up when you loosen the screw. After the cover pops up, do not continue to loosen the captive screw.

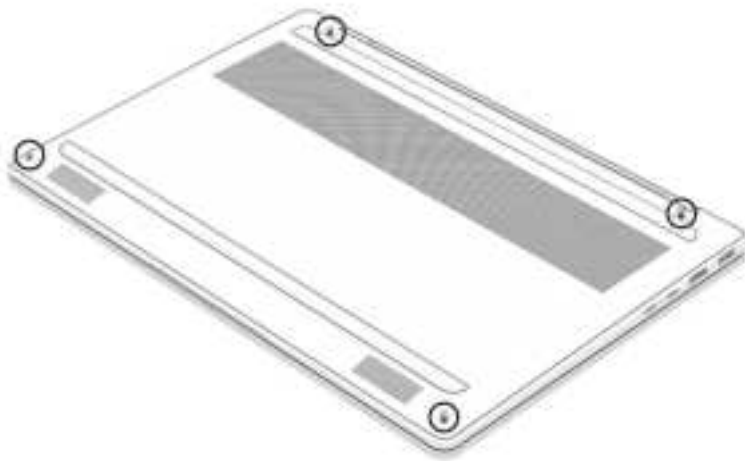

3. Insert a tool **(1)** into the seam near the captive screw at the top left of the bottom cover.
4. Pull the tool **(2)** along to top of the bottom cover to release it.

5. Remove the bottom of the bottom cover (3) from the computer.



Reverse the removal procedures to replace the bottom cover.

When replacing the bottom cover, remove the Feature Byte label from the inside of the old bottom cover and place it on the inside of the new bottom cover. Be sure to keep this label with the computer, because the label is required for any future repairs.

You can locate product labels:

- Laser etched on the old bottom cover.
- In HP System Information by pressing **fn + esc** when you turn on the computer.

 **NOTE:** Bottom cover appearance might vary.

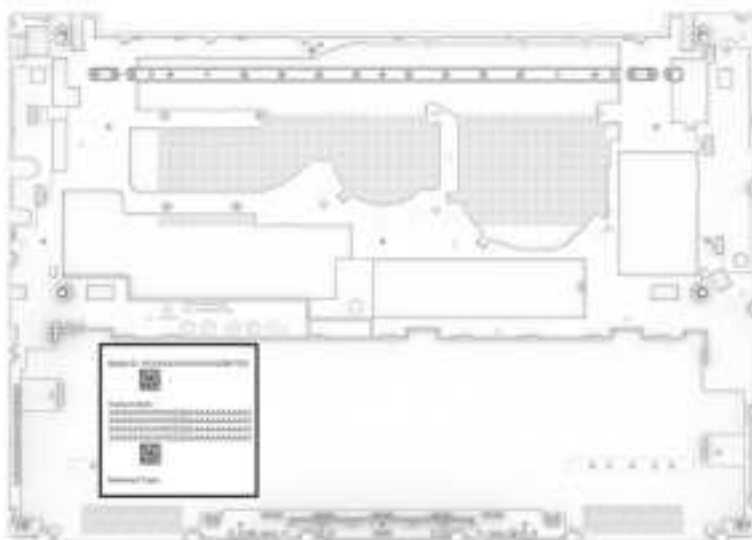

Hand write the product information onto the label of the new bottom cover. Use a ballpoint pen or marker to avoid smudging.

Example of label information

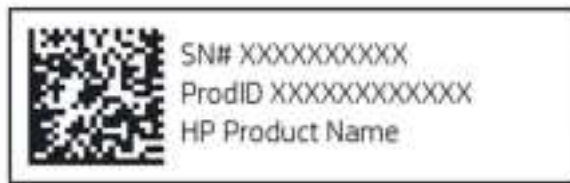

New bottom cover label location

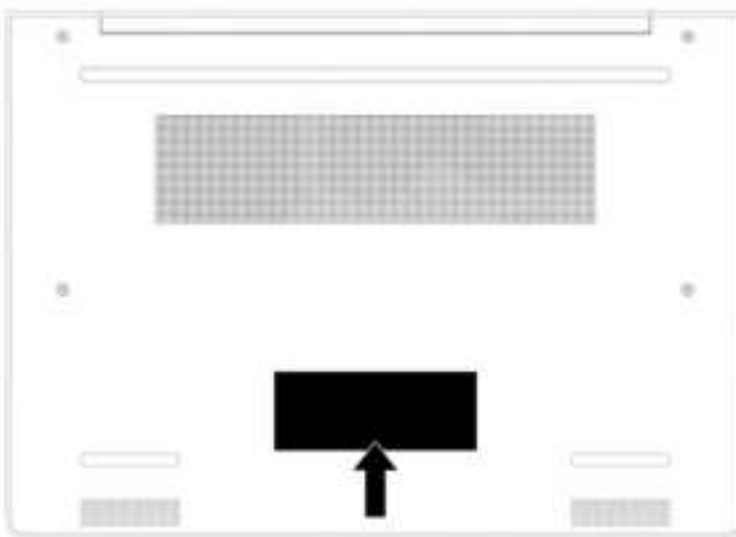

Battery

The battery removal procedure differs depending on whether you are removing and replacing the existing battery or installing a new battery. You must use a revive kit to install a new battery.

- To remove and replace the existing battery, see [Removing and reinstalling the same battery on page 33](#).
- To install a new battery, see [Installing a new battery on page 35](#).

Removing and reinstalling the same battery

Use this procedure and illustration to remove the battery and reinstall it.

⚠ WARNING! To avoid personal injury and damage to the product:

- Do *not* puncture, twist, or crack the battery.
- Do *not* cause an external puncture or rupture to the battery, which can cause a short inside the battery that can result in battery thermal runaway.

- Do *not* handle or touch the battery enclosure with sharp objects such as tweezers or pliers, which might puncture the battery.
- Do *not* compress or squeeze the battery case with tools or heavy objects stacked on top of the case. These actions can apply undue force on the battery.
- Do *not* touch the connectors with any metallic surface or object, such as metal tools, screws, or coins, which can cause shorting across the connectors.

For additional battery information, see the *Regulatory, Safety, and Environmental Notices*. To access this guide, select the **Search** icon in the taskbar, type **HP Documentation** in the search box, and then select **HP Documentation**.

Before removing the battery, follow these steps:

1. Prepare the computer for disassembly (see [Preparation for disassembly on page 30](#)).
2. Remove the bottom cover (see [Bottom cover on page 30](#)).

WARNING! To reduce potential safety issues, use only the user-replaceable battery provided with the computer, a replacement battery provided by HP, or a compatible battery purchased from HP.

IMPORTANT: Removing a battery that is the sole power source for the computer can cause loss of information. To prevent loss of information, save your work or shut down the computer through Windows before you remove the battery.

Remove the battery:

1. Disconnect the battery cable (1) from the system board.
2. Remove the six Phillips M2.0 × 4.0 screws (2) that secure the battery to the computer.
3. Remove the battery (3) from the computer.

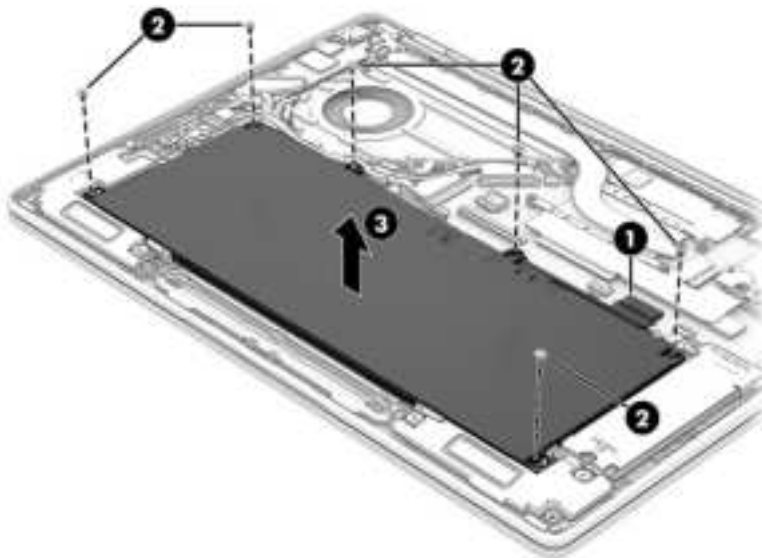

Reverse the removal procedures to reinstall the battery.

 **NOTE:** When replacing the battery, be sure to completely reassemble the computer and plug in the AC adapter before turning the computer on.

Installing a new battery

Use these procedures and illustrations to install a battery. You must use a revive kit to remove the old battery and install a new one. The revive kit includes an empty containment tray and a containment tray with a battery preinstalled.

Table 5-2 Battery description and part number

Description	Spare part number
3 cell, 59 Wh (includes revive kit)	N66215-001

Before starting this replacement procedure:

- Ensure other individuals are sufficiently clear of your workspace.
- Ensure your workspace is clear of any flammable material such as paper or oils.
- Locate the nearest ABC dry chemical fire-extinguisher for use in an emergency.

 **WARNING!** This procedure requires removing the battery or disconnecting the battery cable. Use care to avoid bending, twisting, or puncturing the battery regardless of its condition. Failure to follow this replacement guide or to use HP recommended tools might damage the system and/or cause a safety hazard.

- Do *not* remove the battery from the containment tray.
- Do *not* handle or touch the battery enclosure with sharp objects such as tweezers or pliers, which might puncture the battery.
- Do *not* touch the connectors with any metallic surface or object, such as metal tools, screws, or coins, which can cause shorting across the connectors.

Should a part become stuck or difficult to remove when opening a unit where a swollen battery is suspected, or if the battery becomes stuck in the unit, stop, and contact HP Support for assistance. Do not try to remove a battery by force.

 **NOTE:** Screw locations, latch locations, and internal components might vary.

Before removing the battery, follow these steps:

1. Prepare the computer for disassembly (see [Preparation for disassembly on page 30](#)).
2. Remove the bottom cover (see [Bottom cover on page 30](#)).

 **WARNING!** To reduce potential safety issues, use only the user-replaceable battery provided with the computer, a replacement battery provided by HP, or a compatible battery purchased from HP.

 **IMPORTANT:** Removing a battery that is the sole power source for the computer can cause loss of information. To prevent loss of information, save your work or shut down the computer through Windows before you remove the battery.

1. Remove the battery using the revive kit:

- a. Disconnect the battery cable from the system board. The connector location might vary.

 **NOTE:** You can disconnect the cable from the battery. The battery spare part kit does not come with the battery cable, so be sure to use the old battery cable or order a new battery cable when replacing the battery.

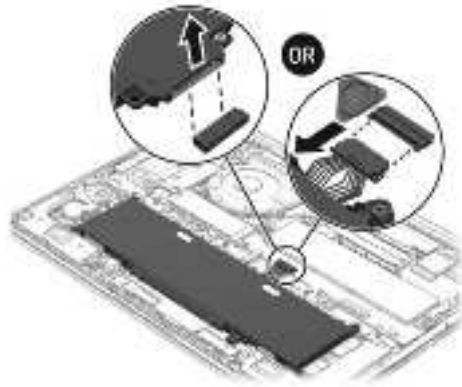

- b. Open the empty battery containment tray.



- c. Remove the paper backing layer from the adhesive on the tray.



- d. Turn the tray **(1)** over so that the adhesive is facing down.
- e. Place the tray **(2)** centered on the battery.
- f. Press down on the indentations on the tray **(3)** to adhere it to the battery.

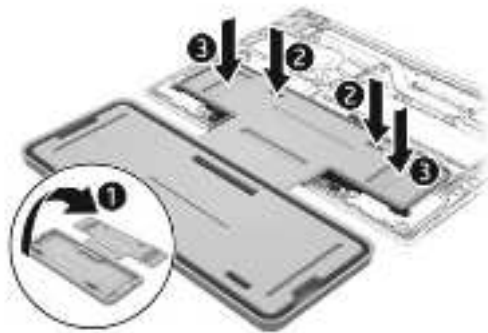

- g. Remove the Phillips screws **(1)** that secure the battery to the computer. Number of screws and screw locations might vary.

- h. Lift the top of the tray (2) to remove the battery from the computer.



- i. Rotate the battery up and over into the cavity of the containment tray.



 **NOTE:** Please recycle responsibly. For more information about recycling programs, see the HP website at <http://www.hp.com/recycle>.

- 2. Install the battery using the revive kit:
 - a. Open the containment tray that includes the new battery.

- b. Turn the tray (1) over so the battery is facing downward, and then insert the battery (2) into the computer. Adhesive secures the battery to the tray.

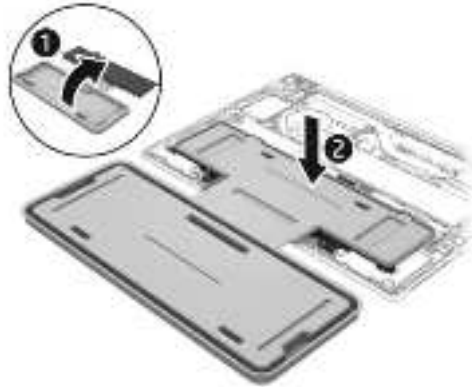

- c. Install the Phillips screws (1) to secure the battery. Number of screws and screw locations might vary.
- d. Lift the containment tray (2) off the battery.



- e. Connect the battery cable to the system board. The connector location might vary.

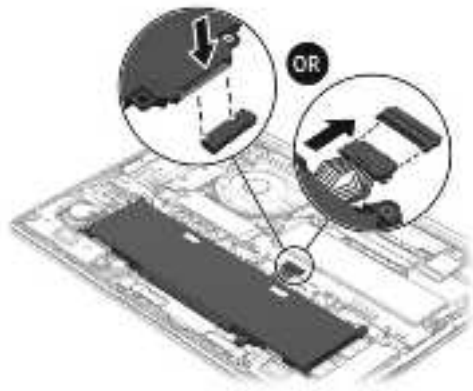



 **NOTE:** When replacing the battery, be sure to completely reassemble the computer and plug in the AC adapter before turning the computer on.

6 Removal and replacement procedures for authorized service provider parts

This chapter provides removal and replacement procedures for authorized service provider parts.

 **IMPORTANT:** Only an authorized service provider should access the components described in this chapter. Accessing these parts can damage the computer or void the warranty.

 **NOTE:** Details about your computer, including model, serial number, product key, and length of warranty, are on the service tag at the bottom of your computer.

 **NOTE:** The [HP Support YouTube Channel](#) (in English) has videos that provide step-by-step removal and replacement instructions for many common parts and models.

Component replacement procedures

Use the procedures described in this section to remove and replace computer components.

 **NOTE:** HP continually improves and changes product parts. For complete and current information about supported parts for your computer, go to <https://partsurfer.hp.com/>, select your country or region, and then follow the on-screen instructions.

Make special note of each screw size and location during removal and replacement.

Solid-state drive

Use this procedure and illustration to remove the SSD.

Table 6-1 SSD descriptions and part numbers

Description	Spare part number
1 TB, Gen5 (Intel models only)	P73030-005
512 GB, Gen5 (Intel models only)	P73029-005
1 TB, Gen4	N77394-005
512 GB, Gen4	N77392-005
256 GB, Gen4	N77391-005

Before removing the SSD, follow these steps:

1. Prepare the computer for disassembly (see [Preparation for disassembly on page 30](#)).
2. Remove the bottom cover (see [Bottom cover on page 30](#)).
3. Remove the protective covering from the system board and disconnect the battery cable from the system board (see [Removing and reinstalling the same battery on page 33](#)).

Remove the SSD:

1. Remove the two Phillips M2.0 × 2.8 screws (1) that secure the SSD cover.
2. Pull the cover (2) off the SSD.

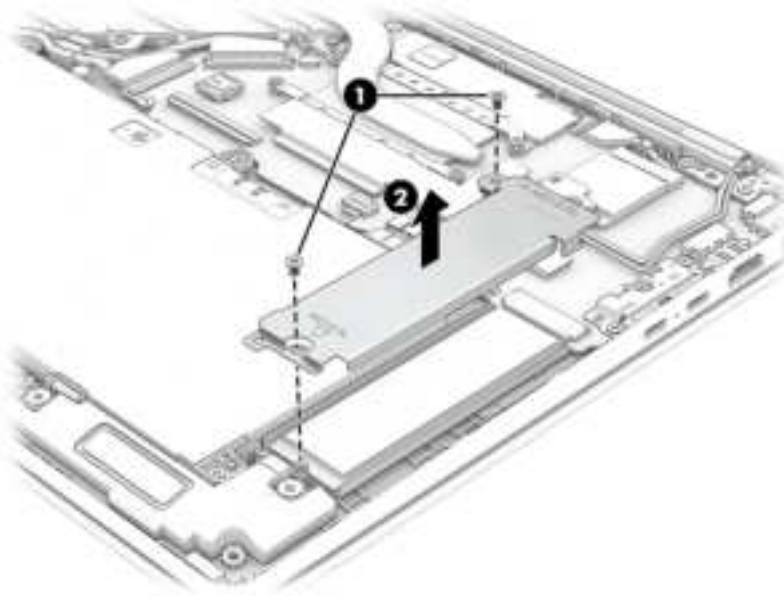

3. Pull the SSD out of the socket.

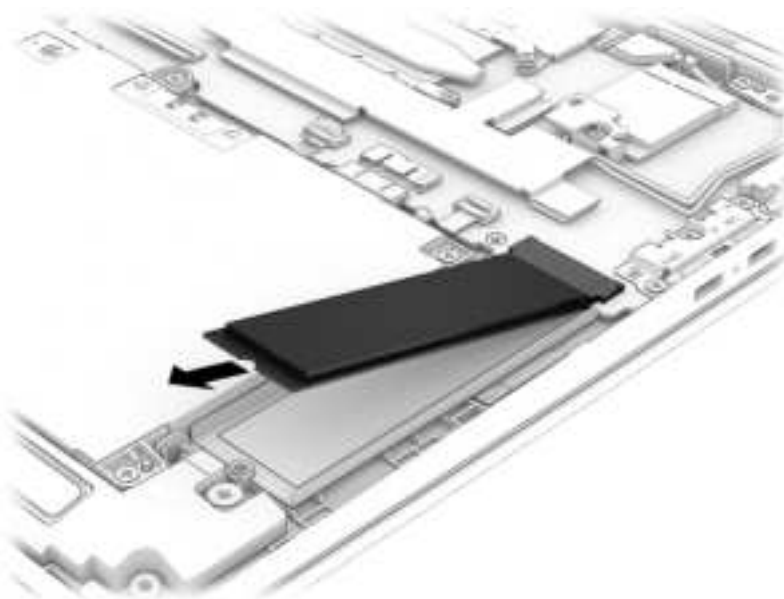

Reverse the removal procedures to install an SSD.

When installing an SSD, be sure a thermal pad is installed on the bottom of the SSD cover.

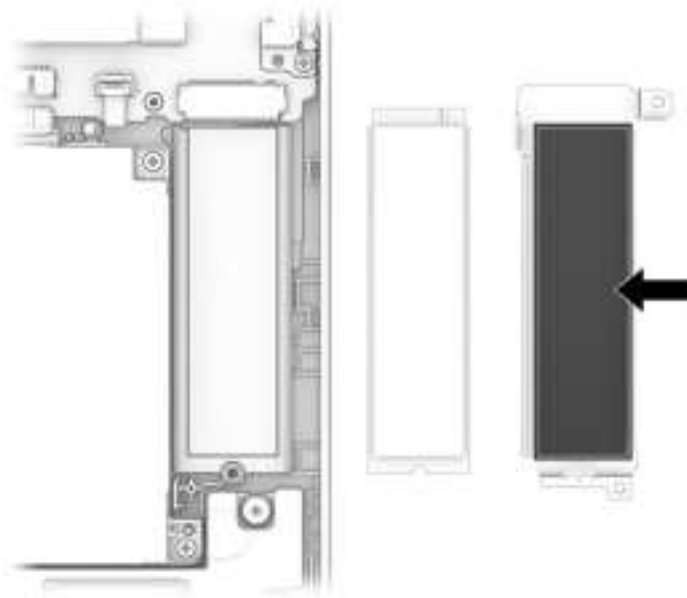

NOTE: SSDs are designed with a notch to prevent incorrect insertion.

WLAN module

Use this procedure and illustration to remove the WLAN module.

Table 6-2 WLAN module descriptions and part numbers

Description	Spare part number
WLAN module for use in models with an Intel processor	
Realtek Wi-Fi 6 RTL8852BE-VT + Bluetooth 5.4	P06350-005
Realtek Wi-Fi 7 RTL8922AE-VS + Bluetooth 6.0	P44408-005
Intel Wi-Fi 7 R2 BE211 + Bluetooth 6.0	P36621-005
WLAN module for use in models with an AMD processor	
MediaTek MT7920 Wi-Fi 6 + Bluetooth 5.4	P17386-005
Realtek Wi-Fi 7 RTL8922AE-VS + Bluetooth 6.0	P44408-005

IMPORTANT: To prevent an unresponsive system, replace the wireless module only with a wireless module authorized for use in the computer by the governmental agency that regulates wireless devices in your country or region. If you replace the module and then receive a warning message, remove the module to restore device functionality, and then contact technical support.

Before removing the WLAN module, follow these steps:

1. Prepare the computer for disassembly ([Preparation for disassembly on page 30](#)).
2. Remove the bottom cover (see [Bottom cover on page 30](#)).
3. Remove the protective covering from the system board and disconnect the battery cable from the system board (see [Removing and reinstalling the same battery on page 33](#)).

Remove the WLAN module:

1. Disconnect the antenna cables **(1)** from the module terminals.
2. Remove the Phillips M2.0 × 3.0 screw **(2)** that secures the WLAN module.
3. Remove the module **(3)** by pulling it away from the slot at an angle.

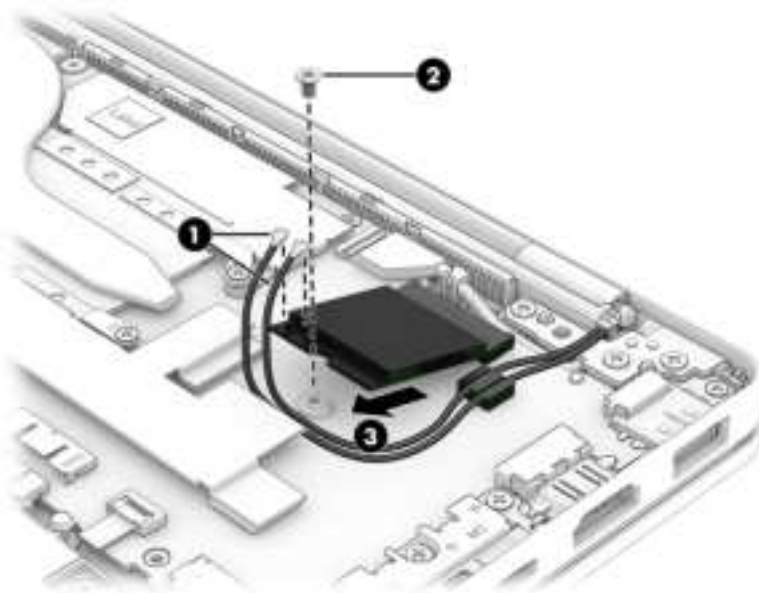

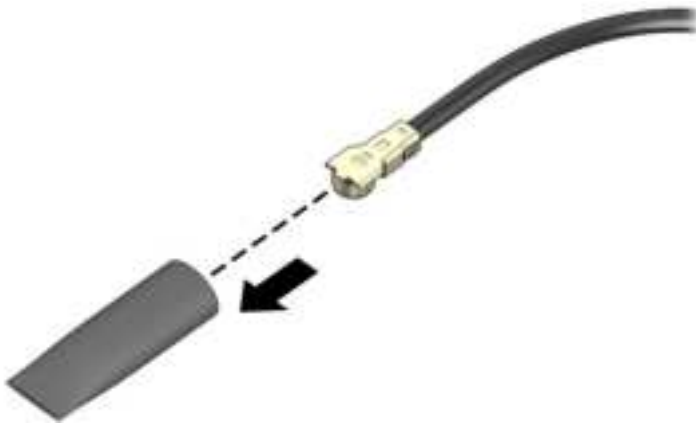

4. If the WLAN antenna is not connected to the terminal on the WLAN module, install a protective sleeve on the antenna connector, as shown in the following illustration.

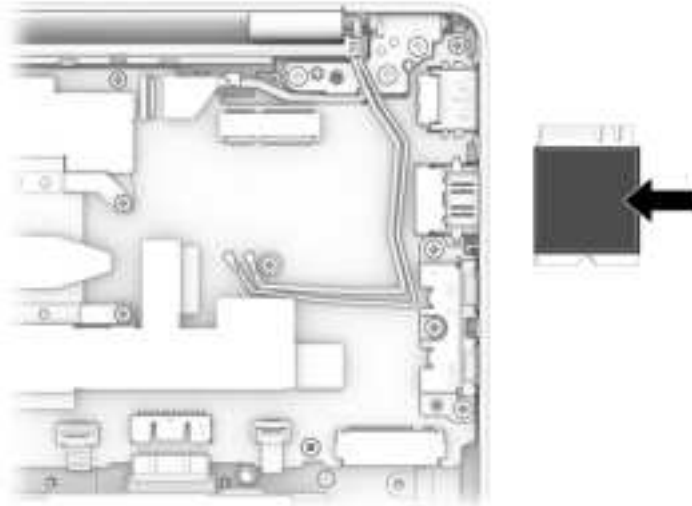

Reverse this procedure to install the WLAN module.

When installing a WLAN module, be sure a thermal pad is installed on the bottom of the module.



 **NOTE:** WLAN modules are notched to prevent incorrect installation.

Speakers

Use this procedure and illustration to remove the speakers.

Table 6-3 Speakers description and part number

Description	Spare part number
Speakers (left and right)	P84315-001

Before removing the speakers, follow these steps:

1. Prepare the computer for disassembly (see [Preparation for disassembly on page 30](#)).
2. Remove the bottom cover (see [Bottom cover on page 30](#)).
3. Remove the protective covering from the system board and disconnect the battery cable from the system board (see [Removing and reinstalling the same battery on page 33](#)).

Remove the speakers:

1. Disconnect the speaker cable **(1)** from the system board.
2. Remove the speaker cable from the clip **(2)**.
3. Remove the four Phillips M2.0 × 3.0 screws **(3)** that secure the speakers.

- Lift the speakers (4) up and then remove the speaker cable from the clips (5) between the speakers.

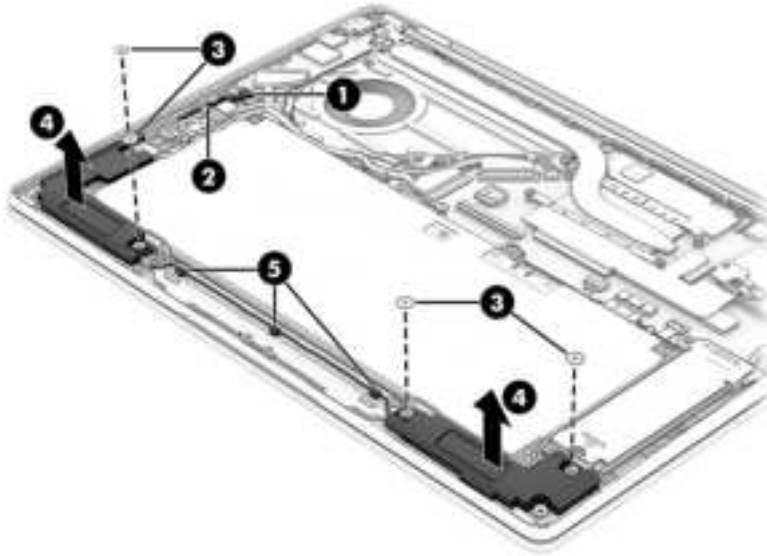

Reverse this procedure to install the speakers.

Fan

Use this procedure and illustration to remove the fan.

Table 6-4 Fan description and part number

Description	Spare part number
Fan	P83622-001

Before removing the fan, follow these steps:

- Prepare the computer for disassembly (see [Preparation for disassembly on page 30](#)).
- Remove the bottom cover (see [Bottom cover on page 30](#)).
- Remove the protective covering from the system board and disconnect the battery cable from the system board (see [Removing and reinstalling the same battery on page 33](#)).

Remove the fan:

- Disconnect the fan cable (1) from the system board.
- Remove the three Phillips M2.0 × 3.5 screws (2) from the fan.

3. Lift the fan **(3)** out of the computer.

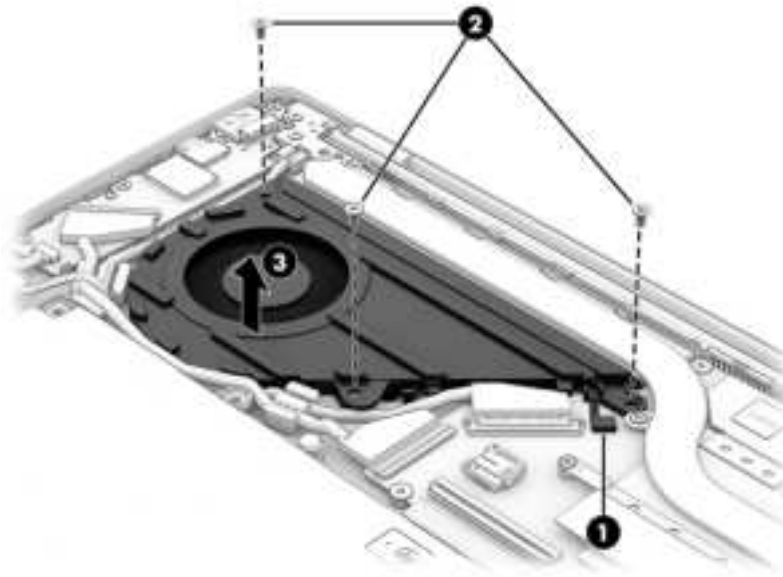

Reverse this procedure to install the fan.

Touchpad

Use this procedure and illustration to remove the touchpad.

Table 6-5 Touchpad descriptions and part numbers

Description	Spare part number
Glacier silver	P84322-001
Meteor silver	P84323-001
Sahara silver	P84324-001
Starlit blue	P84325-001

Before removing the touchpad, follow these steps:

1. Prepare the computer for disassembly (see [Preparation for disassembly on page 30](#)).
2. Remove the bottom cover (see [Bottom cover on page 30](#)).
3. Remove the protective covering from the system board and remove the battery (see [Removing and reinstalling the same battery on page 33](#)).

Remove the touchpad:

1. Remove the speaker cable from the clips **(1)** on the touchpad bracket.
2. Remove the four Phillips M1.2 × 3.0 screws **(2)** from the bracket.

3. Remove the bracket **(3)** from the computer.

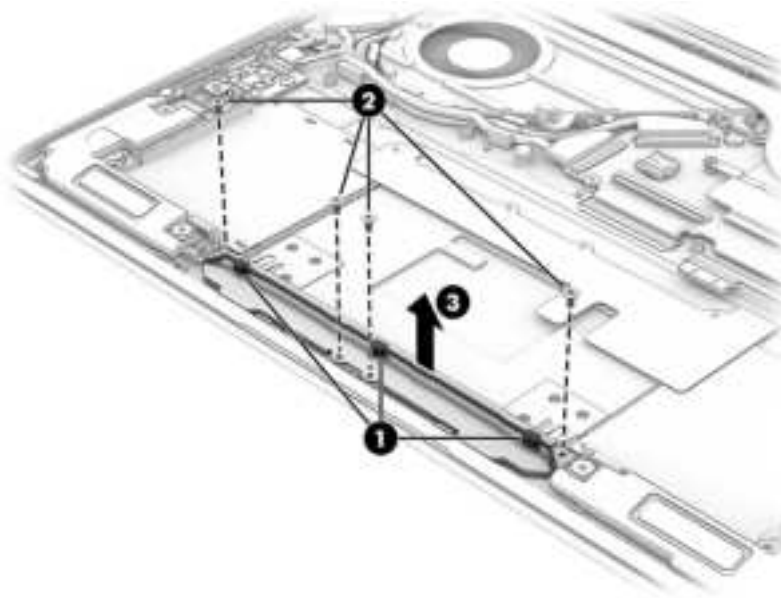

4. Remove the tape **(1)** that covers the touchpad connector.
5. Disconnect the cable from the ZIF connector **(2)** on the touchpad.
6. Lift (do not remove) the black plastic **(3)** off the top of the touchpad far enough to access the screws underneath.
7. Remove the three Phillips M1.2 × 1.2 screws **(4)** from the touchpad.
8. Remove the touchpad **(5)** from the computer.

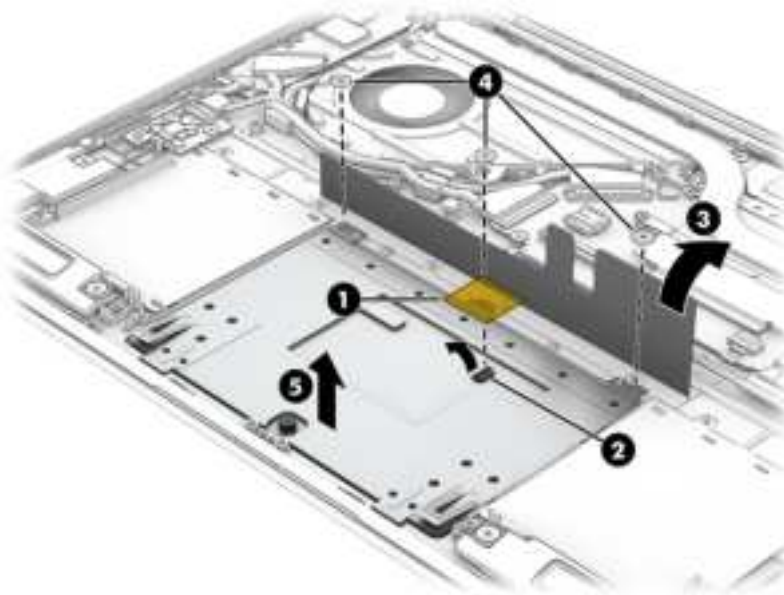

Reverse the removal procedures to install the touchpad.

I/O board

Use this procedure and illustration to remove the I/O board.

Table 6-6 I/O board description and part number

Description	Spare part number
I/O board (includes cable)	P84310-001

Before removing the I/O board, follow these steps:

1. Prepare the computer for disassembly (see [Preparation for disassembly on page 30](#)).
2. Remove the bottom cover (see [Bottom cover on page 30](#)).
3. Remove the protective covering from the system board and disconnect the battery cable from the system board (see [Removing and reinstalling the same battery on page 33](#)).

Remove the I/O board:

1. Disconnect the system board cable from the ZIF connector **(1)** on the I/O board.
2. Disconnect the speaker cable from the connector **(2)** on the I/O board.
3. Remove the two Phillips 2.0 × 2.8 screws **(3)** from the board.
4. Remove the board **(4)** from the computer.

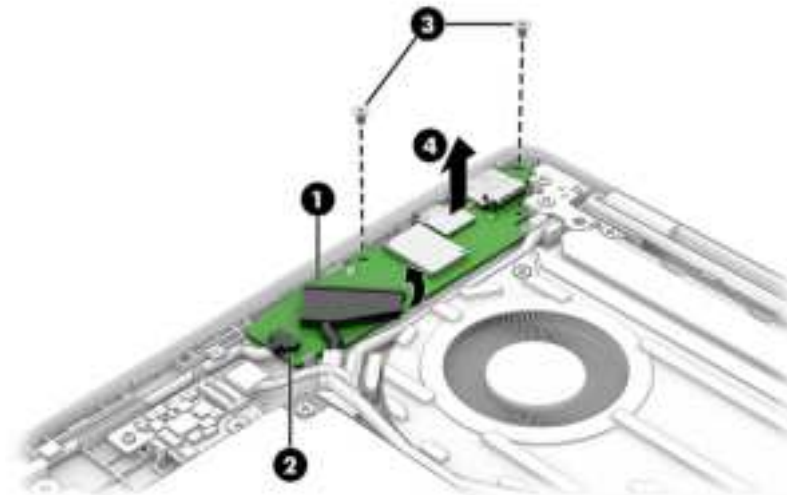

Reverse this procedure to install the I/O board.

OLED board

Use this procedure and illustration to remove the OLED board.

Table 6-7 OLED board description and part number

Description	Spare part number
OLED PMIC board (includes cable)	P83616-001

Before removing the OLED board, follow these steps:

1. Prepare the computer for disassembly (see [Preparation for disassembly on page 30](#)).
2. Remove the bottom cover (see [Bottom cover on page 30](#)).
3. Remove the protective covering from the system board and disconnect the battery cable from the system board (see [Removing and reinstalling the same battery on page 33](#)).

Remove the OLED board:

1. Disconnect the display cable from the ZIF connector **(1)** on the OLED board.
2. Remove the Phillips 2.0 × 2.0 screw **(2)** from the board.
3. Remove the board **(3)** from the computer.

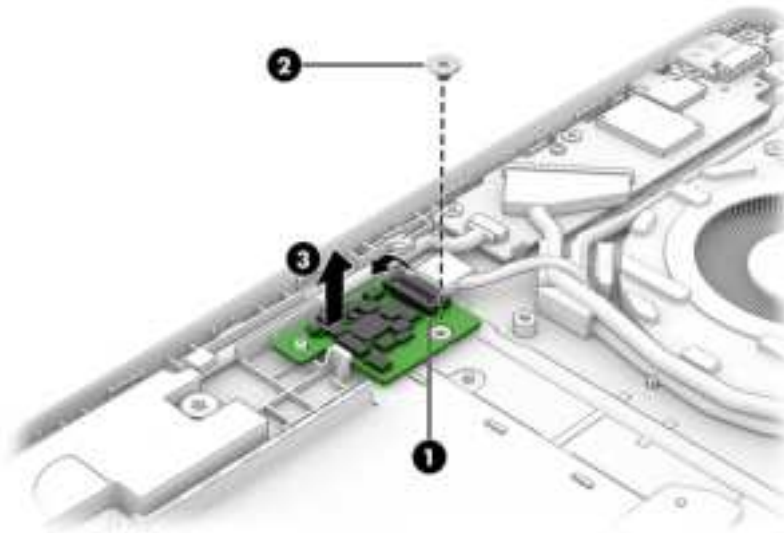

Reverse this procedure to install the OLED board.

System board

Use these procedures and illustrations to remove the system board.

Table 6-8 System board descriptions and part numbers

Description	Spare part number
System board for use in models with an Intel processor	
Intel Core 7 150U processor and 16 GB system memory	P82019-601
Intel Core 7 150U processor and 16 GB system memory (PRC)	P82020-601
Intel Core 5 120U processor and 16 GB system memory	P82017-601
Intel Core 5 120U processor and 16 GB system memory (PRC)	P82018-601
Intel Core Ultra 5 H204 and 16 GB system memory	P82021-601
Intel Core Ultra 7 404 and 16 GB system memory	P82022-601
Intel Core Ultra 7 404 and 32 GB system memory	P82023-601

Table 6-8 System board descriptions and part numbers (continued)

Description	Spare part number
Intel Core Ultra 9 484 and 32 GB system memory	P82024-601
Intel Core Ultra 9 484 and 32 GB system memory (PRC)	P82025-601
PTL U SH 444 and 16 GB system memory (PRC)	P82026-601
PTL U SH 444 and 32 GB system memory (PRC)	P82027-601
System board for use in models with an AMD processor	
AMD Ryzen AI 9 H 465 processor and 32 GB system memory (PRC)	P82041-601
AMD Ryzen AI 9 465 processor and 32 GB system memory	P82040-601
AMD Ryzen AI 7 445 processor and 32 GB system memory (PRC)	P82038-601
AMD Ryzen AI 7 445 processor and 16 GB system memory	P82036-601
AMD Ryzen AI 7 H 445 processor and 32 GB system memory (PRC)	P82039-601
AMD Ryzen AI 7 H 445 processor and 16 GB system memory (PRC)	P82037-601
AMD Ryzen AI 5 430 processor and 16 GB system memory	P82034-601
AMD Ryzen AI 5 H 430 processor and 16 GB system memory (PRC)	P82035-601
AMD Ryzen AI 5 330 processor and 32 GB system memory	Q05080-601
AMD Ryzen AI 5 330 processor and 32 GB system memory (PRC)	Q05082-601
AMD Ryzen AI 5 330 processor and 16 GB system memory	Q05079-601
AMD Ryzen AI 5 330 processor and 16 GB system memory (PRC)	Q05081-601
AMD Ryzen 7 250 processor and 32 GB system memory	P82044-601
AMD Ryzen 7 250 processor and 32 GB system memory (PRC)	P82045-601
AMD Ryzen 7 250 processor and 16 GB system memory	P82042-601
AMD Ryzen 7 250 processor and 16 GB system memory (PRC)	P82043-601
AMD Ryzen 5 230 processor and 16 GB system memory	P82046-601
AMD Ryzen 5 230 processor and 16 GB system memory (PRC)	P82047-601

Before removing the system board, follow these steps:

1. Prepare the computer for disassembly (see [Preparation for disassembly on page 30](#)).
2. Remove the bottom cover (see [Bottom cover on page 30](#)).
3. Remove the protective covering from the system board and disconnect the battery cable from the system board (see [Removing and reinstalling the same battery on page 33](#)).
4. Remove the SSD (see [Solid-state drive on page 41](#)).
5. Remove the WLAN module (see [WLAN module on page 43](#)).
6. Remove the fan (see [Fan on page 46](#)).

Remove the system board:

1. Disconnect the following cables from the system board:
 - I/O board cable (ZIF) **(1)**
 - Display cable with OLED cable (ZIF) **(2)**
 - Fan cable **(3)**
 - Camera cable (ZIF) **(4)**
 - Touchpad cable (ZIF) **(5)**
 - Keyboard backlight cable (ZIF) **(6)**
 - Keyboard cable (ZIF) **(7)**

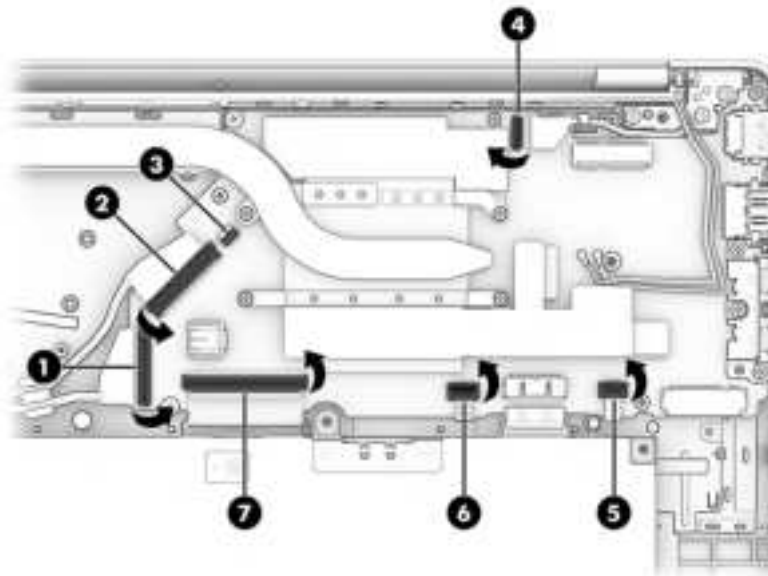

2. Remove the three Phillips M2.0 × 3.0 screws **(1)** from the top of the system board.
3. Remove the Phillips M2.0 × 2.0 screw **(2)** from the bottom left of the system board.

4. Remove the three Phillips M2.0 × 2.8 screws (3) from the bracket on the right side of the system board.

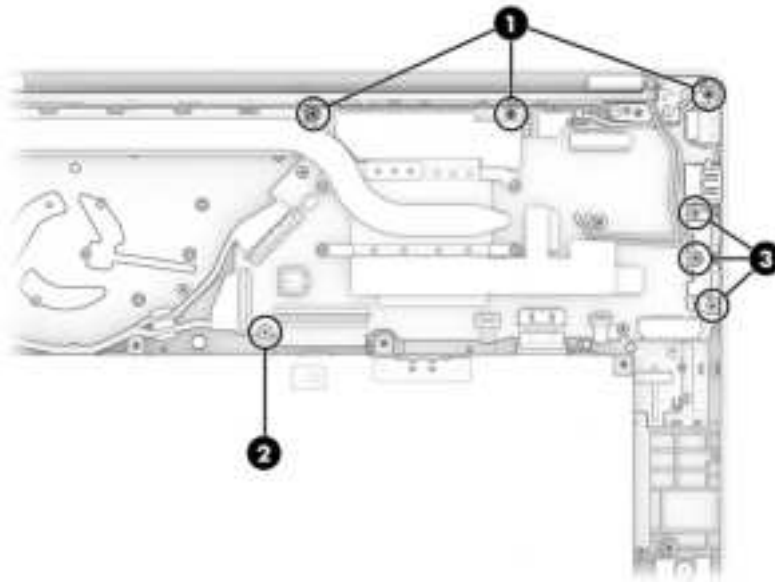

5. Lift the left side of the board (1) and pull the board (2) to the left and up to remove it from computer.

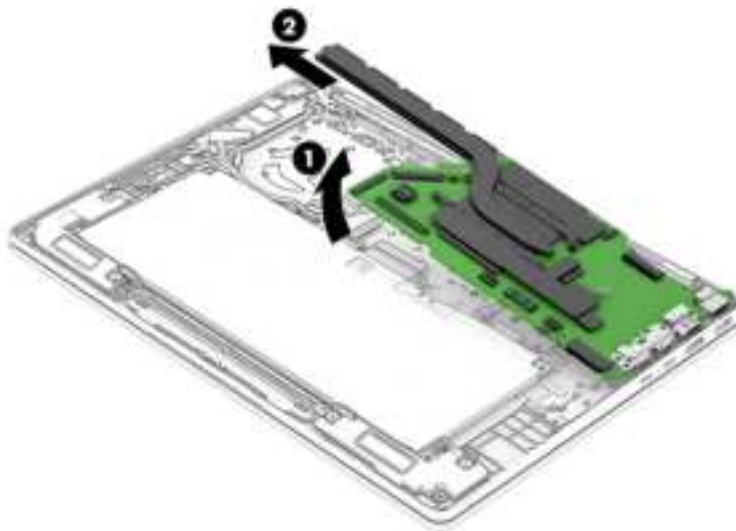

- When replacing the system board, be sure to remove the USB bracket from the old board and install it onto the new board. To remove the bracket, rotate the inside of the bracket **(1)** up, and then pull the bracket **(2)** off the system board.

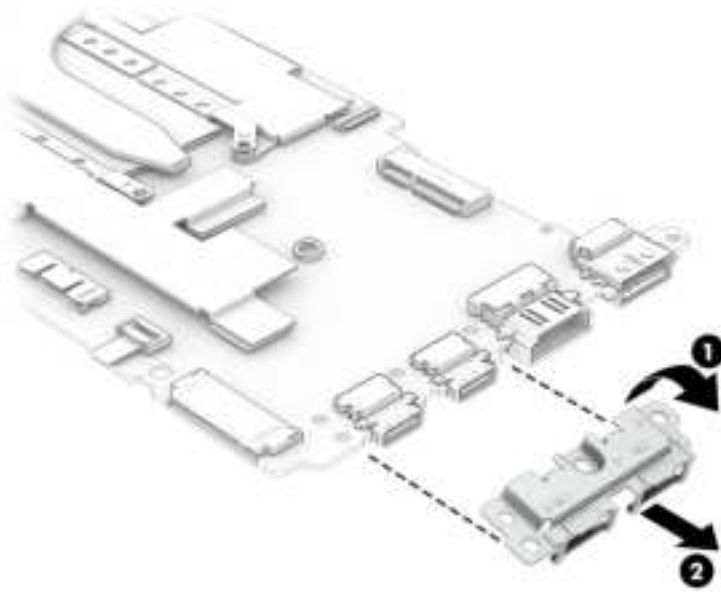

Reverse this procedure to install a system board.

Heat sink

Use these procedures and illustrations to remove the heat sink.

Table 6-9 Heat sink descriptions and part numbers

Description	Spare part number
Heat sink (Intel Core processors)	P84316-001
Heat sink (Intel Core Ultra processors)	P84317-001
Heat sink (AMD Ryzen 7 and Ryzen 5 processors)	P84319-001
Heat sink (AMD Ryzen AI 9 and AI 7 processors)	P84320-001
Heat sink (AMD Ryzen AI 5 processors)	P84321-001
Heat sink (AMD Ryzen AI 5 330 processor)	Q06613-001

Before removing the heat sink, follow these steps:

- Prepare the computer for disassembly (see [Preparation for disassembly on page 30](#)).
- Remove the bottom cover (see [Bottom cover on page 30](#)).
- Remove the protective covering from the system board and disconnect the battery cable from the system board (see [Removing and reinstalling the same battery on page 33](#)).

Remove the heat sink:

- In the order shown on the heat sink, remove the four Phillips M2.0 × 2.5 screws **(1)** from the heat sink.

2. Remove the heat sink (2).

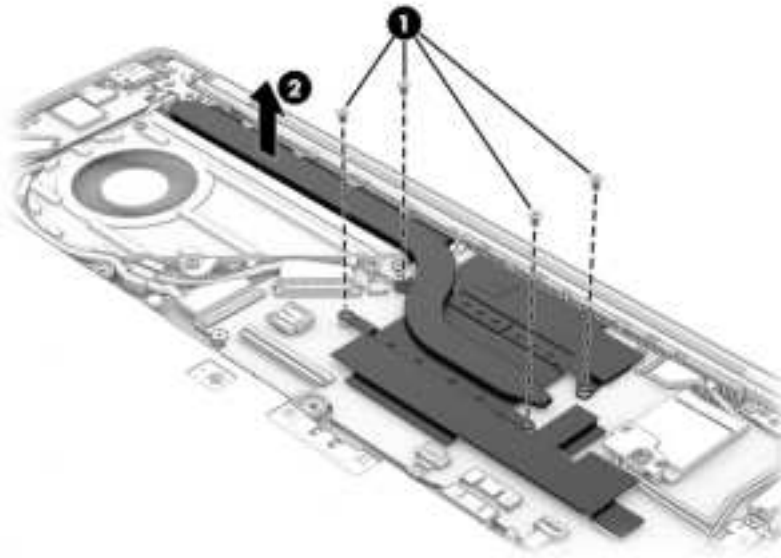

3. Each time the heat sink is removed, thoroughly clean and replace the gray thermal grease (1) and thermal pads (2) from the surface of the heat sink. Remember to reapply thermal material on the heat sink instead of the system board. Thoroughly clean the gray thermal grease from system boards that you plan to recycle, because the gray grease will no longer be in a sealed space.

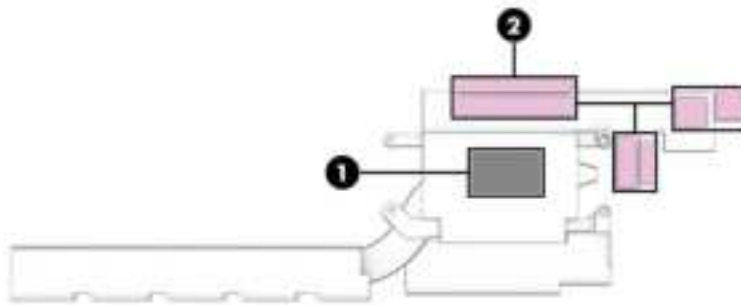

Use the following process to clean and apply thermal material on the heat sink:

- a. Use alcohol wipes to completely remove the thermal grease from the heat sink.

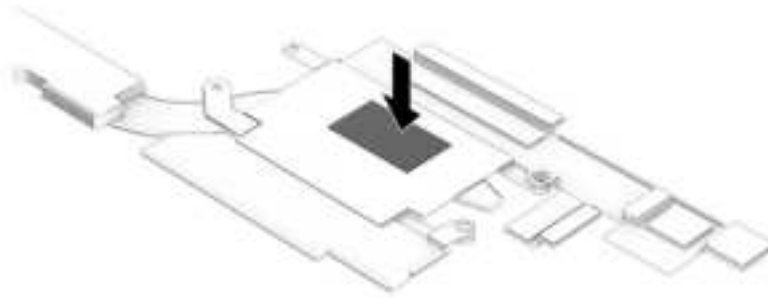

- b. Place tape around the marked boundary lines to be sure you apply the grease in the correct size and thickness.

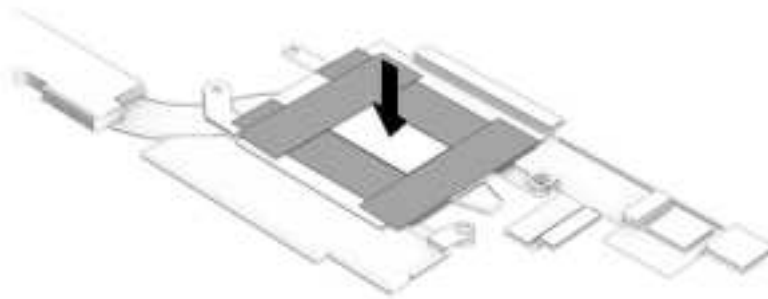

- c. Apply the thermal grease (PTM-7958-SP) using a scraper or blade to ensure uniform coverage. Be sure to apply the thermal grease evenly with a thickness of at least 0.2 mm to ensure proper thermal efficiency.

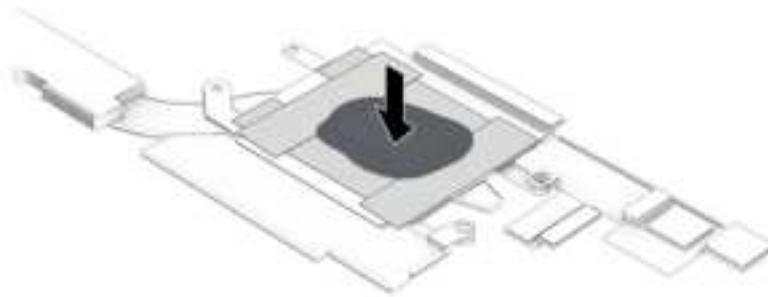

- d. Remove the tape from the heat sink.

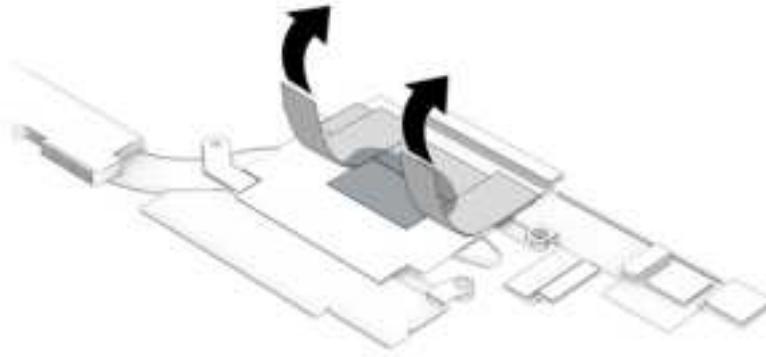

- e. Check the thermal pads and replace it if contaminated or damaged.

Reverse this procedure to install the heat sink.

Display assembly

Use these procedures and illustrations to remove and disassemble the display assembly.

 **NOTE:** The display assembly is only available as spare parts at the subcomponent level. For display assembly spare part information, see [Display assembly subcomponents on page 18](#).

Before removing the display panel, follow these steps:

1. Prepare the computer for disassembly (see [Preparation for disassembly on page 30](#)).
2. Remove the bottom cover (see [Bottom cover on page 30](#)).
3. Remove the protective covering from the system board and disconnect the battery cable from the system board (see [Removing and reinstalling the same battery on page 33](#)).

Remove the display assembly:

1. Disconnect the OLED power board cable from the ZIF connector **(1)** on the OLED board.
2. Disconnect the display cable from the ZIF connector **(2)** on the system board.

3. Remove the display/OLED power cable from the routing clips **(3)** around the fan.

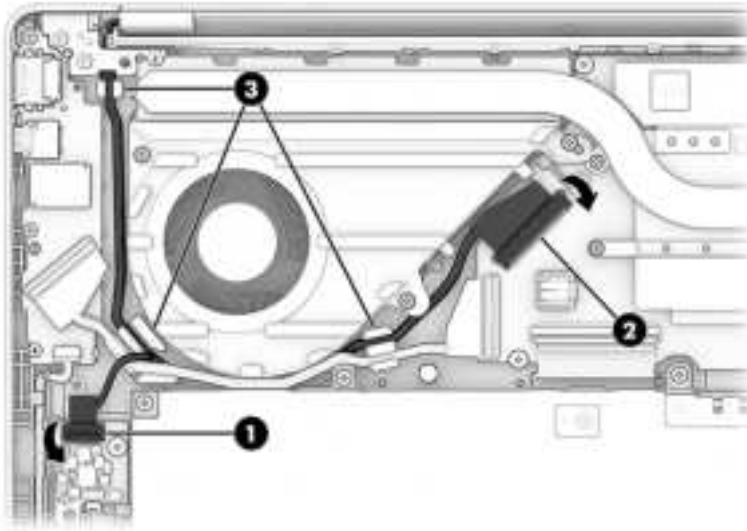

4. Disconnect the camera cable from the ZIF connector **(1)** on the system board.
5. Remove the camera cable from the clip **(2)**.
6. Disconnect the antenna cables **(3)** from the WLAN module.
7. Remove the antenna cables from the clip **(4)** that secures them to the system board.

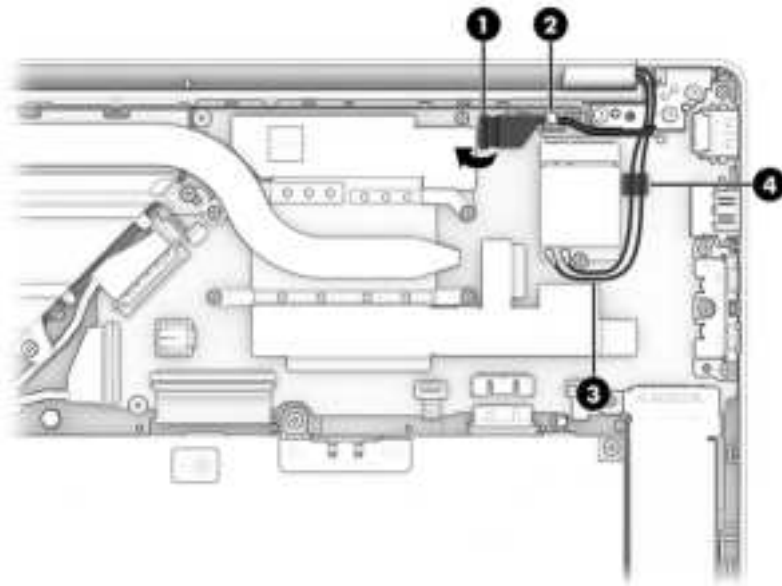

8. Open the display (1) and place the computer (2) keyboard-side down with the display hanging down off the side of a table.

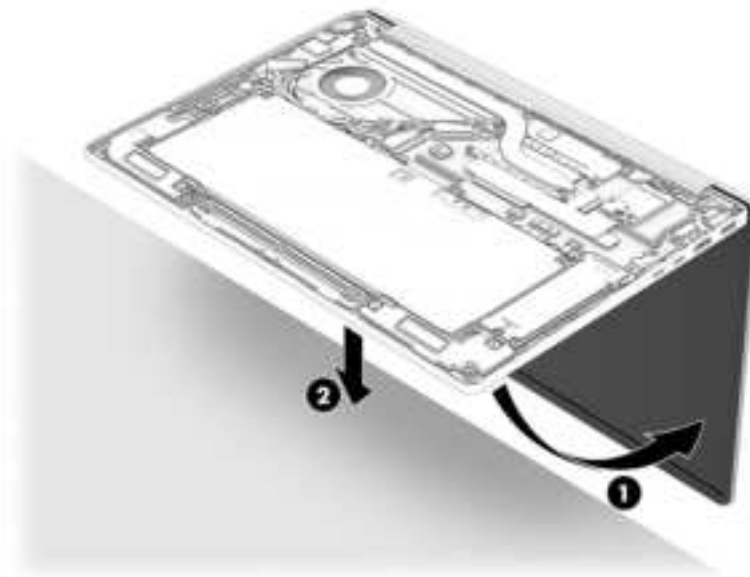

9. Remove the six Phillips M2.5 × 3.7 screws that secure the display assembly to the computer.

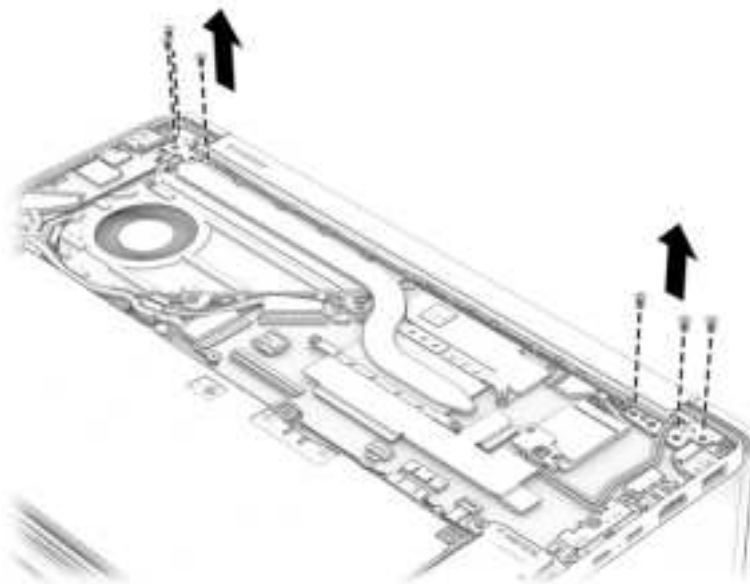

10. Separate the display from the computer.

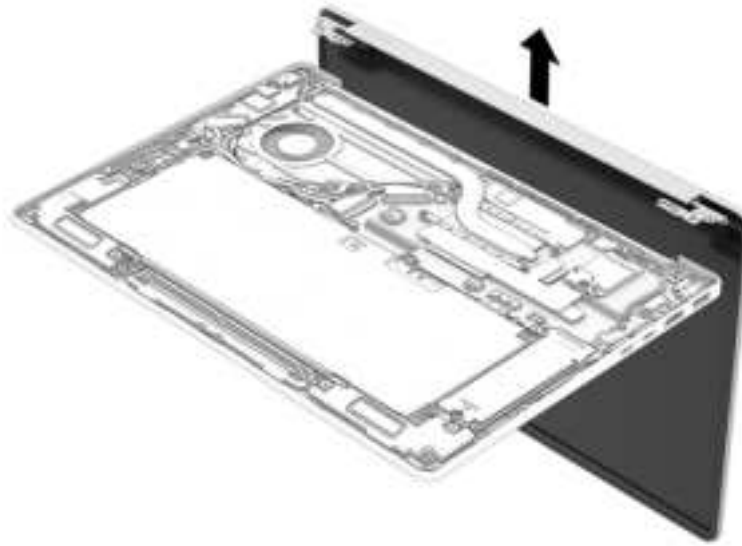

11. To remove the display bezel:

- a. Hold a heat gun 10 cm (2.5 in) above the display. Point the gun at each edge of the panel for 10 - 20 seconds to loosen the adhesive. Heat the panel to approximately 150°.

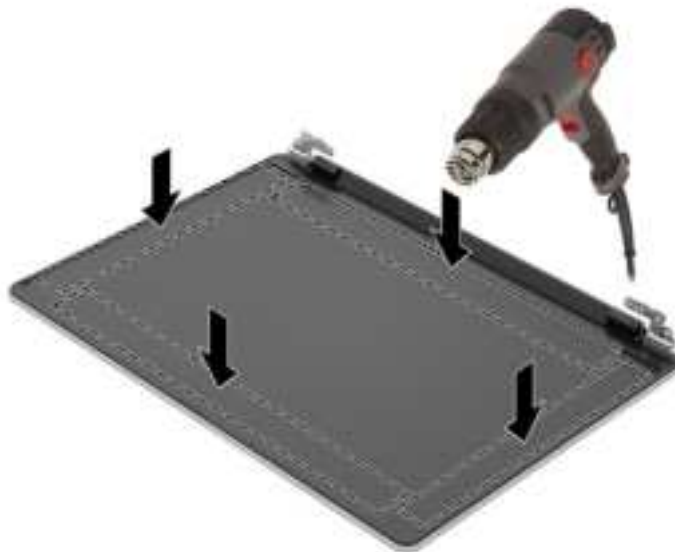

- b. From the outside of the bezel, release the bezel from the top **(1)** and left and right sides **(2)** of the display.
- c. Release the bezel **(3)** from the bottom of the display.

- d. Remove the bezel (4).

 **IMPORTANT:** To avoid damage to the panel, do not use a tool on the inside of the bezel. You can use a tool only when you insert it from the outside of the top, left, and right sides of the bezel. Use your fingers to lift up on the bezel. Avoid pressing down on the panel during removal.

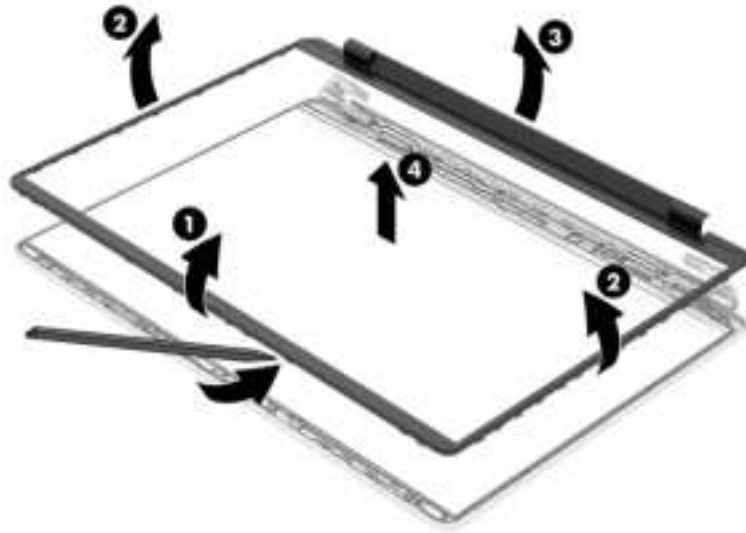

- 12. To remove the display panel:

- a. Use tweezers to grasp the stretchable adhesive tape (1) on the left and right sides of the panel.
- b. While wrapping the tape (2) around the tweezers, pull the tape (3) out from behind the panel.

 **NOTE:** Slowly pull the tape so you are careful not to break it.

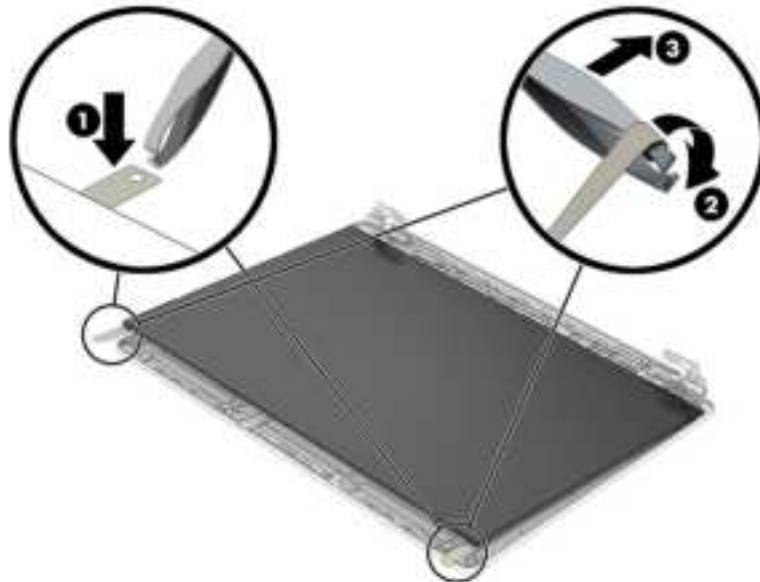

- c. Lift the panel off the display rear cover.

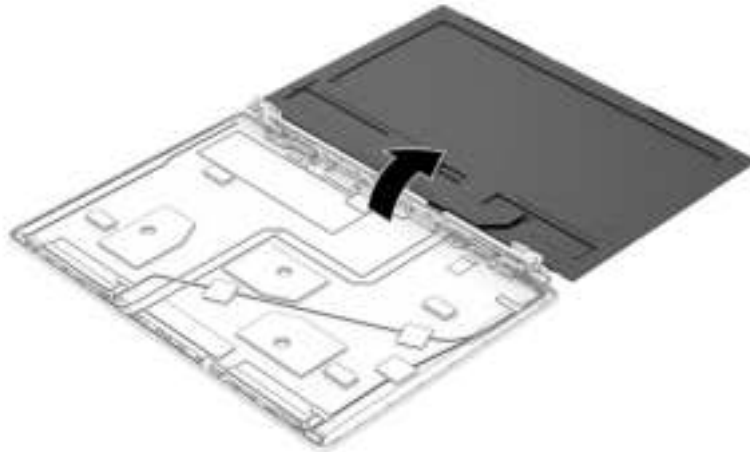

- d. When installing a display panel, use the following illustration to determine tape installation locations on the inside of the display rear cover.

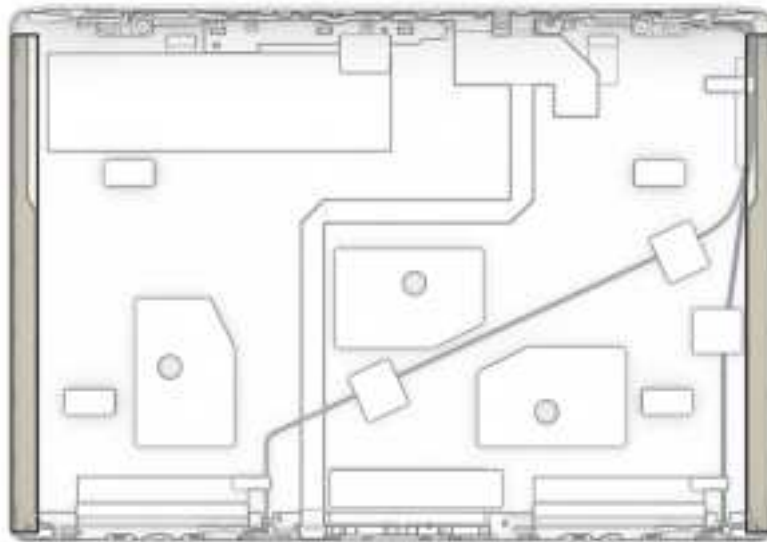

- 13. To remove the display cable:

- a. Peel the conductive tape (1) off the connector on the bottom of the panel.

- b. Open the locking bar (2), and then disconnect the cable (3) from the panel.

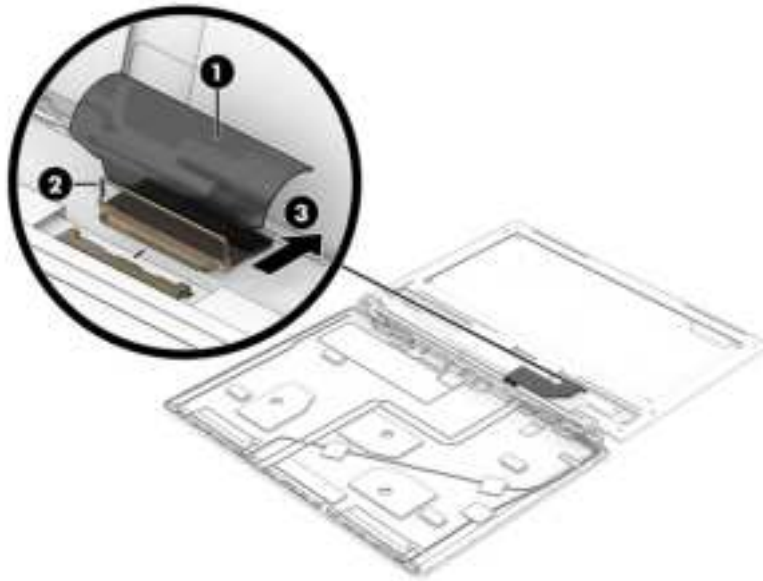

14. To remove the camera module:

- a. At the location shown in the following illustration, insert a pry tool (1) under the camera module, and then pull the tool across the length of the module (2) to release it.
- b. Position the module (3) upside down, and then disconnect the cable from the reverse ZIF connector (4) on the camera module.

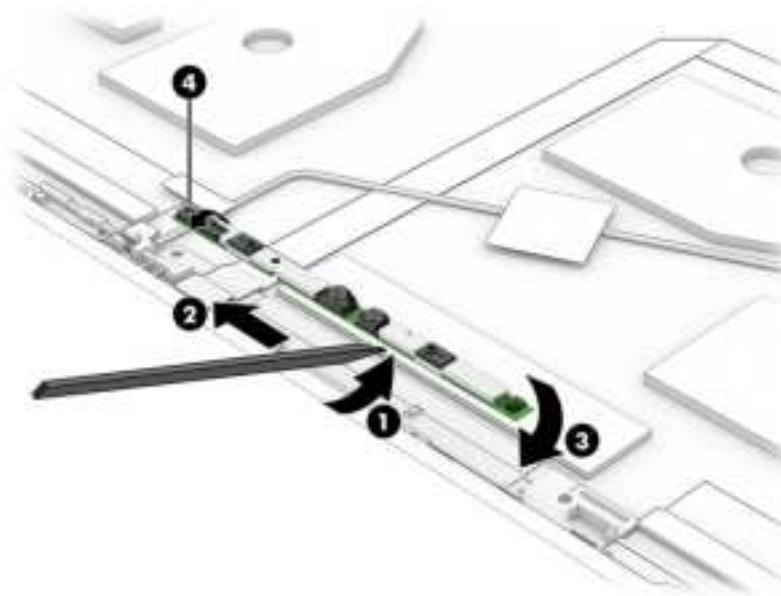

15. To remove the hinges from the display rear cover:

- a. Remove the two Phillips M2.0 × 2.0 screws (1) from each hinge.
- b. Remove the three Phillips M2.0 × 2.5 screws (2) from each hinge.

- c. Remove the hinges (3) from the display back cover.

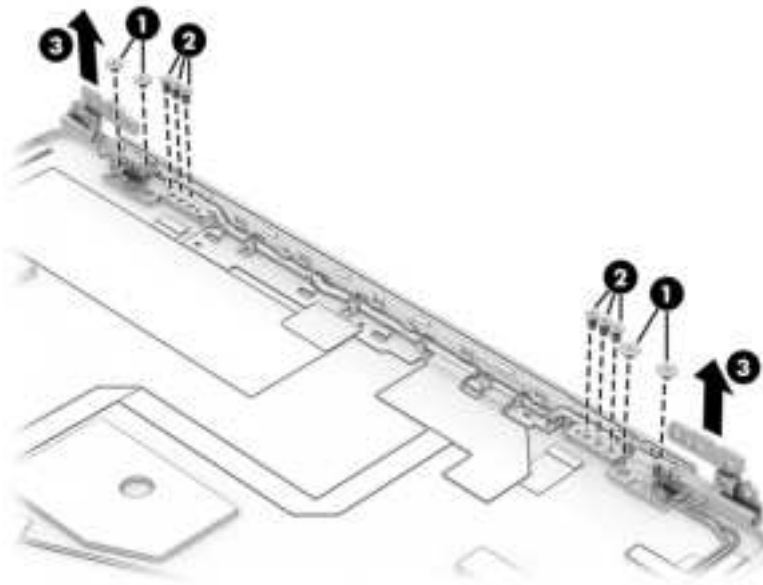

- 16. To remove the camera cable:

- a. Remove the cable (1) from the hinge.
- b. Peel the cable (2) off the inside of the display rear cover.
- c. Pull the cable (3) out from under the antenna cable.

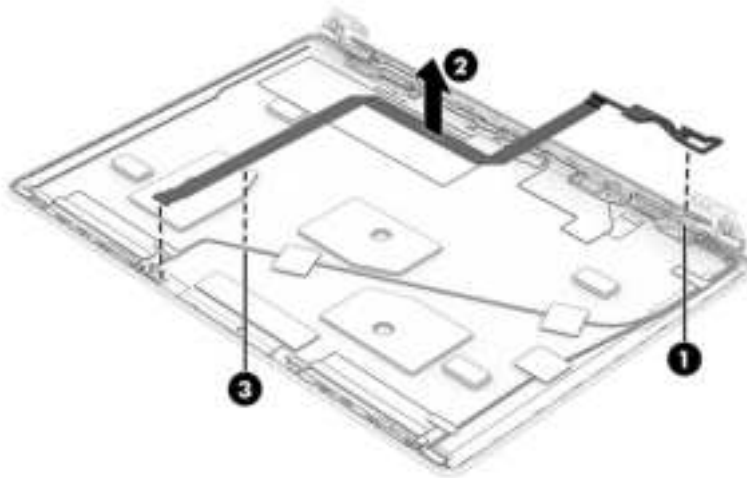

- 17. To remove the wireless antennas and cables:

- a. Remove the antenna cables from the clips (1) along the sides of the display rear cover.
- b. Remove the cables from the tape (2) near the bottom of the inside of the display rear cover.
- c. Remove the cables from the tape (3) on the inside of the display rear cover.

- d. Peel the antennas (4) off the display rear cover.

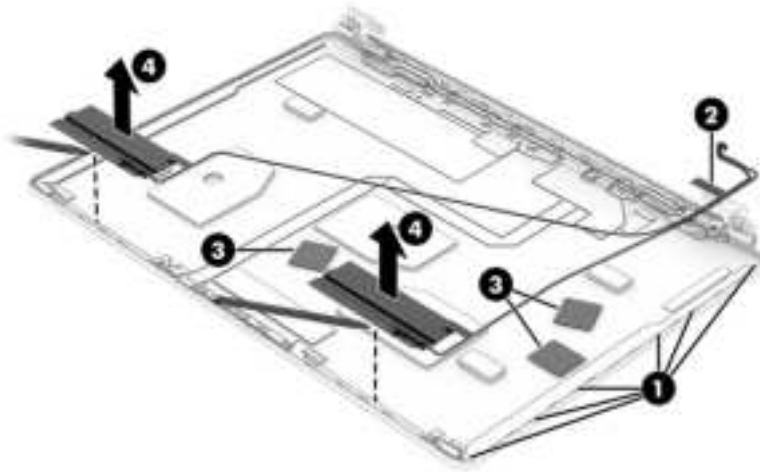

- 18. To remove the touch board (select products only):

- a. Disconnect the cables from the two ZIF connectors (1) on the middle of the board.
- b. Disconnect the cable from the ZIF connector (2) on the end of the board.
- c. Use a tool (3) to lift the inside of the board up.
- d. Peel the tape (4) off the board.
- e. Remove the board (5) from the display.

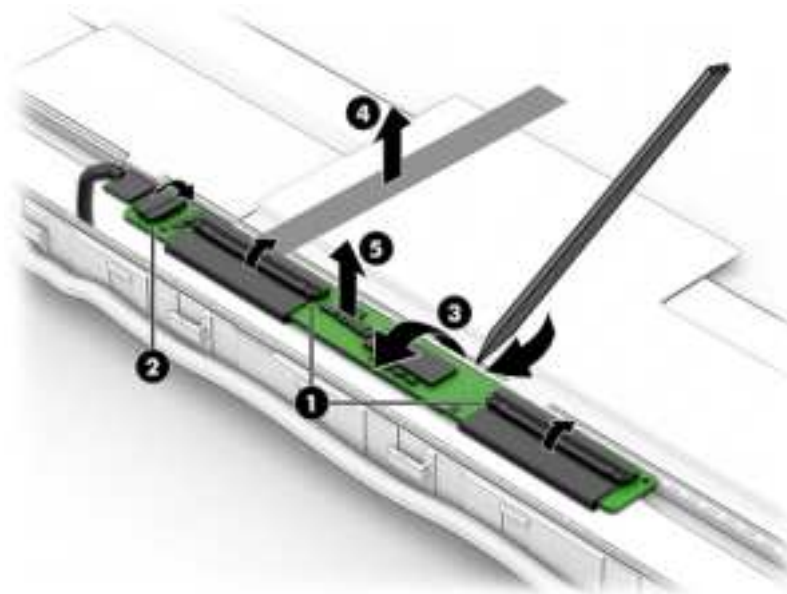

- f. When installing a touch board, be sure to install the tape from the board into the display panel.

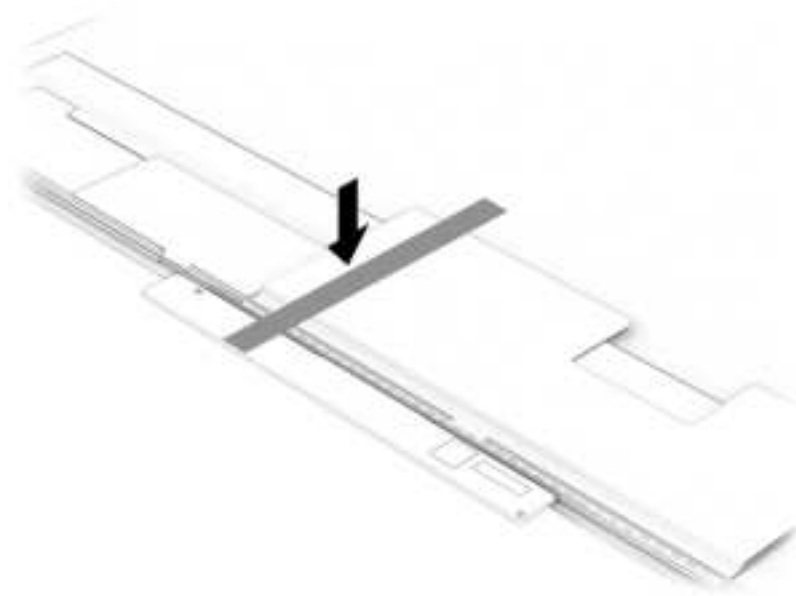

Reverse these procedures to reassemble and replace the display assembly.

Top cover with keyboard

The top cover remains after removing all other spare parts from the computer. The first table includes the top cover spare part numbers. The second table includes keyboard country codes.

Table 6-10 Top cover with keyboard descriptions and part numbers

Description	Spare part number
Canvas gray	P82013-xx1
Darker meteor silver	P82014-xx1
Darker sahara silver	P82015-xx1
Darker starlit blue	P82016-xx1

Table 6-11 Spare part country codes

For use in country or region	Spare part number
Belgium	-A41
Czech Republic/Slovakia	-FL1
Denmark, Finland, and Norway	-DH1
French Canada	-DB1
France	-051
Germany	-041
Greece	-151
Israel	-BB1

Table 6-11 Spare part country codes (continued)

For use in country or region	Spare part number
Italy	-061
Japan	-291
Latin America	-161
The Netherlands	-B31
Russia	-251
Saudi Arabia	-171
Slovenia	-BA1
South Korea	-AD1
Spain	-071
Switzerland	-BG1
Taiwan	-AB1
Thailand	-281
Turkey	-141
Ukraine	-BD1
United Kingdom	-031
United States	-001

7 Using Setup Utility (BIOS)

Setup Utility, or Basic Input/Output System (BIOS), controls communication between all the input and output devices on the system (such as disk drives, display, keyboard, mouse, and printer). Setup Utility (BIOS) includes settings for the types of devices installed, the startup sequence of the computer, and the amount of system and extended memory.

 **NOTE:** To start Setup Utility on convertible computers, your computer must be in notebook mode and you must use the keyboard attached to your notebook.

Starting Setup Utility (BIOS)

You have several ways to access the Setup Utility (BIOS).

 **IMPORTANT:** Use extreme care when making changes in Setup Utility (BIOS). Errors can prevent the computer from operating properly.

Use one of these options:

- Turn on or restart the computer and quickly press **f10**.
- Turn on or restart the computer, quickly press **esc**, and then press **f10** when the Start menu is displayed.

Updating Setup Utility (BIOS)

Updated versions of Setup Utility (BIOS) might be available on the HP website. Most BIOS updates on the HP website are packaged in compressed files called *SoftPaqs*. Some download packages contain a file named `Readme.txt`, which contains information regarding installing and troubleshooting the file.

Determining the BIOS version

To decide whether you need to update Setup Utility (BIOS), first determine the BIOS version on your computer.

To reveal the BIOS version information (also known as *ROM date* and *System BIOS*), use one of these options.

- HP Support Assistant
 1. Perform one of these tasks:
 - Select the **Search** icon in the taskbar, type `support` in the search box, and then select the **HP Support Assistant** app.
 - Select the question mark icon in the taskbar.
 2. Under **My notebook**, select **Specifications**.
- Setup Utility (BIOS)

1. Start Setup Utility (BIOS) (see [Starting Setup Utility \(BIOS\) on page 68](#)).
 2. Select **Main**, and then make note of the BIOS version.
 3. Select **Exit**, select one of the options, and then follow the on-screen instructions.
- In Windows, press **ctrl+alt+s**.

To check for later BIOS versions, see [Preparing for a BIOS update on page 69](#).

Preparing for a BIOS update

Be sure to follow all prerequisites before downloading and installing a BIOS update.

 **IMPORTANT:** To reduce the risk of damage to the computer or an unsuccessful installation, download and install a BIOS update only when the computer is connected to reliable external power using the HP AC adapter provided with the computer (select products only), a replacement AC adapter provided by HP, or an AC adapter with the power rating specified on the product label. Do not download or install a BIOS update while the computer is running on battery power, docked in an optional docking device, or connected to an optional power source. During the download and installation, follow these instructions:

- Do not disconnect power from the computer by unplugging the power cord from the AC outlet.
- Do not shut down the computer or initiate Sleep.
- Do not insert, remove, connect, or disconnect any device, cable, or cord.

 **NOTE:** If your computer is connected to a network, consult the network administrator before installing any software updates, especially system BIOS updates.

Downloading a BIOS update

After you review the prerequisites, you can check for and download BIOS updates.

1. Perform one of these tasks:
 - Select the **Search** icon in the taskbar, type `support` in the search box, and then select the **HP Support Assistant** app.
 - Select the question mark icon in the taskbar.
2. Select **Updates**. The **Checking for Updates** window opens, and Windows checks for updates.
3. Follow the on-screen instructions.
4. At the download area, follow these steps:
 - a. Identify the most recent BIOS update and compare it to the BIOS version currently installed on your computer. If the update is more recent than your BIOS version, make a note of the date, name, or other identifier. You might need this information to locate the update later, after it has been downloaded to your hard drive.
 - b. Follow the on-screen instructions to download your selection to the hard drive.

Make a note of the path to the location on your hard drive where the BIOS update is downloaded. You will need to access this path when you are ready to install the update.

Installing a BIOS update

BIOS installation procedures vary. Follow any instructions that appear on the screen after the download is complete. If no instructions appear, follow these steps.

1. Select the **Search** icon in the taskbar, type `file` in the search box, and then select **File Explorer**.
2. Select your hard drive designation. The hard drive designation is typically Local Disk (C:).
3. Using the hard drive path you recorded earlier, open the folder that contains the update.
4. Double-click the file that has an .exe extension (for example, *filename.exe*).

The BIOS installation begins.

5. Complete the installation by following the on-screen instructions.

 **NOTE:** After a message on the screen reports a successful installation, you can delete the downloaded file from your hard drive.

8 Using HP PC Hardware Diagnostics

You can use the HP PC Hardware Diagnostics utility to determine whether your computer hardware is running properly. The three versions are HP PC Hardware Diagnostics Windows, HP PC Hardware Diagnostics UEFI (Unified Extensible Firmware Interface), and (for select products only) Remote HP PC Hardware Diagnostics UEFI, a firmware feature.

Using HP PC Hardware Diagnostics Windows (select products only)

HP PC Hardware Diagnostics Windows is a Windows-based utility that allows you to run diagnostic tests to determine whether the computer hardware is functioning properly. The tool runs within the Windows operating system to diagnose hardware failures.

If HP PC Hardware Diagnostics Windows is not installed on your computer, you must download and install it. To download HP PC Hardware Diagnostics Windows, see [Downloading HP PC Hardware Diagnostics Windows on page 72](#).

Using an HP PC Hardware Diagnostics Windows hardware failure ID code

When HP PC Hardware Diagnostics Windows detects a failure that requires hardware replacement, a 24-digit failure ID code is generated for select component tests. For interactive tests, such as keyboard, mouse, or audio and video palette, you must perform troubleshooting steps before you can receive a failure ID.

You have several options after you receive a failure ID:

- Select **Next** to open the Event Automation Service (EAS) page, where you can log the case.
- Scan the QR code with your mobile device, which takes you to the EAS page, where you can log the case.
- Select the box next to the 24-digit failure ID to copy your failure code and send it to support.

Accessing HP PC Hardware Diagnostics Windows

After HP PC Hardware Diagnostics Windows is installed, you can access it from HP Support Assistant or the Start menu.

Accessing HP PC Hardware Diagnostics Windows from HP Support Assistant (select products only)

After HP PC Hardware Diagnostics Windows is installed, follow these steps to access it from HP Support Assistant.

1. Complete one of the following tasks:
 - Select the **Search** icon in the taskbar, type `support` in the search box, and then select the **HP Support Assistant** app.
 - Select the question mark icon in the taskbar.

2. Select **Fixes & Diagnostics**.
3. Select **Run hardware diagnostics**, and then select **Launch**.
4. When the tool opens, select the type of diagnostic test that you want to run, and then follow the on-screen instructions.

 **NOTE:** To stop a diagnostic test, select **Cancel**.

Accessing HP PC Hardware Diagnostics Windows from the Start menu (select products only)

After HP PC Hardware Diagnostics Windows is installed, follow these steps to access it from the Start menu.

1. Select the **Start** button, and then select **All apps**.
2. Select **HP PC Hardware Diagnostics Windows**.
3. When the tool opens, select the type of diagnostic test that you want to run, and then follow the on-screen instructions.

 **NOTE:** To stop a diagnostic test, select **Cancel**.

Downloading HP PC Hardware Diagnostics Windows

The HP PC Hardware Diagnostics Windows downloading instructions are provided in English only. You must use a Windows computer to download this tool because only .exe files are provided.

Downloading the latest HP PC Hardware Diagnostics Windows version from HP

To download HP PC Hardware Diagnostics Windows from HP, follow these steps.

1. Go to <http://www.hp.com/go/techcenter/pcdiags>. The HP PC Diagnostics home page is displayed.
2. Select **Diagnose PC Hardware issues in Windows**, scroll down to the expanded window that appears, and then select **Download**.
3. A pop-up that asks what you want to do with the file opens. Select **Open** or **Save As**. The latest version of the diagnostics tool opens or downloads to the selected location.

Downloading the HP PC Hardware Diagnostics Windows from the Microsoft Store

You can download the HP PC Hardware Diagnostics Windows from the Microsoft Store.

1. Select the Microsoft Store app on your desktop or select the **Search** icon in the taskbar, and then type `Microsoft Store` in the search box.
2. Type `HP PC Hardware Diagnostics Windows` in the **Microsoft Store** search box.
3. Follow the on-screen directions.

The tool downloads to the selected location.

Downloading HP Hardware Diagnostics Windows by product name or number (select products only)

You can download HP PC Hardware Diagnostics Windows by product name or number.

 **NOTE:** For some products, you might have to download the software to a USB flash drive by using the product name or number.

1. Go to <http://www.hp.com/support>.
2. Select **Software and Drivers**, select your type of product, and then enter the product name or number in the search box that is displayed.
3. In the **Diagnostics** section, select **Download**, and then follow the on-screen instructions to select the specific Windows diagnostics version to be downloaded to your computer or USB flash drive.

The tool downloads to the selected location.

Installing HP PC Hardware Diagnostics Windows

To install HP PC Hardware Diagnostics Windows, navigate to the folder on your computer or the USB flash drive where the .exe file downloaded, double-click the .exe file, and then follow the on-screen instructions.

Using HP PC Hardware Diagnostics UEFI

HP PC Hardware Diagnostics Unified Extensible Firmware Interface (UEFI) allows you to run diagnostic tests to determine whether the computer hardware is functioning properly. The tool runs outside the operating system so that it can isolate hardware failures from issues that are caused by the operating system or other software components.

 **NOTE:** For some products, you must use a Windows computer and a USB flash drive to download and create the HP UEFI support environment because only .exe files are provided. For more information, see [Downloading HP PC Hardware Diagnostics UEFI to a USB flash drive on page 74](#).

If your PC does not start in Windows, you can use HP PC Hardware Diagnostics UEFI to diagnose hardware issues.

Using an HP PC Hardware Diagnostics UEFI hardware failure ID code

When HP PC Hardware Diagnostics UEFI detects a failure that requires hardware replacement, a 24-digit failure ID code is generated.

For assistance in solving the problem, complete one of these tasks:

- Select **Contact HP**, accept the HP privacy disclaimer, and then use a mobile device to scan the failure ID code that appears on the next screen. The HP Customer Support - Service Center page appears with your failure ID and product number automatically filled in. Follow the on-screen instructions.
- Contact support, and provide the failure ID code.

Starting HP PC Hardware Diagnostics UEFI

To start HP PC Hardware Diagnostics UEFI, follow this procedure.

1. Turn on or restart the computer, and quickly press **esc**.
2. Press **f2**.

The BIOS searches three places for the diagnostic tools, in the following order:

- a. Connected USB flash drive

 **NOTE:** To download the HP PC Hardware Diagnostics UEFI tool to a USB flash drive, see [Downloading the latest HP PC Hardware Diagnostics UEFI version on page 75](#).

- b. Hard drive

- c. BIOS

3. When the diagnostic tool opens, select the type of diagnostic test that you want to run, and then follow the on-screen instructions.

Starting HP PC Hardware Diagnostics UEFI through HP Hotkey Support software (select products only)

This section describes how to start HP PC Hardware Diagnostics UEFI through HP Hotkey Support software.

 **NOTE:** You must disable Fast Boot to access HP PC Hardware Diagnostics UEFI from the HP System Information application.

To disable Fast Boot:

1. Turn on or restart the computer, and when the HP logo appears, press **f10** to enter Computer Setup.
2. Select **Advanced**, and then select **Boot Options**.
3. Clear **Fast Boot**.
4. Select **Save Changes and Exit**, and then select **Yes**.

To start HP PC Hardware Diagnostics UEFI through HP Hotkey Support software, follow this procedure:

1. From the **Start** menu, open the HP System Information Application or press **fn+esc**.
2. In HP System Information screen, select **Run System Diagnostics**, select **Yes** to run the application, and then select **Restart**.

 **IMPORTANT:** To prevent loss of data, save your work in all open apps before restarting your computer.

 **NOTE:** When the restart is complete, the computer opens the HP PC Hardware Diagnostics UEFI Application. Proceed with the troubleshooting tests.

Downloading HP PC Hardware Diagnostics UEFI to a USB flash drive

Downloading HP PC Hardware Diagnostics UEFI to a USB flash drive can be useful in some situations.

- HP PC Hardware Diagnostics UEFI is not included in the preinstallation image.
- HP PC Hardware Diagnostics UEFI is not included in the HP Tool partition.

- The hard drive is damaged.



NOTE: The HP PC Hardware Diagnostics UEFI downloading instructions are provided in English only, and you must use a Windows computer to download and create the HP UEFI support environment because only .exe files are provided.

Downloading the latest HP PC Hardware Diagnostics UEFI version

To download the latest HP PC Hardware Diagnostics UEFI version to a USB flash drive, follow these steps.

1. Go to <http://www.hp.com/go/techcenter/pcdiags>. The HP PC Diagnostics home page is displayed.
2. Select **Diagnose PC Hardware Issues outside of the OS**, scroll down to the expanded window that appears, and then select **Download**.
3. A pop-up that asks what you want to do with the file opens. Select **Open** or **Save As**. The latest version of the diagnostics tool opens or downloads to the selected location.

Downloading HP PC Hardware Diagnostics UEFI by product name or number (select products only)

You can download HP PC Hardware Diagnostics UEFI by product name or number (select products only) to a USB flash drive.



NOTE: For some products, you might have to download the software to a USB flash drive by using the product name or number.

1. Go to <http://www.hp.com/support>.
2. Enter the product name or number, select your computer, and then select your operating system.
3. In the **Diagnostics** section, follow the on-screen instructions to select and download the specific UEFI Diagnostics version for your computer.

Using Remote HP PC Hardware Diagnostics UEFI settings (select products only)

Remote HP PC Hardware Diagnostics UEFI is a firmware (BIOS) feature that downloads HP PC Hardware Diagnostics UEFI to your computer. It can then run the diagnostics on your computer, and it might upload results to a preconfigured server.

For more information about Remote HP PC Hardware Diagnostics UEFI, go to <http://www.hp.com/go/techcenter/pcdiags>, select **Diagnose Other Potential Issues**, scroll down to **Remote PC Hardware Diagnostics UEFI**, and then select **Learn More**.

Downloading Remote HP PC Hardware Diagnostics UEFI

Remote HP PC Hardware Diagnostics UEFI is also available as a SoftPaq that you can download to a server.

Downloading the latest Remote HP PC Hardware Diagnostics UEFI version

You can download the latest Remote HP PC Hardware Diagnostics UEFI version to a USB flash drive.

1. Go to <http://www.hp.com/go/techcenter/pcdiags>. The HP PC Diagnostics home page is displayed.

2. Select **Diagnose PC Hardware Issues outside of the OS**, scroll down to the expanded window that appears, and then select **Download**.
3. A pop-up that asks what you want to do with the file opens. Select **Open** or **Save As**. The latest version of the diagnostics tool opens or downloads to the selected location.

Downloading Remote HP PC Hardware Diagnostics UEFI by product name or number

You can download Remote HP PC Hardware Diagnostics UEFI by product name or number.

 **NOTE:** For some products, you might have to download the software by using the product name or number.

1. Go to <http://www.hp.com/support>.
2. Select **Software and Drivers**, select your type of product, enter the product name or number in the search box that is displayed, select your computer, and then select your operating system.
3. In the **Diagnostics** section, follow the on-screen instructions to select and download the **Remote UEFI** version for the product.

Customizing Remote HP PC Hardware Diagnostics UEFI settings

Using the Remote HP PC Hardware Diagnostics setting in Computer Setup (BIOS), you can perform several customizations.

- Set a schedule for running diagnostics unattended. You can also start diagnostics immediately in interactive mode by selecting **Execute Remote HP PC Hardware Diagnostics UEFI**.
- Set the location for downloading the diagnostic tools. This feature provides access to the tools from the HP website or from a server that has been preconfigured for use. Your computer does not require the traditional local storage, such as a hard drive or USB flash drive, to run remote diagnostics.
- Set a location for storing the test results. You can also set the user name and password that you use for uploads.
- Display status information about the diagnostics run previously.



To customize Remote HP PC Hardware Diagnostics UEFI settings, follow these steps:

1. Turn on or restart the computer, and when the HP logo appears, press **F10** to enter Computer Setup.
2. Select **Advanced**, and then select **Settings**.
3. Make your customization selections.
4. Select **Main**, then select **Save Changes and Exit** to save your settings.

Your changes take effect when the computer restarts.

9 Backing up, restoring, and recovering

You can use Windows tools or HP software to back up your information, create a restore point, reset your computer, create recovery media, or restore your computer to its factory state. Performing these standard procedures can return your computer to a working state faster.

-
-  **IMPORTANT:** If you are performing recovery procedures on a tablet, the tablet battery must be at least 70% charged before you start the recovery process.
 -  **IMPORTANT:** For a tablet with a detachable keyboard, connect the tablet to the keyboard base before beginning any recovery process.
-

Backing up information and creating recovery media

These methods of creating recovery media and backups are available on select products only.

Using Windows tools for backing up

HP recommends that you back up your information immediately after initial setup. You can do this task either using Windows Backup locally with an external USB flash drive or using online tools.

-
-  **NOTE:** If computer storage is 32 GB or less, Microsoft System Restore is disabled by default.
-

Using the HP Cloud Recovery Download Tool to create a recovery USB flash drive (select products only)

You can use the HP Cloud Recovery Download Tool to create an HP Recovery bootable USB flash drive.

For details:

- Go to <http://www.hp.com>, search for HP Cloud Recovery, and then select the result that matches the type of computer that you have and follow the on-screen instructions.

-
-  **NOTE:** In select countries, if you cannot create the HP Recovery USB flash drive yourself, contact support. Go to <http://www.hp.com/support>, select your country or region, and then follow the on-screen instructions.

-  **IMPORTANT:** HP recommends that you follow the [Restoring and recovery methods on page 78](#) to restore your computer before you obtain and use the HP USB flash drive. Using a recent backup can return your machine to a working state sooner than using the HP USB flash drive. After the system is restored, reinstalling all the operating system software released since your initial purchase can be a lengthy process.
-

Restoring and recovering your system

You have several tools available to recover your system both within and outside of Windows if the desktop cannot load.

HP recommends that you attempt to restore your system using the [Restoring and recovery methods on page 78](#).

Creating a system restore

System Restore is available in Windows. The System Restore software can automatically or manually create restore points, or snapshots, of the system files and settings on the computer at a particular point.

When you use System Restore, it returns your computer to its state at the time you made the restore point. Your personal files and documents should not be affected.

Restoring and recovery methods

After you run the first method, test to see whether the issue still exists before you proceed to the next method, which might now be unnecessary.

1. Run a Microsoft System Restore.
2. Run Reset this PC.

 **NOTE:** The options **Remove everything** and then **Fully clean the drive** can take several hours to complete and leave no information on your computer. It is the safest way to reset your computer before you recycle it.

3. Recover using the HP Recovery USB flash drive. For more information, see [Recovering using the HP Recovery USB flash drive on page 78](#).

For more information about the first two methods, see the Get Help app:

- Select the **Start** button, select **All apps**, select the **Get Help** app, and then enter the task you want to perform.

 **NOTE:** You must be connected to the internet to access the Get Help app.

Recovering using the HP Recovery USB flash drive

You can use the HP Recovery USB flash drive to recover the operating system and drivers that were installed at the factory. On select products, you can create recovery media on a bootable USB flash drive using the HP Cloud Recovery Download Tool.

For details, see [Using the HP Cloud Recovery Download Tool to create a recovery USB flash drive \(select products only\) on page 77](#).

 **NOTE:** In select countries, if you cannot create the HP Recovery USB flash drive yourself, contact support. Go to <http://www.hp.com/support>, select your country or region, and then follow the on-screen instructions.

To recover your system:

- Insert the HP Recovery USB flash drive, and then restart the computer.

 **NOTE:** HP recommends that you follow the [Restoring and recovery methods on page 78](#) to restore your computer before you obtain and use the HP USB flash drive. Using a recent backup can return your machine to a working state sooner than using the HP USB flash drive. After the system is restored, reinstalling all the operating system software released since your initial purchase can be a lengthy process.

Changing the computer boot order

If your computer does not restart using the HP Recovery USB flash drive, you can change the computer boot order, which is the order of devices listed in BIOS for startup information.

 **IMPORTANT:** For a tablet with a detachable keyboard, connect the tablet to the keyboard base before beginning these steps.

To change the boot order:

1. Insert the HP Recovery USB flash drive.
2. Access the system **Startup** menu.
 - For computers or tablets with keyboards attached, turn on or restart the computer or tablet, quickly press **esc**, and then press **f9** for boot options.
 - For tablets without keyboards, turn on or restart the tablet, and then quickly press and hold one of the following buttons:
 - Volume up
 - Volume down

Then select **f9**.
3. Select the USB flash drive to boot from, and then follow the on-screen instructions.

Using HP Sure Recover (select products only)

Select computer models are configured with HP Sure Recover, a PC operating system (OS) recovery solution built into the hardware and software. HP Sure Recover can fully restore the HP OS image without installed recovery software.

Using HP Sure Recover, an administrator or user can restore the system and install:

- Latest version of the OS
- Platform-specific device drivers
- Software applications, in the case of a custom image

To access the latest documentation for HP Sure Recover, go to <http://www.hp.com/support>. Follow the on-screen instructions to find your product and locate your documentation.

10 Specifications

This chapter provides specifications for your computer system.

Computer specifications

This section provides specifications for your computer. When you travel with your computer, the computer dimensions and weights, as well as input power ratings and operating specifications, provide helpful information.

Table 10-1 Computer specifications

	Metric	U.S.
Dimensions		
Width	312.0 mm	12.28 in
Depth	217.5 mm	87.56 in
Height (front)	9.85 mm	0.39 in
Height (rear)	13.68 mm	0.54 in
Height (max)	15.9 mm	0.63 in
Weight		
Nontouch	1335.82 g	2.95 lbs
Touch	1368.42 g	3.02 lbs
Input power		
Operating voltage and current	5 V DC @ 3 A / 9 V DC @ 3 A / 12 V DC @ 5 A / 15 V DC @ 4.33 A / 20 V DC @ 3.25 A - 65 W USB-C	
	5 V DC @ 3 A / 9 V DC @ 3 A / 10 V DC @ 5 A / 12 V DC @ 5 A / 15 V DC @ 4.33 A / 20 V DC @ 3.25 A - 65 W USB-C	
Temperature		
Operating	5°C to 35°C	41°F to 95°F
Nonoperating	-20°C to 60°C	-4°F to 140°F
Relative humidity (noncondensing)		
Operating	10% to 90%	
Nonoperating	5% to 95%	
Maximum altitude (unpressurized)		
Operating	-15 m to 3,048 m	-50 ft to 10,000 ft
Nonoperating	-15 m to 12,192 m	-50 ft to 40,000 ft

 **NOTE:** Applicable product safety standards specify thermal limits for plastic surfaces. The device operates well within this range of temperatures.

Display specifications

This section provides specifications for your display.

Table 10-2 Display specifications

	Metric	U.S.
Active diagonal size	35.6 cm	14.0 in
Resolution	2880 × 1800 (2.8K) 1920 × 1200 (WUXGA)	
Surface treatment	BrightView	
Brightness	300 nits (WUXGA) 500 nits (2.8K)	
Viewing angle	UWVA	
Backlight	OLED	
Display panel interface	eDP	

Solid-state drive specifications

This section provides specifications for your SSDs.

Table 10-3 SSD specifications

	512 GB*	1TB*
Dimensions		
Height	1.0 mm	1.0 mm
Length	50.8 mm	50.8 mm
Width	28.9 mm	28.9 mm
Weight	< 10 g	< 10 g
Interface type		
Ready time, maximum (to not busy)	< 1.0 ms	< 1.0 ms
Access times, logical	0.1 ms	0.1 ms
Transfer rate		
Sequential read	up to 2150 MBps	up to 2150 MBps
Random read	Up to 300,000 IOPS	Up to 300,000 IOPS
Sequential write	up to 1550 MBps	up to 1550 MBps
Random write	Up to 100,000 IOPS	Up to 100,000 IOPS
Total logical sectors		
	1,000,215,216	1,500,336,388
Operating temperature		
	0°C to 70°C (32°F to 158°F)	0°C to 70°C (32°F to 158°F)

*Actual accessible capacity is less. Actual drive specifications might differ slightly.



NOTE: Certain restrictions and exclusions apply. Contact support for details.

11 Power cord set requirements

This chapter provides power cord requirements for countries and regions.

The wide-range input feature of the computer permits it to operate from any line voltage from 100 V AC to 120 V AC, or from 220 V AC to 240 V AC.

The 3-conductor power cord set included with the computer meets the requirements for use in the country or region where the equipment is purchased.

Power cord sets for use in other countries or regions must meet the requirements of the country and region where the computer is used.

Requirements for all countries

These power cord requirements are applicable to all countries and regions.

- The length of the power cord set must be at least **1.0 m** (3.3 ft) and no more than **2.0 m** (6.5 ft).
- All power cord sets must be approved by an acceptable accredited agency responsible for evaluation in the country or region where the power cord set will be used.
- The power cord sets must have a minimum current capacity of 10 A and a nominal voltage rating of 125 V AC or 250 V AC, as required by the power system of each country or region.
- The appliance coupler must meet the mechanical configuration of an EN 60 320/IEC 320 Standard Sheet C13 connector for mating with the appliance inlet on the back of the computer.

Requirements for specific countries and regions

To determine power cord requirements for specific countries and regions, use this table.

Table 11-1 Power cord requirements for specific countries and regions

Country/region	Accredited agency	Applicable note number
Argentina	IRAM	1
Australia	SAA	1
Austria	OVE	1
Belgium	CEBEC	1
Brazil	ABNT	1
Canada	CSA	2
Chile	IMQ	1
Denmark	DEMKO	1
Finland	FIMKO	1
France	UTE	1

Table 11-1 Power cord requirements for specific countries and regions (continued)

Country/region	Accredited agency	Applicable note number
Germany	VDE	1
India	BIS	1
Israel	SII	1
Italy	IMQ	1
Japan	JIS	3
Netherlands	KEMA	1
New Zealand	SANZ	1
Norway	NEMKO	1
The People's Republic of China	CCC	4
Saudi Arabia	SASO	7
Singapore	PSB	1
South Africa	SABS	1
South Korea	KTL	5
Sweden	SEMKO	1
Switzerland	SEV	1
Taiwan	BSMI	6
Thailand	TISI	1
United Kingdom	ASTA	1
United States	UL	2

1. The flexible cord must be Type HO5VV-F, 3-conductor, 0.75 mm² conductor size. Power cord set fittings (appliance coupler and wall plug) must bear the certification mark of the agency responsible for evaluation in the country or region where it will be used.
2. The flexible cord must be Type SVT/SJT or equivalent, No. 18 AWG, 3-conductor. The wall plug must be a 2-pole grounding type with a NEMA 5-15P (15 A, 125 V AC) or NEMA 6-15P (15 A, 250 V AC) configuration. CSA or C-UL mark. UL file number must be on each element.
3. The appliance coupler, flexible cord, and wall plug must bear a T mark and registration number in accordance with the Japanese Dentori Law. The flexible cord must be Type VCTF, 3-conductor, 0.75 mm² or 1.25 mm² conductor size. The wall plug must be a 2-pole grounding type with a Japanese Industrial Standard C8303 (7 A, 125 V AC) configuration.
4. The flexible cord must be Type RVV, 3-conductor, 0.75 mm² conductor size. Power cord set fittings (appliance coupler and wall plug) must bear the CCC certification mark.
5. The flexible cord must be Type HO5VV-F 3-conductor, 0.75 mm² conductor size. KTL logo and individual approval number must be on each element. Approval number and logo must be printed on a flag label.
6. The flexible cord must be Type HVCTF 3-conductor, 1.25 mm² conductor size. Power cord set fittings (appliance coupler, cable, and wall plug) must bear the BSMI certification mark.

7. For 127 V AC, the flexible cord must be Type SVT or SJT 3-conductor, 18 AWG, with plug NEMA 5-15P (15 A, 125 V AC), with UL and CSA or C-UL marks. For 240 V AC, the flexible cord must be Type H05VV-F 3-conductor, 0.75 mm² or 1.00 mm² conductor size, with plug BS 1363/A with BSI or ASTA marks.

12 Swelling or deformation of notebook battery

To protect your hardware from potential damage, HP recommends that if you are experiencing battery swelling, stop using the notebook until you can replace the battery.

You can contact HP to understand what battery replacement options are available. To learn more about lithium-ion batteries and the factors that can accelerate battery swelling, see https://support.hp.com/us-en/document/ish_6824662-6824706-16.

Swollen notebook batteries

You might notice that your notebook battery has become somewhat deformed or swollen over time. In some cases, the battery swelling might be significant enough to impact other components of the system including the touchpad, keyboard, and chassis.

Swollen battery is not a safety issue

A swollen battery does not present a safety issue. It is the result of the generation of gases per the normal degradation of the battery cell over time.

HP has worked closely with our battery cell suppliers and third-party industry experts to help minimize the potential for HP batteries to swell over time and to identify that swollen batteries are not a safety issue.

Discontinue using a swollen battery

To protect your hardware from potential damage, HP recommends that, if you are experiencing battery swelling, you stop using the notebook until the battery can be replaced.

You can contact <https://www.hp.com/go/contacthp> to understand what battery replacement options are available.

Replace a swollen battery

If a battery is under warranty, HP will replace the battery per the terms and conditions of the HP Worldwide Limited Warranty or applicable HP Care Packs.

For batteries no longer under warranty, contact HP to purchase a genuine HP replacement battery.

Minimize battery swelling

Multiple factors can accelerate battery swelling.

To help mitigate battery swelling over time, you can use either HP Adaptive Battery Optimizer (consumer notebooks) or HP Battery Health Manager (commercial notebooks) settings to improve battery longevity and performance for various use scenarios.

Adaptive Battery Optimizer (consumer notebooks)

Adaptive Battery Optimizer technology can help mitigate the factors that cause the battery to swell. It is available on select HP OMEN, HP Spectre, HP Pavilion, and HP ENVY notebook computers.

Adaptive Battery Optimizer has been available on select gaming notebooks since 2019 and select consumer notebooks since 2020. To learn more about enabling Adaptive Battery Optimizer on your HP notebook, see https://support.hp.com/us-en/document/ish_9908083-9908127-16.

HP Battery Health Manager (commercial notebooks)

HP Battery Health Manager provides an easy-to-manage solution to help mitigate factors that cause the battery to swell. It is available on select HP ProBook and HP EliteBook notebook computers.

HP Battery Health Manager is available on select commercial notebooks manufactured since 2016. To learn more about HP Battery Health Manager, see https://support.hp.com/us-en/document/ish_4449597-3519507-16.

13 Recycling

When a nonrechargeable or rechargeable battery has reached the end of its useful life, do not dispose of the battery in general household waste. Follow the local laws and regulations in your area for battery disposal.

HP encourages customers to recycle used electronic hardware, HP original print cartridges, and rechargeable batteries. For more information about recycling programs, see the HP website at <http://www.hp.com/recycle>.

Index

A

- AC adapter and battery light, identifying 7
- AC adapters, spare part numbers 20
- action key, identifying 12
- audio-out (headphone)/audio-in (microphone) combo jack, identifying 6
- audio, product description 3

B

- backup, creating 77
- backups 77
- battery
 - illustrated 16
 - spare part number 16
- battery swelling 86
- BIOS
 - determining version 68
 - downloading an update 69, 70
 - starting the Setup Utility 68
 - updating 68
- Bluetooth label 14
- boot order, changing 79
- bottom components 13
- bottom cover
 - illustrated 16
 - removal 30
 - spare part number 16, 30
- buttons
 - left touchpad 9, 10
 - right touchpad 9, 10

C

- camera
 - identifying 9
 - illustrated 19
 - spare part number 19
- camera lights, identifying 8
- caps lock light 11
- caring for your computer 26
- cautions
 - electrostatic discharge 22, 23
- cleaning your computer 26
 - caring for wood veneer 28
 - disinfecting 27

- HP Easy Clean 26
 - removing dirt and debris 26
- components
 - bottom 13
 - display 7, 8
 - keyboard area 9
 - left side 6
 - lights 10
 - right side 6
 - touchpad 9, 10
- computer major components 15
- computer specifications 80
- control zone 9

D

- display
 - specifications 80, 81
- display assembly
 - subcomponents 18
- display back cover
 - illustrated 20
 - spare part number 20
- display cable
 - illustrated 19
 - spare part number 19
- display components 7
- display panel
 - illustrated 19
 - product description 2
 - spare part number 19

E

- electrostatic discharge (ESD) 22, 23
 - preventing damage 22-24
- esc key, identifying 12

F

- fan
 - illustrated 16
 - removal 46
 - spare part number 16, 46
- fn key, identifying 12

G

- graphics, product description 2
- grounding methods 22-24

- guidelines
 - packaging 22, 28
 - transporting 22, 28
 - workstation 22

H

- hard drive
 - product description 3
 - specifications 80
- HDMI port
 - identifying 7
- heat sink
 - illustrated 16, 54
 - removal 54
 - spare part number 16, 54
 - spare part numbers 54
- HP PC Hardware Diagnostics UEFI
 - downloading 74
 - failure ID code 73
 - HP Hotkey Support software 74
 - starting 73, 74
 - using 73
- HP PC Hardware Diagnostics Windows
 - accessing 71, 72
 - downloading 72
 - failure ID code 71
 - installing 73
 - using 71
- HP Recovery media
 - recovery 78
- HP Sure Recover 79

I

- I/O board
 - removal 49
 - spare part number 49
- illustrated parts catalog 15
- internal microphones, identifying 9

J

- jacks
 - audio-out (headphone)/audio-in (microphone) 6

- K**
- keyboard
 - product description 4
- keyboard country codes 66
- keys
 - action 12
 - esc 12
 - fn 12
 - power 13
 - Windows 12
- L**
- labels
 - Bluetooth 14
 - regulatory 14
 - serial number 14
 - service 14
 - wireless certification 14
 - WLAN 14
- left control zone, identifying 9
- left side components 6
- lights
 - camera 8
 - caps lock 11
 - microphone mute 11
 - mute 11
 - power 7, 11
 - touchpad 9
- low blue light mode 8
- M**
- memory module
 - product description 2
- microphone
 - product description 3
- microphone mute light, identifying 11
- mute light, identifying 11
- O**
- OLED board
 - removal 49
 - spare part number 49
- operating system, product description 5
- P**
- packaging guidelines 22, 28
- pointing device, product description 4
- ports
 - HDMI 7
- product description 4
- USB port 6, 7
- power cord
 - requirements for all countries 83
 - requirements for specific countries and regions 83
 - set requirements 83
- power cords, spare part numbers 20
- power key, identifying 13
- power light, identifying 11
- power requirements, product description 4
- primary storage
 - product description 3
- processor
 - product description 1
- product description
 - audio 3
 - display panel 2
 - graphics 2
 - hard drive 3
 - keyboard 4
 - memory module 2
 - microphone 3
 - operating system 5
 - pointing device 4
 - ports 4
 - power requirements 4
 - primary storage 3
 - processors 1
 - security 5
 - serviceability 5
 - solid-state drive 3
 - video 3
 - wireless 3
- product name and number, computer 14
- R**
- recovery 77
 - discs 78
 - media 78
 - USB flash drive 78
- recovery media 77
 - creating using HP Cloud Recovery Download Tool 77
 - creating using Windows tools 77
- regulatory information
 - regulatory label 14
 - wireless certification labels 14
- Remote HP PC Hardware
 - Diagnostics UEFI settings
 - customizing 76
 - using 75
 - removal and replacement
 - procedures 30, 41
 - solid-state drive 41
 - restoring 77
 - restoring and recovery
 - methods 78
 - right control zone, identifying 9
 - right side components 6
- S**
- Screw Kit, spare part number 20
- security, product description 5
- serial number, computer 14
- service labels, locating 14
- serviceability, product description 5
- solid-state drive
 - illustrated 18
 - product description 3
 - removal and replacement 41
 - spare part number 18
 - specifications 81
- speaker
 - illustrated 16
 - removal 45
 - spare part number 16
 - spare part numbers 45
- speakers, identifying 13
- special keys
 - identifying 12
 - using 12
- specifications
 - computer 80
 - display 80, 81
 - hard drive 80
 - solid-state drive 81
- static electricity 22, 23
- support information 28
- swelling or deformation of notebook battery 86
- system board
 - illustrated 16, 17, 50, 51
 - removal 50
 - spare part number 16, 17, 50, 51
 - spare part numbers 50
- system restore 78
- system restore point, creating 77

T

- top cover with keyboard
 - illustrated 16
 - spare part number 16
 - spare part numbers 66
- touch control
 - spare part number 20
- touch control board
 - illustrated 20
- touchpad
 - illustrated 16
 - removal 47
 - settings 9
 - spare part number 16
 - spare part numbers 47
- touchpad buttons
 - identifying 9,10
- touchpad components 9
- touchpad light, identifying 9
- touchpad settings, adjusting 9
- touchpad zone, identifying 9,10
- transporting guidelines 22, 28
- traveling with the computer 14

U

- USB port, identifying 6,7

V

- vent, identifying 14
- video, product description 3

W

- Windows
 - backup 77
 - recovery media 77
 - system restore point 77
- Windows key, identifying 12
- Windows tools, using 77
- wireless antennas
 - illustrated 19
 - spare part number 19
- wireless antennas, identifying 8
- wireless certification label 14
- wireless, product description 3
- WLAN antennas, identifying 8
- WLAN device 14
- WLAN label 14
- WLAN module
 - illustrated 17, 43
 - removal 43
 - spare part number 17, 43
- workstation guidelines 22