



Maintenance and Service Guide

HP 14s Laptop PC

IMPORTANT! This document is intended for HP authorized service providers only.

© Copyright 2020 HP Development Company, L.P.

Bluetooth is a trademark owned by its proprietor and used by HP Inc. under license. Intel, Core, and XMM are trademarks of Intel Corporation or its subsidiaries in the U.S. and/or other countries. SDHC, SDXC, and microSD are trademarks or registered trademarks of SD-3C LLC. Windows is either a registered trademark or trademark of Microsoft Corporation in the United States and/or other countries.

The information contained herein is subject to change without notice. The only warranties for HP products and services are set forth in the express warranty statements accompanying such products and services. Nothing herein should be construed as constituting an additional warranty. HP shall not be liable for technical or editorial errors or omissions contained herein.

First Edition: March 2020

Document Part Number: L87918-001

Product notice

This guide describes features that are common to most models. Some features may not be available on your computer.

Not all features are available in all editions or versions of Windows. Systems may require upgraded and/or separately purchased hardware, drivers, software or BIOS update to take full advantage of Windows functionality. Windows 10 is automatically updated, which is always enabled. ISP fees may apply and additional requirements may apply over time for updates. Go to <http://www.microsoft.com> for details.

To access the latest user guides, go to <http://www.hp.com/support>, and follow the instructions to find your product. Then select **User Guides**.

Software terms

By installing, copying, downloading, or otherwise using any software product preinstalled on this computer, you agree to be bound by the terms of the HP End User License Agreement (EULA). If you do not accept these license terms, your sole remedy is to return the entire unused product (hardware and software) within 14 days for a full refund subject to the refund policy of your seller.

For any further information or to request a full refund of the price of the computer, please contact your seller.

Safety warning notice

 **WARNING!** To reduce the possibility of heat-related injuries or of overheating the device, do not place the device directly on your lap or obstruct the device air vents. Use the device only on a hard, flat surface. Do not allow another hard surface, such as an adjoining optional printer, or a soft surface, such as pillows or rugs or clothing, to block airflow. Also, do not allow the AC adapter to contact the skin or a soft surface, such as pillows or rugs or clothing, during operation. The device and the AC adapter comply with the user-accessible surface temperature limits defined by applicable safety standards.

Table of contents

1 Product description	1
2 Getting to know your computer	4
Right side	4
Left side	5
Display	6
Keyboard area	7
Touchpad	7
Touchpad settings	7
Lights	8
Button, speakers, and vent	9
Special keys	10
Bottom	11
Labels	12
3 Illustrated parts catalog	13
Computer major components	13
Display assembly subcomponents	15
Miscellaneous parts	16
4 Removal and replacement procedures preliminary requirements	17
Tools required	17
Service considerations	17
Plastic parts	17
Cables and connectors	17
Drive handling	18
Workstation guidelines	18
Electrostatic discharge information	18
Generating static electricity	19
Preventing electrostatic damage to equipment	19
Personal grounding methods and equipment	20
Grounding the work area	20
Recommended materials and equipment	20
Packaging and transporting guidelines	21

5 Removal and replacement procedures for authorized service provider parts	22
Component replacement procedures	22
Preparation for disassembly	22
Bottom cover	23
Battery	25
Memory module	26
Solid-state drive	28
Hard drive	29
WLAN module	31
WWAN module	33
USB, card reader, and power button board	35
Speaker assembly	36
Power connector	37
Touchpad click board	39
Touchpad	40
Fan	41
Heat sink (thermal module)	42
System board	44
Display assembly	46
Top cover/keyboard	53
6 Using Setup Utility (BIOS)	54
Starting Setup Utility (BIOS)	54
Updating Setup Utility (BIOS)	54
Determining the BIOS version	54
Downloading a BIOS update	55
7 Using HP PC Hardware Diagnostics	56
Using HP PC Hardware Diagnostics Windows (select products only)	56
Downloading HP PC Hardware Diagnostics Windows	56
Downloading the latest HP PC Hardware Diagnostics Windows version	57
Downloading HP Hardware Diagnostics Windows by product name or number (select products only)	57
Installing HP PC Hardware Diagnostics Windows	57
Using HP PC Hardware Diagnostics UEFI	57
Starting HP PC Hardware Diagnostics UEFI	58
Downloading HP PC Hardware Diagnostics UEFI to a USB flash drive	58
Downloading the latest HP PC Hardware Diagnostics UEFI version	58
Downloading HP PC Hardware Diagnostics UEFI by product name or number (select products only)	59
Using Remote HP PC Hardware Diagnostics UEFI settings (select products only)	59

Downloading Remote HP PC Hardware Diagnostics UEFI	59
Downloading the latest Remote HP PC Hardware Diagnostics UEFI version	59
Downloading Remote HP PC Hardware Diagnostics UEFI by product name or number	59
Customizing Remote HP PC Hardware Diagnostics UEFI settings	59
8 Backing up, restoring, and recovering	61
Backing up information and creating recovery media	61
Using Windows tools	61
Using the HP Cloud Recovery Download Tool to create recovery media (select products only)	61
Restoring and recovery	62
Restoring, resetting, and refreshing using Windows tools	62
Recovering using HP Recovery media	62
Changing the computer boot order	62
Using HP Sure Recover (select products only)	63
9 Specifications	64
Computer specifications	64
35.6 cm (14.0 in) display specifications	65
M.2 PCIe solid-state drive specifications	66
Hard drive specifications	67
10 Power cord set requirements	68
Requirements for all countries	68
Requirements for specific countries and regions	69
11 Recycling	71
Index	72

1 Product description

Table 1-1 Product components and their descriptions

Category	Description
Product Name	HP 14s Laptop PC Model numbers: 14s-ef0xxx, 14s-er0xxx, 14s-es0xxx
Processor	10th generation Intel® Core™ processors i5-1035G1 (1.0 GHz, turbo up to 3.6 GHz, quad core, 3200 MHz FSB, 6 MB L3 cache, 13 W) i3-1005G1 (1.2 GHz, turbo up to 3.4 GHz, dual core, 3200 MHz FSB, 4 MB L3 cache, 13 W)
Graphics	Internal graphics Intel UHD Supports HD decode, DX12, and HDMI
Display panel	35.6 cm (14.0 in), slim-flat (3.0 mm), narrow bezel, 45% NTSC Full high-definition (FHD) (1920 × 1080), BrightView, WLED, UWVA, eDP, 250 nits
Memory	One SODIMM slot, not customer accessible or upgradeable DDR4-2666 single-channel support (DDR4-3200 bridge to DDR4-2666) Supports up to 8 GB maximum system memory in the following configurations: <ul style="list-style-type: none">• 8 GB• 4 GB
Storage	Supports 7.2/9.5 mm, 2.5 inch SATA hard drives (7.2 mm and 9.5 mm hard drives use same bracket) Support for solid-state drive + hard drive Support for M.2 SATA/PCIe solid-state drive Dual storage configuration 256 GB, PCIe, value + 1 TB hard drive Single hard drive configuration 1 TB, 5400 rpm hard drive
Audio	Audio application name HP Audio Center Dual speakers
Video	HP TrueVision HD Camera - indicator LED, USB 2.0, HD BSI sensor, f2.0 720p by 30 frames per second Single digital microphone
Wireless networking	Integrated wireless option with dual antennas (M.2/PCIe) Realtek RTL8822CE 802.11ac 2 × 2 Wi-Fi + Bluetooth® 5.0 (MU-MIMO supported)

Table 1-1 Product components and their descriptions (continued)

Category	Description
	<p>Integrated wireless option with dual antennas (M.2/MIPI/BRI)</p> <p>Intel Wi-Fi 6 AX201 + Bluetooth 5 (non-vPro) (802.11ax 2 × 2, MU-MIMO, supporting gigabit file transfer speeds)</p>
	<p>Integrated WWAN and GPS function (M.2)</p> <p>Intel® XMM™ 7360 LTE-Advanced (CAT 9)</p> <p>Supports HSPA+/LTE/GPS/A-GPS</p> <p>Supports eSIM (MFF2) (physical eSIM only)</p>
Ports	<p>HP Smart Pin AC adapter</p> <p>Audio-out (headphone)/Audio-in (microphone) combo jack</p> <p>High-definition multimedia interface (HDMI) v.1.4 supporting up to 1920 × 1080 at 60 Hz</p> <p>Hot plug/unplug and autodetect for correct output to wide-aspect vs. standard aspect video (auto adjust panel resolution to fit embedded panel and external monitor connected)</p> <p>(2) USB 3.1 Type A ports</p> <p>(1) USB 3.1 Gen 1 Type-C port</p>
Media card reader	<p>Supports microSD™, SDHC™, SDXC™</p> <p>Push-pull insertion and removal</p>
Internal card expansion	<p>One M.2 slot for WLAN</p> <p>One M.2 slot for solid-state drive</p>
Keyboard/pointing devices	<p>Keyboard, full size, island style</p> <p>2-coat paint</p> <p>3-coat paint, backlit</p> <p>Touchpad requirements</p> <p>Touchpad with image sensor</p> <p>Multitouch gestures enabled</p> <p>Support for modern trackpad gestures</p> <p>Taps enabled as default</p>
Power requirements	<p>Battery</p> <p>3 cell, 41 Whr, polymer battery</p> <p>Supports battery life enhancement</p> <p>Supports battery fast charge (45 minutes, 50% charged)</p> <p>Smart AC adapter (65 W, nPFC, slim barrel, EM, 4.5 mm)</p> <p>Power cord (C5, 1 m, conventional)</p>
Security	<p>Trusted Platform Module (fTPM) 2.0, firmware based</p> <p>Mini security cable slot</p>

Table 1-1 Product components and their descriptions (continued)

Category	Description
Operating system	Preinstalled
	Windows® 10 Home 64 Plus Single Language India Market
	Windows 10 Home 64 Single Language India Market
	FreeDOS 3.0
Serviceability	User replaceable part
	AC adapter

2 Getting to know your computer

Your computer features top-rated components. This chapter provides details about your components, where they are located, and how they work.

Right side

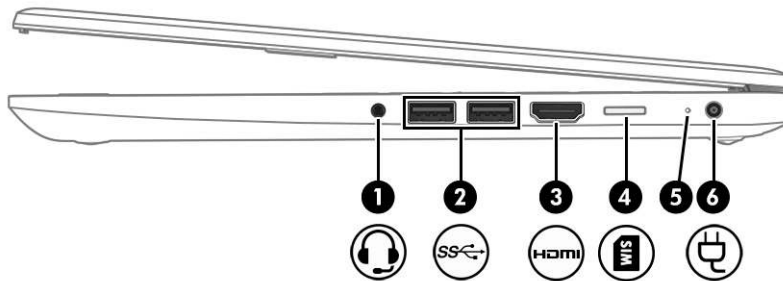

Table 2-1 Right-side components and their descriptions







Component	Description
(1) 	<p>Audio-out (headphone)/Audio-in (microphone) combo jack</p> <p>Connects optional powered stereo speakers, headphones, earbuds, a headset, or a television audio cable. Also connects an optional headset microphone. This jack does not support optional standalone microphones.</p> <p>WARNING! To reduce the risk of personal injury, adjust the volume before putting on headphones, earbuds, or a headset. For additional safety information, see the <i>Regulatory, Safety, and Environmental Notices</i>.</p> <p>To access this guide:</p> <ul style="list-style-type: none">▲ Type <code>HP Documentation</code> in the taskbar search box, and then select HP Documentation. <p>NOTE: When a device is connected to the jack, the computer speakers are disabled.</p>
(2) 	<p>USB SuperSpeed ports (2)</p> <p>Connect a USB device, such as a cell phone, camera, activity tracker, or smartwatch, and provide high-speed data transfer.</p>
(3) 	<p>HDMI port</p> <p>Connects an optional video or audio device, such as a high-definition television, any compatible digital or audio component, or a high-speed High-Definition Multimedia Interface (HDMI) device.</p>
(4) 	<p>SIM card slot</p> <p>Supports a wireless subscriber identity module (SIM) card.</p>
(5) 	<p>AC adapter and battery light</p> <ul style="list-style-type: none">• White: The AC adapter is connected and the battery is fully charged.• Blinking white: The AC adapter is disconnected and the battery has reached a low battery level.• Amber: The AC adapter is connected and the battery is charging.

Table 2-1 Right-side components and their descriptions (continued)

Component	Description
(6)  Power connector	<ul style="list-style-type: none"> Off: The battery is not charging. <p>Connects an AC adapter.</p>

Left side

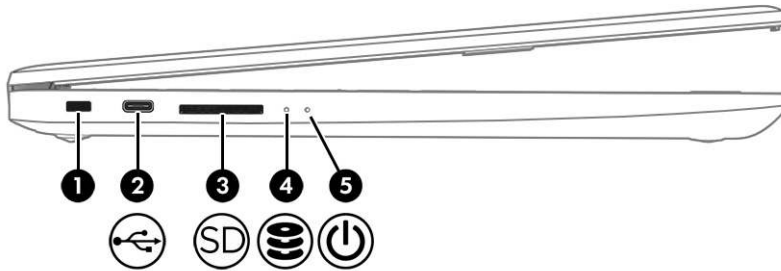







Table 2-2 Left-side components and their descriptions

Component	Description
(1)  Security cable slot	<p>Attaches an optional security cable to the computer.</p> <p>NOTE: The security cable is designed to act as a deterrent, but it might not prevent the computer from being mishandled or stolen.</p>
(2)  USB Type-C port	<p>Connects a USB device, such as a cell phone, camera, activity tracker, or smartwatch, and provides data transfer.</p> <p>NOTE: Cables, adapters, or both (purchased separately) might be required.</p>
(3)  Memory card reader	<p>Reads optional memory cards that enable you to store, manage, share, or access information.</p> <p>To insert a card:</p> <ol style="list-style-type: none"> Hold the card label-side up, with connectors facing the computer. Insert the card into the memory card reader, and then press in on the card until it is firmly seated. <p>To remove a card:</p> <ul style="list-style-type: none"> ▲ Pull the card out of the memory card reader.
(4)  Drive light (select products only)	<ul style="list-style-type: none"> Blinking white: The hard drive is being accessed.
(5)  Power light	<ul style="list-style-type: none"> On: The computer is on. Blinking: (select products only): The computer is in the Sleep state, a power-saving state. The computer shuts off power to the display and other unnecessary components. Off: Depending on your computer model, the computer is off, in Hibernation, or in Sleep. Hibernation is the power-saving state that uses the least amount of power.

Display

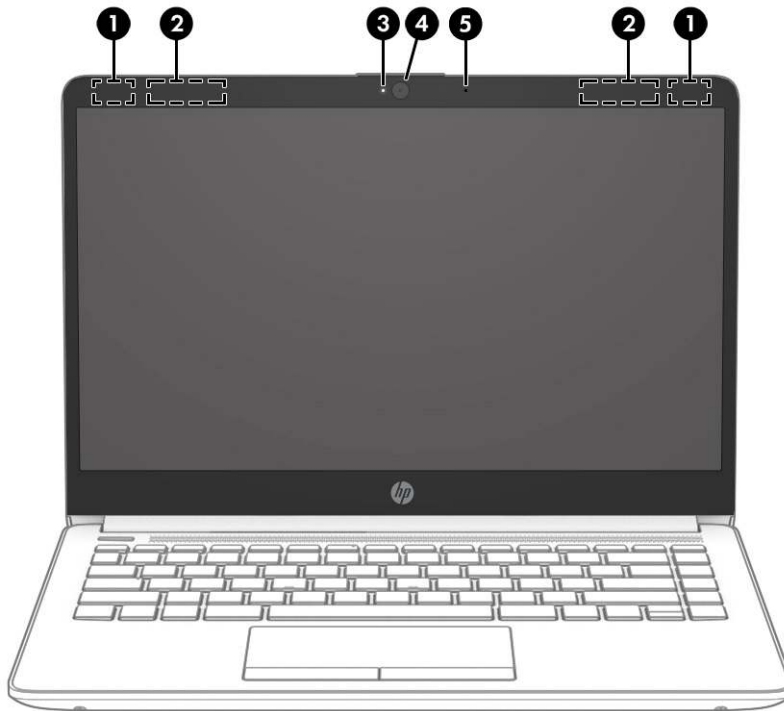

Table 2-3 Display components and their descriptions

Component	Description
(1) WLAN antennas* (2)	Send and receive wireless signals to communicate with wireless local area networks (WLANs).
(2) WWAN antennas* (2)	Send and receive wireless signals to communicate with wireless wide area networks (WWANs).
(3) Camera light	On: The camera is in use.
(4) Camera	Allows you to video chat, record video, and record still images. Some cameras also allow a facial recognition logon to Windows, instead of a password logon. NOTE: Camera functions vary depending on the camera hardware and software installed on your product.
(5) Internal microphone	Records sound.

*The antennas are not visible from the outside of the computer. For optimal transmission, keep the areas immediately around the antennas free from obstructions.

For wireless regulatory notices, see the section of the *Regulatory, Safety, and Environmental Notices* that applies to your country or region.

To access this guide:

▲ Type **HP Documentation** in the taskbar search box, and then select **HP Documentation**.

Keyboard area

 **NOTE:** Keyboards can vary by language.

Touchpad

Touchpad settings

To adjust touchpad settings and gestures, or to turn off the touchpad:

1. Type `touchpad settings` in the taskbar search box, and then press [enter](#).
2. Choose a setting.

To turn on the touchpad:

1. Type `touchpad settings` in the taskbar search box, and then press [enter](#).
2. Using an external mouse, click the **touchpad** button.

– or –

- ▲ Press the [Tab](#) key repeatedly until the pointer rests on the **touchpad** button. Then press the [spacebar](#) to select the button.

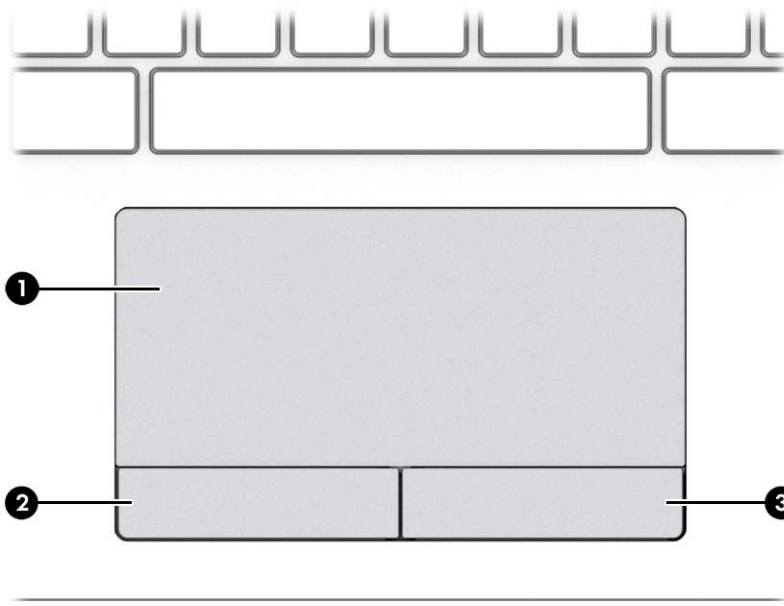

Table 2-4 Touchpad components and their descriptions

Component	Description
(1) Touchpad zone	Reads your finger gestures to move the pointer or activate items on the screen.
(2) Left touchpad button	Functions like the left button on an external mouse.
(3) Right touchpad button	Functions like the right button on an external mouse.

Lights

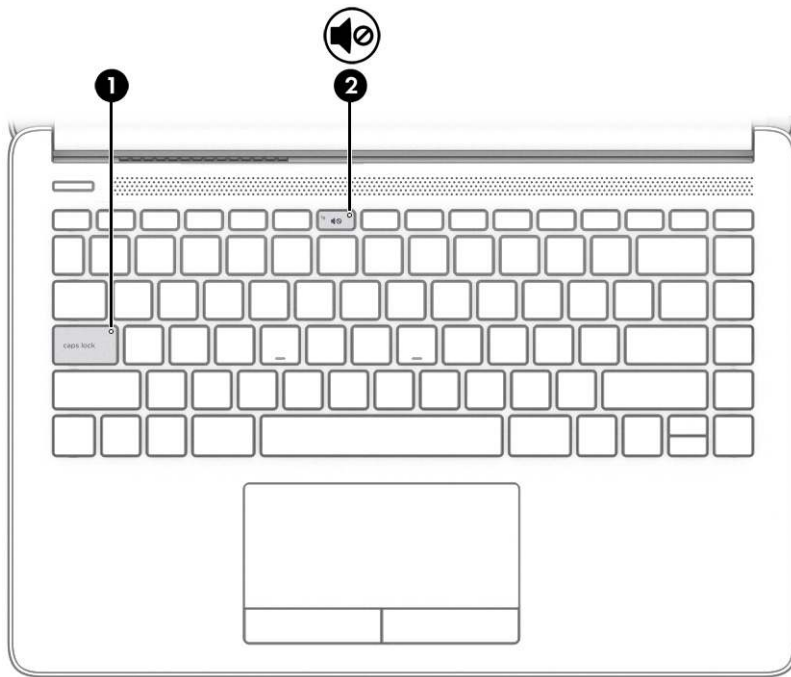



Table 2-5 Lights and their descriptions

Component	Description
(1) Caps lock light	On: Caps lock is on, which switches the key input to all capital letters.
(2)  Mute light	<ul style="list-style-type: none">• On: Computer sound is off.• Off: Computer sound is on.

Button, speakers, and vent

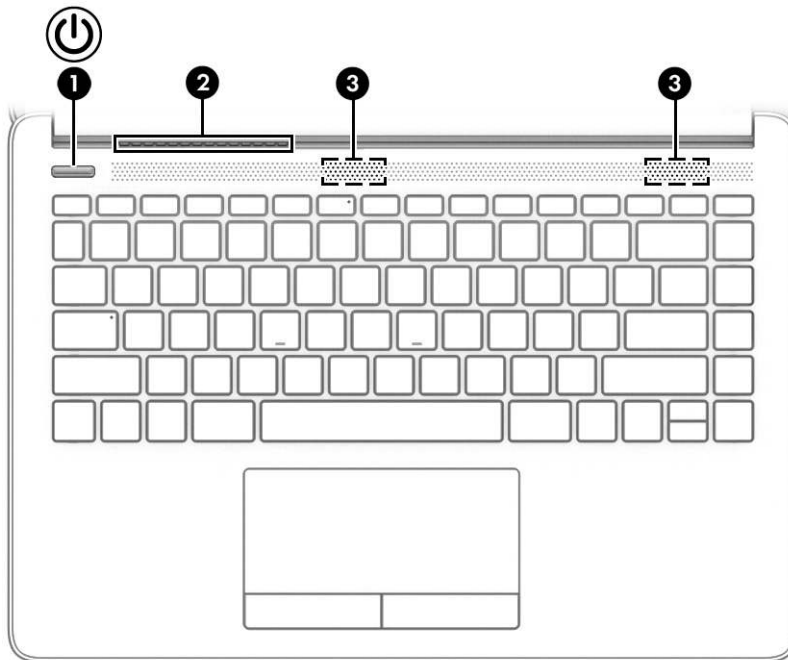



Table 2-6 Button, speakers, and vent

Component	Description
(1)  Power button	<ul style="list-style-type: none"> • When the computer is off, press the button to turn on the computer. • When the computer is on, press the button briefly to initiate Sleep. • When the computer is in the Sleep state, press the button briefly to exit Sleep (select products only). • When the computer is in Hibernation, press the button briefly to exit Hibernation. <p>IMPORTANT: Pressing and holding down the power button results in the loss of unsaved information.</p> <p>If the computer has stopped responding and shutdown procedures are ineffective, press and hold the power button down for at least 10 seconds to turn off the computer.</p> <p>To learn more about your power settings, see your power options:</p> <p>▲ Right-click the Power icon , and then select Power Options.</p>
(2) Vent	<p>Enables airflow to cool internal components.</p> <p>NOTE: The computer fan starts up automatically to cool internal components and prevent overheating. It is normal for the internal fan to cycle on and off during routine operation.</p>
(3) Speakers (2)	Produce sound.

Special keys

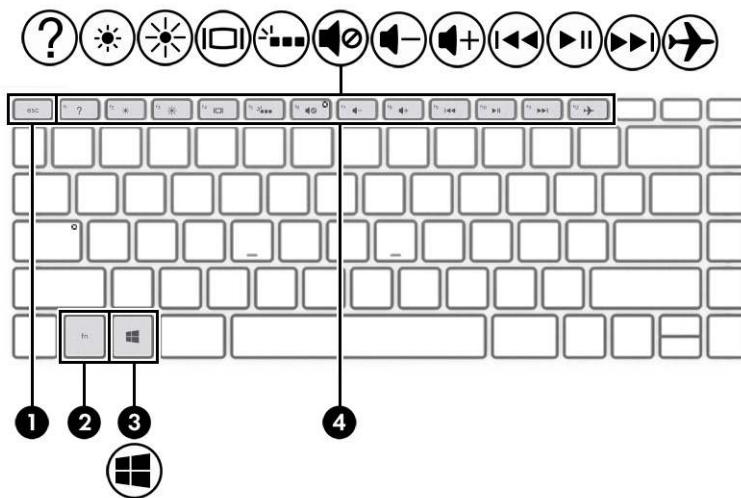



Table 2-7 Special keys and their descriptions

Component	Description
(1) <code>esc</code> key	Displays system information when pressed in combination with the <code>fn</code> key.
(2) <code>fn</code> key	Executes specific functions when pressed in combination with another key.
(3)  Windows key	Opens the Start menu. NOTE: Pressing the Windows key again closes the Start menu.
(4) Action keys	Execute frequently used system functions.

Bottom

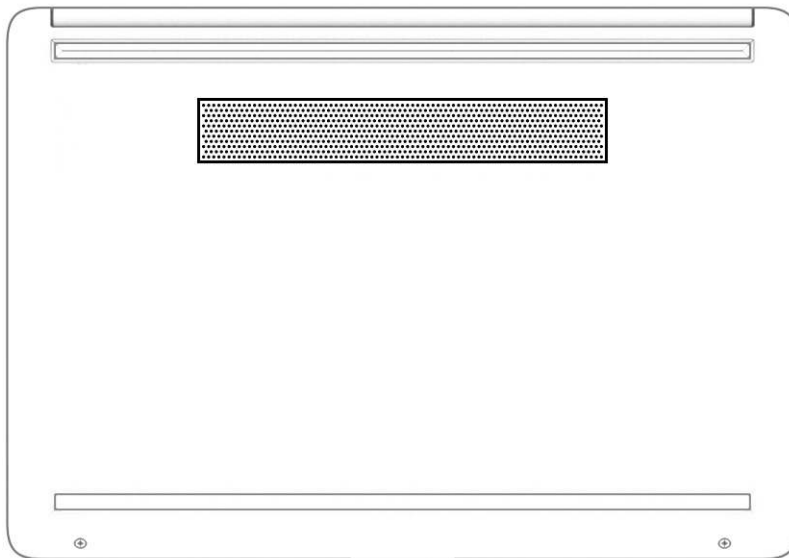

Table 2-8 Bottom components and their descriptions

Component	Description
Vent	Enables airflow to cool internal components. NOTE: The computer fan starts up automatically to cool internal components and prevent overheating. It is normal for the internal fan to cycle on and off during routine operation.

Labels

The labels affixed to the computer provide information that you might need when you troubleshoot system problems or travel internationally with the computer. Labels can be in paper form or imprinted on the product.

IMPORTANT: Check the following locations for the labels described in this section: the bottom of the computer, inside the battery bay, under the service door, on the back of the display, or on the bottom of a tablet kickstand.

- Service label—Provides important information to identify your computer. When contacting support, you might be asked for the serial number, the product number, or the model number. Locate this information before you contact support.

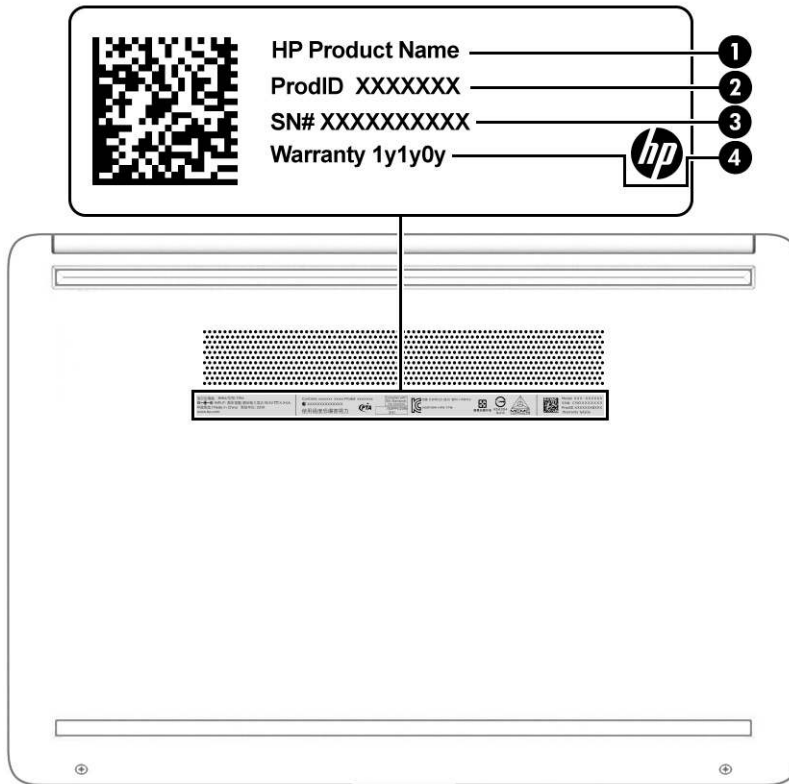

Table 2-9 Service label components

Component
(1) HP product name
(1) Product ID
(3) Serial number
(4) Warranty period

- Regulatory label(s)—Provide(s) regulatory information about the computer.
- Wireless certification label(s)—Provide(s) information about optional wireless devices and the approval markings for the countries or regions in which the devices have been approved for use.

3 Illustrated parts catalog

Computer major components

 **NOTE:** HP continually improves and changes product parts. For complete and current information about supported parts for your computer, go to <http://partsurfer.hp.com>, select your country or region, and then follow the on-screen instructions.

 **NOTE:** Details about your computer, including model, serial number, product key, and length of warranty, are on the service tag at the bottom of your computer. See [Labels on page 12](#) for details.

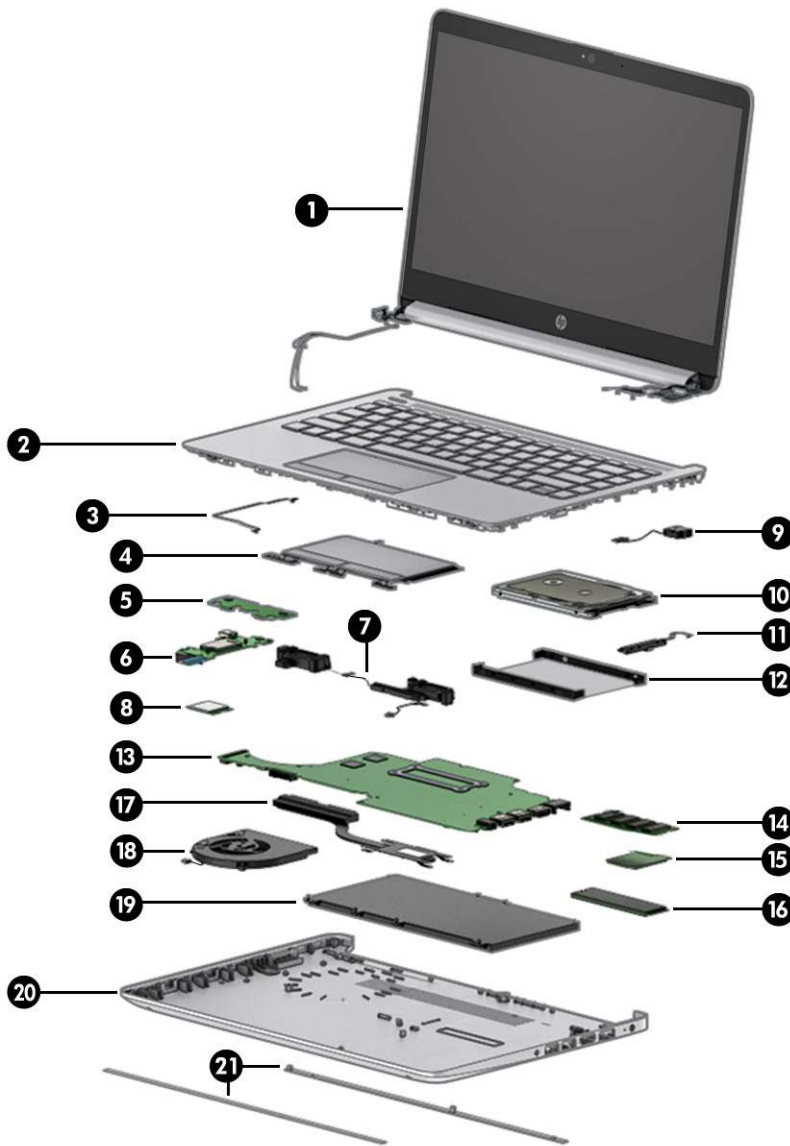

Table 3-1 Computer major components and their descriptions

Item	Component	Spare part number
(1)	Display assembly NOTE: Display assemblies are offered as spare parts only at a subcomponent level.	
(2)	Keyboard/top cover (includes touchpad and touchpad protective tape) No backlight Backlit	L96982-001 L96983-001
(3)	Touchpad board cable	L23184-001
(4)	Touchpad (includes gasket)	L24484-001
(5)	Touchpad click board NOTE: The touchpad click board cable is available as spare part number L24485-001.	M05046-001
(6)	USB/card reader/power button board NOTE: The USB/card reader/power button board cable is available as spare part number L23186-001.	M05045-001
(7)	Speaker assembly	L24489-001
(8)	WLAN module Realtek RTL8822CE 802.11ac 2 × 2 Wi-Fi + Bluetooth 5.0 Intel Wi-Fi 6 AX201 + Bluetooth 5 (non-vPro) (802.11ax 2 × 2)	L44796-005 L57250-005
(9)	Power connector cable:	L23188-001
(10)	Hard drive (1 TB, 5400 rpm, 7 mm)	762990-005
(11)	Hard drive cable	L23187-001
(12)	Hard drive cover	L24490-001
(13)	System board (includes processor) Intel Core i5-1035G1 processor for use in models with a non-Windows operating system Intel Core i5-1035G1 processor for use in models with a Windows operating system Intel Core i3-1005G1 processor for use in models with a non-Windows operating system Intel Core i3-1005G1 processor for use in models with a Windows operating system	L96985-001 L96985-601 L96984-001 L96984-601
(14)	Memory module (DDR4-2666) 8 GB 4 GB	937236-855 L10598-855
(15)	WWAN module (Intel XMM 7360 LTE-Advanced (CAT 9))	L70670-005
(16)	Solid-state drive (M.2) (256 GB, PCIe)	L85354-005
(17)	Heat sink	L96978-001
(18)	Fan	L23189-001
(19)	Battery (3 cell, 41 Whr)	L11119-855

Table 3-1 Computer major components and their descriptions (continued)

Item	Component	Spare part number
(20)	Bottom cover	L96975-001
(21)	Rubber feet	L96981-001

Display assembly subcomponents

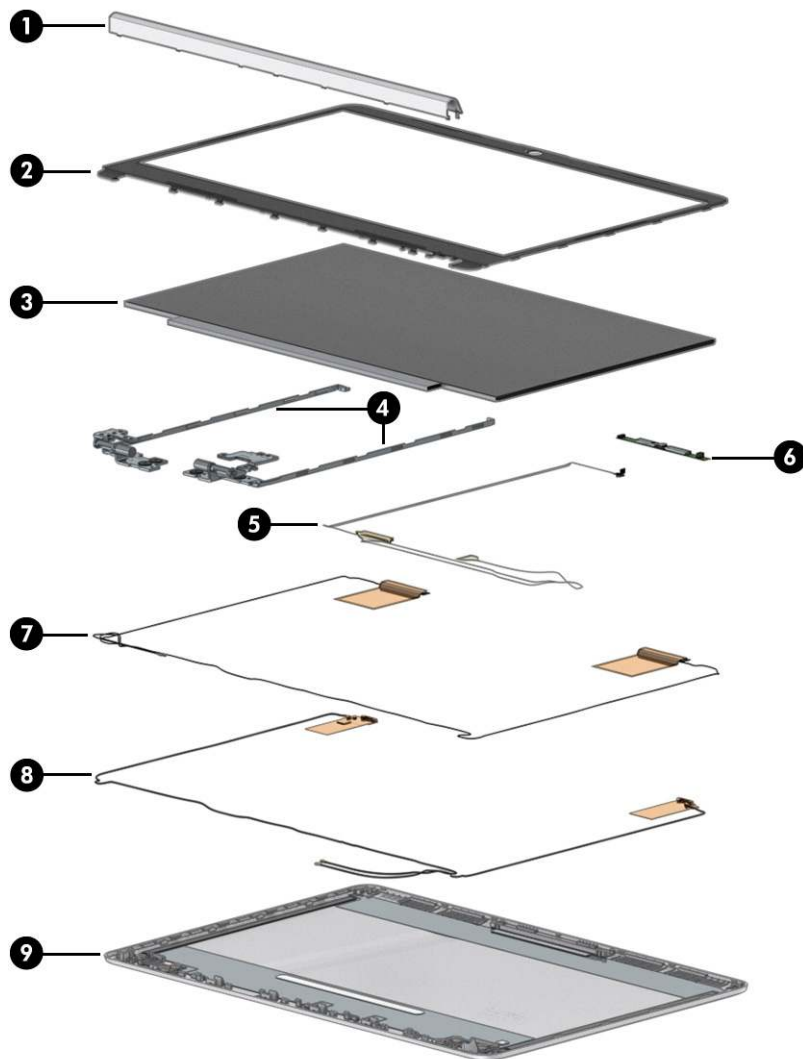
**Table 3-2 Display components and their descriptions**

Item	Component	Spare part number
(1)	Hinge cover	L96980-001
(2)	Display bezel	L96976-001
(3)	Display panel (includes stretchable adhesive)	L96988-001
(4)	Display hinges (left and right; includes stretchable adhesive)	L96979-001
(5)	Display panel cable (includes stretchable adhesive)	L96977-001

Table 3-2 Display components and their descriptions (continued)

Item	Component	Spare part number
(6)	Webcam/microphone module	L23237-001
	Wireless antennas (includes stretchable adhesive)	
(7)	WLAN antennas	L96970-001
(7) (8)	WLAN + WWAN antennas	L96972-001
(9)	Display back cover	L96974-001

Miscellaneous parts

Table 3-3 Miscellaneous parts and their descriptions

Component	Spare part number
AC adapter (65 W, PFC, slim, 4.5 mm)	913691-850
Power cord (C5, 1.0 m)	L19363-001
SIM tray	L98514-001
System board hook	L88007-001
HDMI-to-VGA adapter	701943-001
Screw Kit	L24494-001

4 Removal and replacement procedures preliminary requirements

Tools required

You need the following tools to complete the removal and replacement procedures:

- Nonmarking, nonconductive pry tool
- Magnetic Phillips P1 screwdriver
- Tweezers

Service considerations

The following sections include some of the considerations that you must keep in mind during disassembly and assembly procedures.

 **NOTE:** As you remove each subassembly from the computer, place the subassembly (and all accompanying screws) away from the work area to prevent damage.

Plastic parts

 **IMPORTANT:** Using excessive force during disassembly and reassembly can damage plastic parts.

Cables and connectors

 **IMPORTANT:** When servicing the computer, be sure that cables are placed in their proper locations during the reassembly process. Improper cable placement can damage the computer.

Cables must be handled with extreme care to avoid damage. Apply only the tension required to unseat or seat the cables during removal and insertion. Handle cables by the connector whenever possible. In all cases, avoid bending, twisting, or tearing cables. Be sure that cables are routed in such a way that they cannot be caught or snagged by parts being removed or replaced. Handle flex cables with extreme care; these cables tear easily.

Drive handling



IMPORTANT: Drives are fragile components that must be handled with care. To prevent damage to the computer, damage to a drive, or loss of information, observe these precautions:

Before removing or inserting a hard drive, shut down the computer. If you are unsure whether the computer is off or in Hibernation, turn the computer on, and then shut it down through the operating system.

Before handling a drive, be sure that you are discharged of static electricity. While handling a drive, avoid touching the connector.

Before removing an optical drive, be sure that a disc is not in the drive and be sure that the optical drive tray is closed.

Handle drives on surfaces covered with at least 2.54 cm (1 inch) of shock-proof foam.

Avoid dropping drives from any height onto any surface.

After removing a hard drive or an optical drive, place it in a static-proof bag.

Avoid exposing an internal hard drive to products that have magnetic fields, such as monitors or speakers.

Avoid exposing a drive to temperature extremes or liquids.

If a drive must be mailed, place the drive in a bubble pack mailer or other suitable form of protective packaging and label the package “FRAGILE.”

Workstation guidelines

Follow these grounding workstation guidelines:

- Cover the workstation with approved static-shielding material.
- Use a wrist strap connected to a properly grounded work surface and use properly grounded tools and equipment.
- Use conductive field service tools, such as cutters, screw drivers, and vacuums.
- When fixtures must directly contact dissipative surfaces, use fixtures made only of static-safe materials.
- Keep the work area free of nonconductive materials, such as ordinary plastic assembly aids and polystyrene foam.
- Handle ESD-sensitive components, parts, and assemblies by the case or PCM laminate. Handle these items only at static-free workstations.
- Avoid contact with pins, leads, or circuitry.
- Turn off power and input signals before inserting or removing connectors or test equipment.

Electrostatic discharge information

A sudden discharge of static electricity from your finger or other conductor can destroy static-sensitive devices or microcircuitry. Often the spark is neither felt nor heard, but damage occurs. An electronic device exposed to electrostatic discharge (ESD) might not appear to be affected at all and can work perfectly throughout a normal cycle. The device might function normally for a while, but it has been degraded in the internal layers, reducing its life expectancy.

Networks built into many integrated circuits provide some protection, but in many cases, the discharge contains enough power to alter device parameters or melt silicon junctions.



IMPORTANT: To prevent damage to the device when you are removing or installing internal components, observe these precautions:

Keep components in their electrostatic-safe containers until you are ready to install them.

Before touching an electronic component, discharge static electricity by using the guidelines described in this section.

Avoid touching pins, leads, and circuitry. Handle electronic components as little as possible.

If you remove a component, place it in an electrostatic-safe container.

Generating static electricity

Note the following:

- Different activities generate different amounts of static electricity.
- Static electricity increases as humidity decreases.

Table 4-1 Static electricity occurrence based on activity and humidity

Event	Relative humidity		
	55%	40%	10%
Walking across carpet	7,500 V	15,000 V	35,000 V
Walking across vinyl floor	3,000 V	5,000 V	12,000 V
Motions of bench worker	400 V	800 V	6,000 V
Removing DIPs from plastic tube	400 V	700 V	2,000 V
Removing DIPs from vinyl tray	2,000 V	4,000 V	11,500 V
Removing DIPs from polystyrene foam	3,500 V	5,000 V	14,500 V
Removing bubble pack from PCB	7,000 V	20,000 V	26,500 V
Packing PCBs in foam-lined box	5,000 V	11,000 V	21,000 V

Electronic components can be packaged together in plastic tubes, trays, or polystyrene foam.



NOTE: As little as 700 V can degrade a product.

Preventing electrostatic damage to equipment

Many electronic components are sensitive to ESD. Circuitry design and structure determine the degree of sensitivity. The following packaging and grounding precautions are necessary to prevent static electricity damage to electronic components.

- To avoid hand contact, transport products in static-safe containers such as tubes, bags, or boxes.
- Protect all electrostatic parts and assemblies with conductive or approved containers or packaging.
- Keep electrostatic-sensitive parts in their containers until they arrive at static-free stations.
- Place items on a grounded surface before removing them from their container.
- Always be properly grounded when touching a sensitive component or assembly.

- Avoid contact with pins, leads, or circuitry.
- Place reusable electrostatic-sensitive parts from assemblies in protective packaging or conductive foam.

Personal grounding methods and equipment

Use the following equipment to prevent static electricity damage to electronic components:

- **Wrist straps** are flexible straps with a maximum of $1\text{ M}\Omega \pm 10\%$ resistance in the ground cords. To provide proper ground, a strap must be worn snug against bare skin. The ground cord must be connected and fit snugly into the banana plug connector on the grounding mat or workstation.
- **Heel straps/Toe straps/Boot straps** can be used at standing workstations and are compatible with most types of shoes or boots. On conductive floors or dissipative floor mats, use them on both feet with a maximum of $1\text{ M}\Omega \pm 10\%$ resistance between the operator and ground.

Table 4-2 Static shielding protection levels

Static shielding protection levels	
Method	Voltage
Antistatic plastic	1,500
Carbon-loaded plastic	7,500
Metallized laminate	15,000

Grounding the work area

To prevent static damage at the work area, take the following precautions:

- Cover the work surface with approved static-dissipative material. Provide a wrist strap connected to the work surface and properly grounded tools and equipment.
- Use static-dissipative mats, foot straps, or air ionizers to give added protection.
- Handle electrostatic sensitive components, parts, and assemblies by the case or PCB laminate. Handle them only at static-free work areas.
- Turn off power and input signals before inserting and removing connectors or test equipment.
- Use fixtures made of static-safe materials when fixtures must directly contact dissipative surfaces.
- Keep work area free of nonconductive materials such as ordinary plastic assembly aids and polystyrene foam.
- Use field service tools, such as cutters, screwdrivers, and vacuums, that are conductive.

Recommended materials and equipment

HP recommends the following materials and equipment to prevent static electricity:

- Antistatic tape
- Antistatic smocks, aprons, or sleeve protectors
- Conductive bins and other assembly or soldering aids
- Conductive foam
- Conductive tabletop workstations with ground cord of $1\text{ M}\Omega \pm 10\%$ resistance

- Static-dissipative table or floor mats with hard tie to ground
- Field service kits
- Static awareness labels
- Wrist straps and footwear straps providing $1\text{ M}\Omega \pm 10\%$ resistance
- Material handling packages
- Conductive plastic bags
- Conductive plastic tubes
- Conductive tote boxes
- Opaque shielding bags
- Transparent metallized shielding bags
- Transparent shielding tubes

Packaging and transporting guidelines

Follow these grounding guidelines when packaging and transporting equipment:

- To avoid hand contact, transport products in static-safe tubes, bags, or boxes.
- Protect ESD-sensitive parts and assemblies with conductive or approved containers or packaging.
- Keep ESD-sensitive parts in their containers until the parts arrive at static-free workstations.
- Place items on a grounded surface before removing items from their containers.
- Always be properly grounded when touching a component or assembly.
- Store reusable ESD-sensitive parts from assemblies in protective packaging or nonconductive foam.
- Use transporters and conveyors made of antistatic belts and roller bushings. Be sure that mechanized equipment used for moving materials is wired to ground and that proper materials are selected to avoid static charging. When grounding is not possible, use an ionizer to dissipate electric charges.

5 Removal and replacement procedures for authorized service provider parts

 **IMPORTANT:** Components described in this chapter should be accessed only by an authorized service provider. Accessing these parts can damage the computer or void the warranty.

 **NOTE:** HP continually improves and changes product parts. For complete and current information about supported parts for your computer, go to <http://partsurfer.hp.com>, select your country or region, and then follow the on-screen instructions.

Component replacement procedures

There are as many as 52 screws that must be removed, replaced, or loosened when servicing the computer. Make special note of each screw size and location during removal and replacement.

Preparation for disassembly

See [Removal and replacement procedures preliminary requirements on page 17](#) for initial safety procedures.

1. Turn off the computer. If you are unsure whether the computer is off or in Hibernation, turn the computer on, and then shut it down through the operating system.
2. Disconnect the power from the computer by unplugging the power cord from the computer.
3. Disconnect all external devices from the computer.

Bottom cover

Table 5-1 Bottom cover descriptions and part numbers

Description	Spare part number
Bottom cover	L96975-001
Rubber feet	L96981-001
SIM tray	L98514-001

Before removing the bottom cover, follow this step:

- ▲ Prepare the computer for disassembly ([Preparation for disassembly on page 22](#)).

Remove the bottom cover:

1. Peel the two rubber feet off the bottom cover.

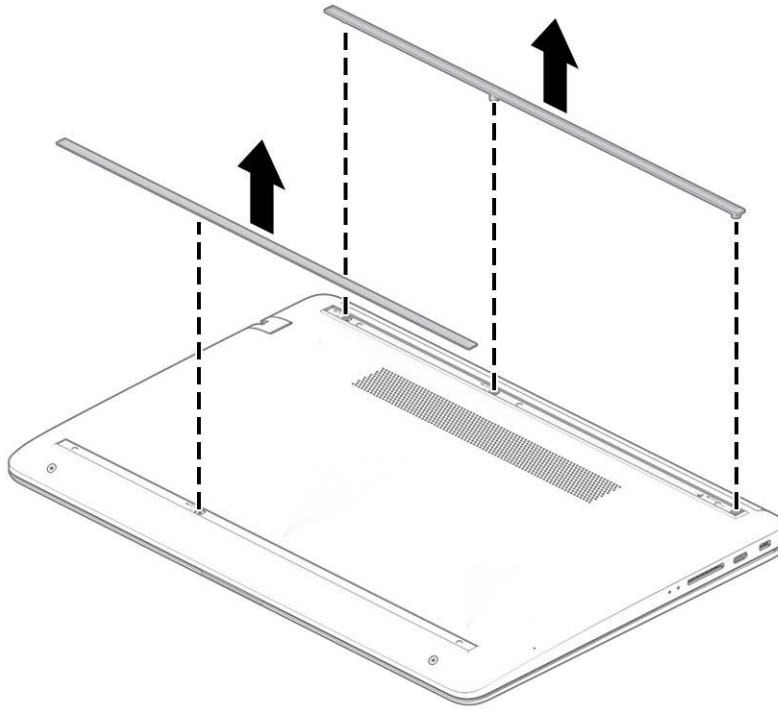

2. Remove the SIM holder from the computer **(1)**.
3. Remove the four Phillips M2.5 × 6.0 screws **(2)** from the bottom cover.

4. Remove the two Phillips M2.5 × 4.0 screws **(3)** from the bottom cover.

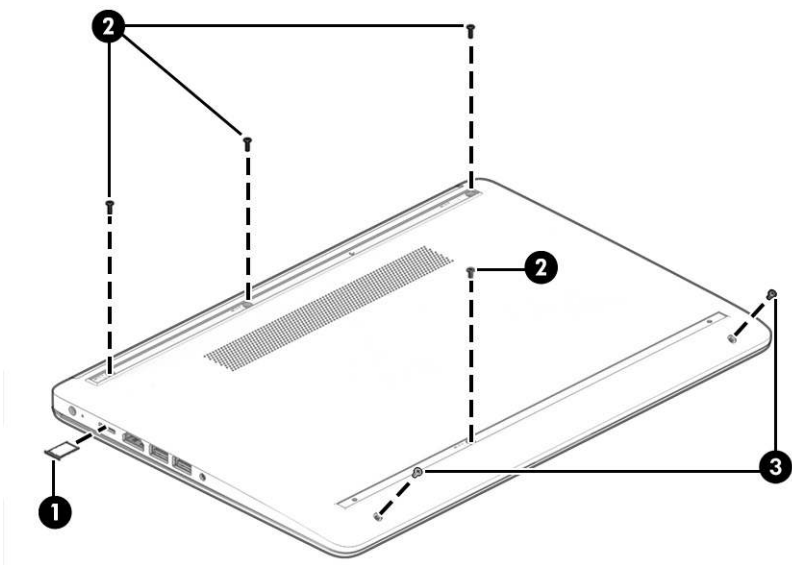

5. Insert a plastic tool between the bottom cover and the computer chassis **(1)**, and then flex and lift the bottom of the bottom cover enough to separate it from the computer **(2)**.



Reverse this procedure to install the bottom cover.

Battery

Table 5-2 Battery description and part number

Description	Spare part number
Battery, 3 cell, 41 Whr	L11119-855

Before removing the battery, follow these steps:

1. Prepare the computer for disassembly ([Preparation for disassembly on page 22](#)).
2. Remove the bottom cover (see [Bottom cover on page 23](#)).

Remove the battery:

1. Remove the four Phillips M2.0 × 3.5 screws **(1)** that secure the battery to the computer.
2. Lift the top of the battery up **(2)**, and then remove the battery from the computer **(3)**.

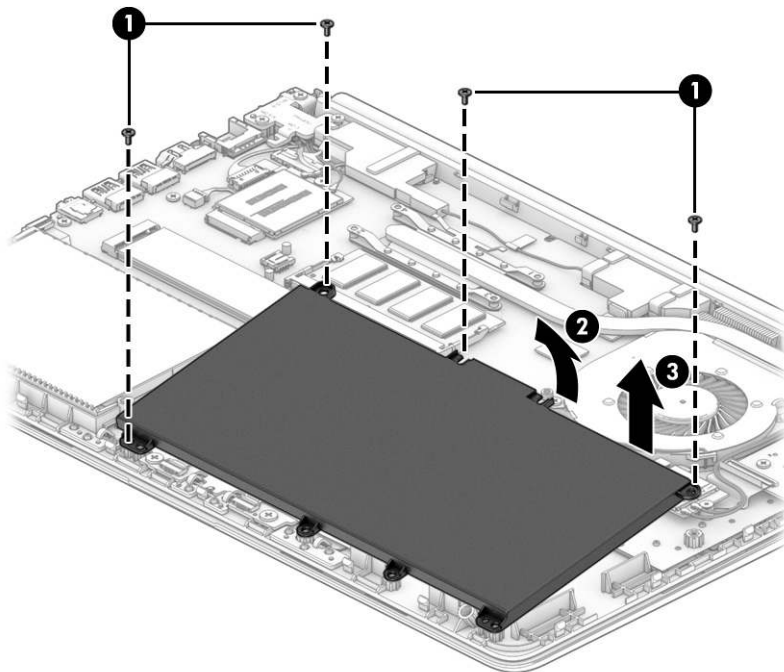

Reverse this procedure to install the battery.

Memory module

Table 5-3 Memory descriptions and part numbers

Description	Spare part number
Memory module, 8 GB	937236-855
Memory module, 4 GB	L10598-855

Before removing the memory modules, follow these steps:

1. Prepare the computer for disassembly ([Preparation for disassembly on page 22](#)).
2. Remove the bottom cover (see [Bottom cover on page 23](#)).
3. Remove the battery (see [Battery on page 25](#)).

Remove the memory modules:

1. Spread the two retention clips outward **(1)** until the memory module tilts up at a 45° angle.
2. Grasp the edge of the memory module **(2)**, and then gently pull the module out of the slot. Use the same procedure to remove both memory modules.

 **IMPORTANT:** To prevent damage to the memory module, hold the memory module by the edges only. Do not touch the components on the memory module.

To protect a memory module after removal, place it in an electrostatic-safe container.

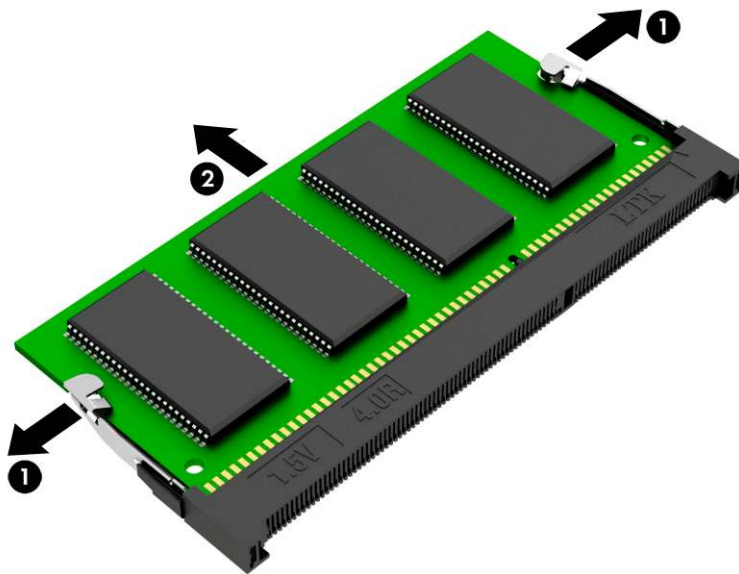

 **IMPORTANT:** To prevent damage to the memory module, hold the memory module by the edges only. Do not touch the components on the memory module. Do not bend the memory module.

1. Align the notched edge of the memory module with the tab in the memory module slot **(1)**.
2. Press the module into the slot until seated **(2)**.

-
-
3. Gently press down on the module edges until the side retention clips snap into place **(3)**.

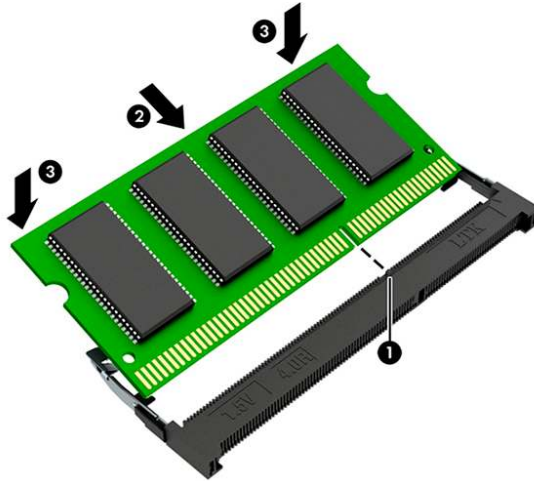

Solid-state drive

Table 5-4 Solid-state drive descriptions and part numbers

Description	Spare part number
256 GB, PCIe, TLC	L85354-005
Solid-state drive board	L24487-001

Before removing the solid-state drive, follow these steps:

1. Prepare the computer for disassembly ([Preparation for disassembly on page 22](#)).
2. Remove the bottom cover (see [Bottom cover on page 23](#)).
3. Remove the battery (see [Battery on page 25](#)).

Remove the solid-state drive:

- ▲ Remove the Phillips M2.0 × 2.0 screw **(1)**, and then pull the drive from the socket **(2)**.

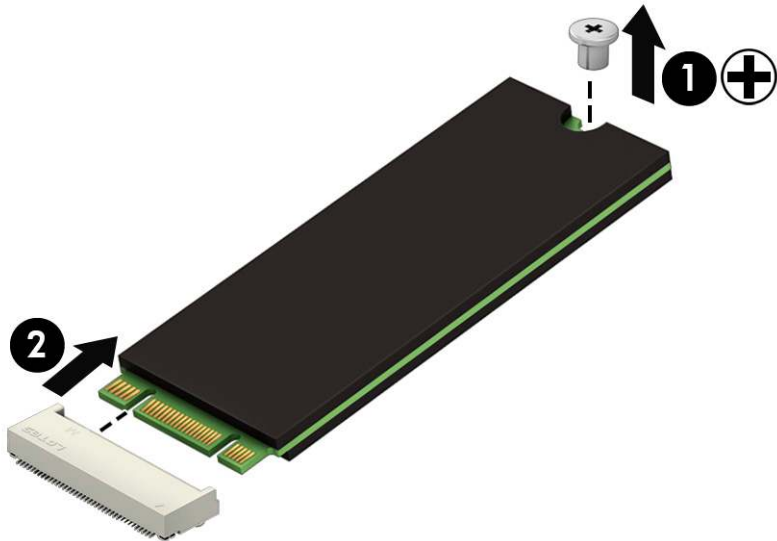

Reverse this procedure to install the solid-state drive.

Hard drive



NOTE: The hard drive spare part kit does not include the hard drive cover or connector.

Description	Spare part number
Hard drive, 1 TB, 5400 rpm, 7 mm	762990-005
Hard drive cable	L23187-001
Hard drive cover	L24490-001

Before removing the hard drive, follow these steps:

1. Prepare the computer for disassembly ([Preparation for disassembly on page 22](#)).
2. Remove the bottom cover (see [Bottom cover on page 23](#)).
3. Remove the battery (see [Battery on page 25](#)).

To remove the hard drive:

1. Disconnect the cable **(1)** from the system board ZIF connector.
2. Lift the front of the hard drive **(2)**, and then remove it from the computer **(3)**.

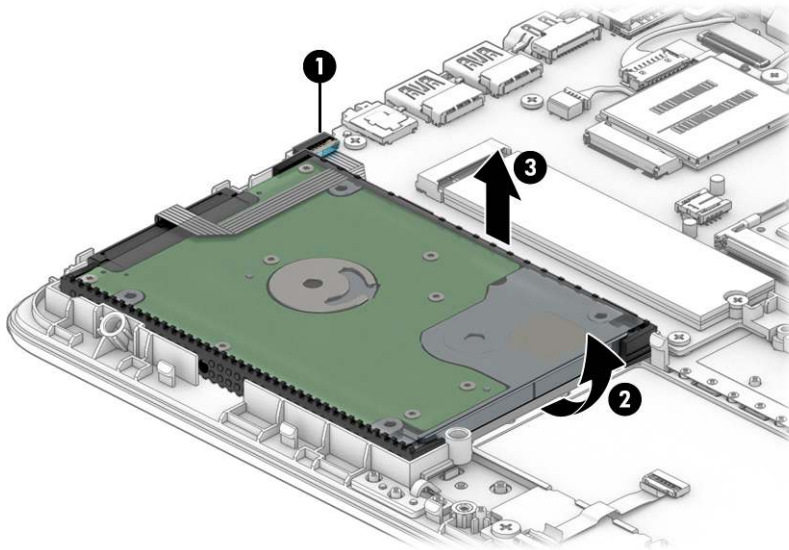

3. To remove the hard drive cover, pull the sides **(1)** up and away from the hard drive, and then remove the cover **(2)**.

4. To remove the hard drive connector, pull the connector **(3)** away from the hard drive.

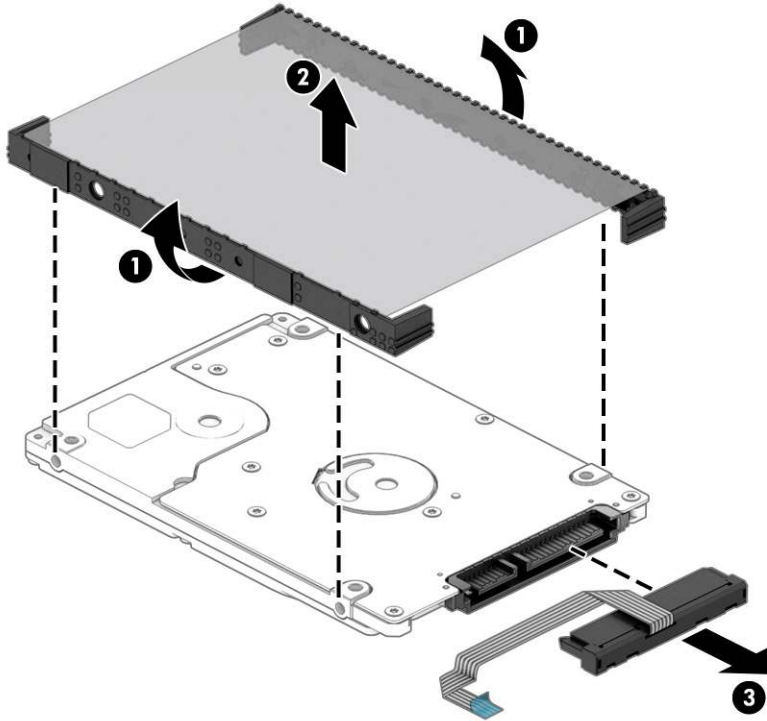

Reverse this procedure to reassemble and install the hard drive.

WLAN module

Table 5-5 WLAN module description and part number

Description	Spare part number
Realtek RTL8822CE 802.11ac 2 × 2 Wi-Fi + Bluetooth 5.0	L44796-005
Intel Wi-Fi 6 AX201 + Bluetooth 5 (non-vPro) (802.11ax 2 × 2)	L57250-005

 **IMPORTANT:** To prevent an unresponsive system, replace the wireless module only with a wireless module authorized for use in the computer by the governmental agency that regulates wireless devices in your country or region. If you replace the module and then receive a warning message, remove the module to restore device functionality, and then contact technical support.

Before removing the WLAN module, follow these steps:

1. Prepare the computer for disassembly ([Preparation for disassembly on page 22](#)).
2. Remove the bottom cover (see [Bottom cover on page 23](#)).
3. Remove the battery (see [Battery on page 25](#)).

Remove the WLAN module:

1. Disconnect the WLAN antenna cables (**1**) from the terminals on the WLAN module.

 **NOTE:** The WLAN antenna cable labeled **1** connects to the WLAN module **Main** terminal labeled **1**. The WLAN antenna cable labeled **2** connects to the WLAN module **Aux** terminal labeled **2**.

2. Remove the Phillips M2.0 × 2.0 screw (**2**) that secures the WLAN module to the bottom cover. (The WLAN module tilts up.)
3. Remove the WLAN module (**3**) by pulling the module away from the slot at an angle.

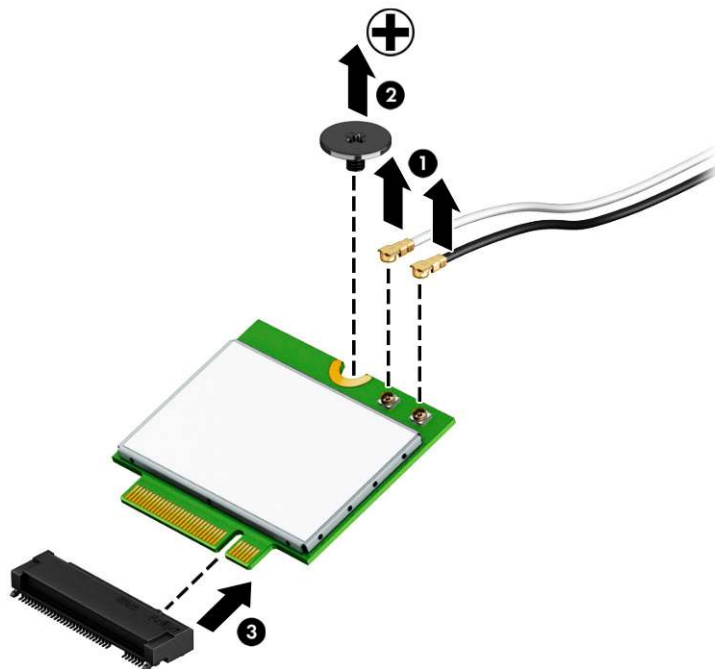

 **NOTE:** If the WLAN antenna is not connected to the terminal on the WLAN module, a protective sleeve must be installed on the antenna connector, as shown in the following illustration.

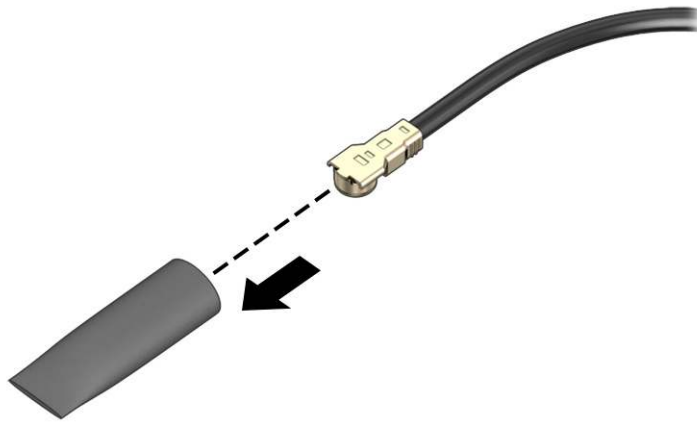

Reverse this procedure to install the WLAN module.

WWAN module

Table 5-6 WLAN module description and part number

Description	Spare part number
Intel XMM 7360 LTE-Advanced (CAT 9)	L70670-005

 **IMPORTANT:** To prevent an unresponsive system, replace the wireless module only with a wireless module authorized for use in the computer by the governmental agency that regulates wireless devices in your country or region. If you replace the module and then receive a warning message, remove the module to restore device functionality, and then contact technical support.

Before removing the WWAN module, follow these steps:

1. Prepare the computer for disassembly ([Preparation for disassembly on page 22](#)).
2. Remove the bottom cover (see [Bottom cover on page 23](#)).
3. Remove the battery (see [Battery on page 25](#)).

Remove the WWAN module:

1. Disconnect the WWAN antenna cables (**1**) from the terminals on the WWAN module.

 **NOTE:** The red WWAN antenna cable is connected to the WWAN module **Main** terminal. The blue WWAN antenna cable is connected to the WWAN module **Aux** terminal.

2. Remove the Phillips M2.0 × 2.0 screw (**2**) that secures the WWAN module to the bottom cover. (The WWAN module tilts up.)

3. Remove the WWAN module (3) by pulling the module away from the slot at an angle.

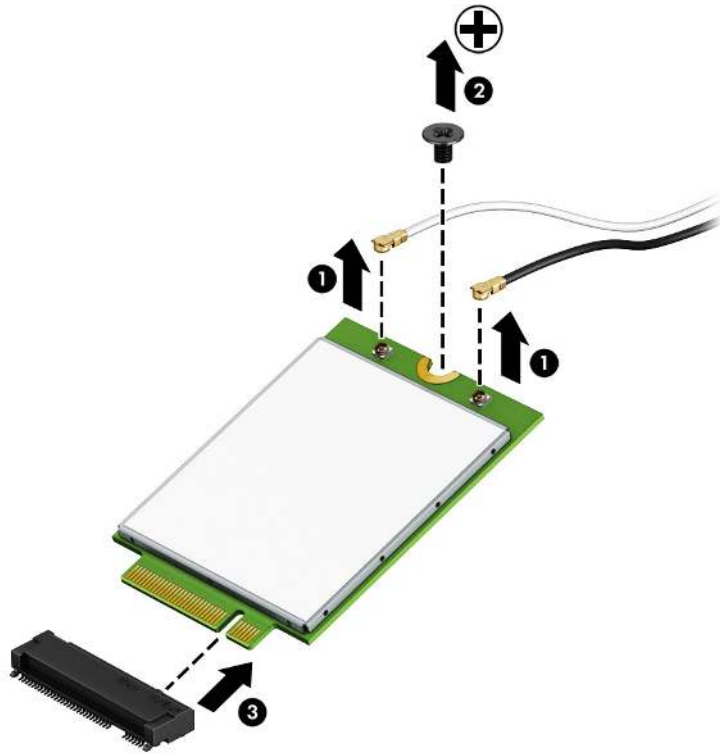

 **NOTE:** If the WWAN antenna is not connected to the terminal on the WWAN module, a protective sleeve must be installed on the antenna connector, as shown in the following illustration.

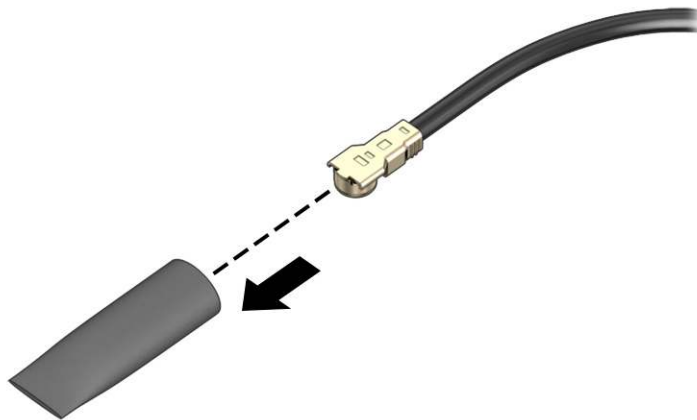

Reverse this procedure to install the WWAN module.

USB, card reader, and power button board

Table 5-7 USB, card reader, and power button board description and part number

Description	Spare part number
USB, card reader, and power button board	M05045-001
NOTE: The USB, card reader, and power button board spare part kit does not include the cable. The cable is available as spare part number L23186-001.	

Before removing the USB, card reader, and power button board, follow these steps:

1. Prepare the computer for disassembly ([Preparation for disassembly on page 22](#)).
2. Remove the bottom cover (see [Bottom cover on page 23](#)).
3. Remove the battery (see [Battery on page 25](#)).

Remove the USB, card reader, and power button board:

1. Disconnect the cable from the ZIF connector on the board (**1**).
2. Remove the two Phillips M2.0 × 3.0 screws (**2**) that secure the board to the computer.
3. Move the antenna cable that routes across the board (**3**).
4. Remove the board from the computer (**4**).

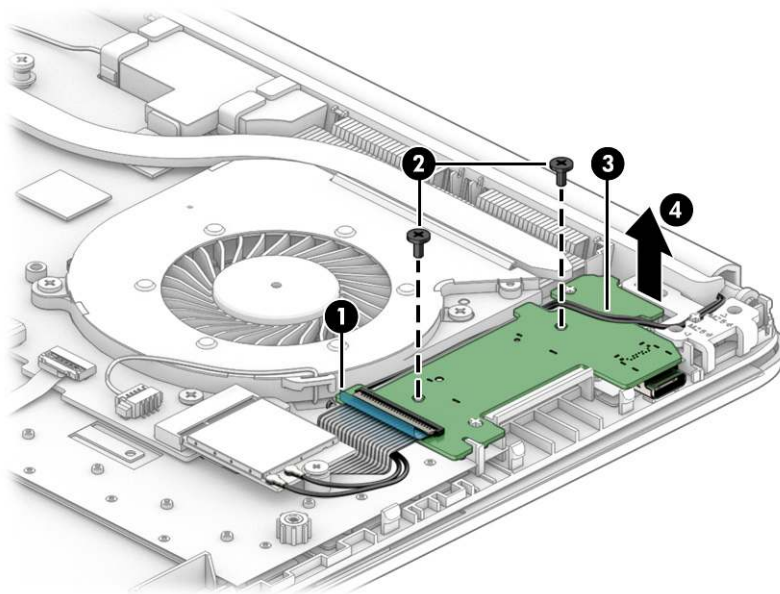

Reverse this procedure to install the USB, card reader, and power button board.

Speaker assembly

Table 5-8 Speaker assembly description and part number

Description	Spare part number
Speaker assembly	L24489-001

Before removing the speaker assembly, follow these steps:

1. Prepare the computer for disassembly ([Preparation for disassembly on page 22](#)).
2. Remove the bottom cover (see [Bottom cover on page 23](#)).
3. Remove the battery (see [Battery on page 25](#)).

Remove the speakers:

1. Disconnect the speaker cable from the system board **(1)**.
2. Release the tape that secures the cable to the system board **(2)**.
3. Remove the speakers from the computer **(3)**.

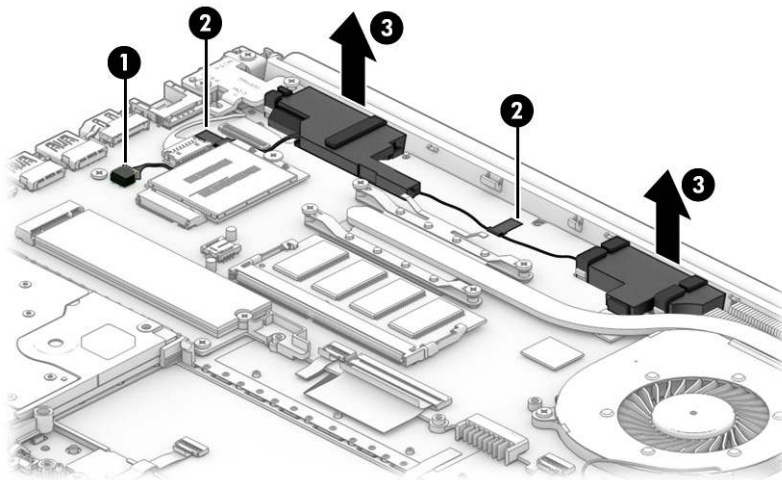

Reverse this procedure to install the speaker assembly.

Power connector

Table 5-9 Power connector description and part number

Description	Spare part number
Power connector	L23188-001

Before removing the power connector cable, follow these steps:

1. Prepare the computer for disassembly ([Preparation for disassembly on page 22](#)).
2. Remove the bottom cover (see [Bottom cover on page 23](#)).
3. Remove the battery (see [Battery on page 25](#)).

Remove the power connector cable:

1. Remove the three Phillips M2.5 × 6.0 screws from the display hinge (1), and then rotate the hinge to the upright position (2).

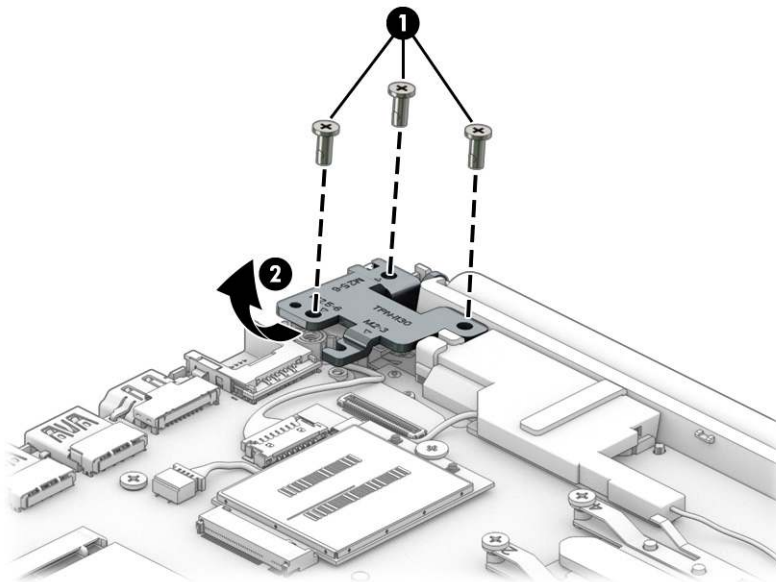

2. Disconnect the cable from the system board (1).

3. Remove the cable from the computer (2).

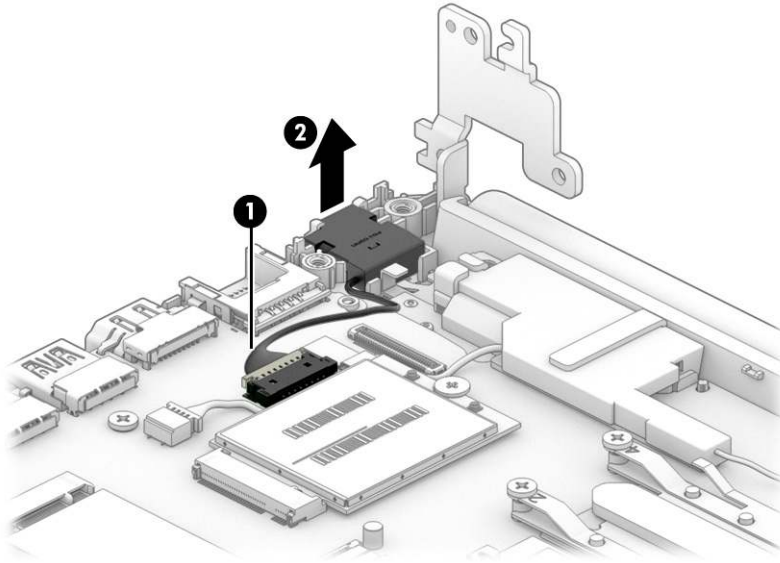

Reverse this procedure to install the power connector cable.

Touchpad click board

Table 5-10 Touchpad click board description and part number

Description	Spare part number
Touchpad click board	M05046-001

NOTE: The touchpad click board spare part kit does not include the cable. The cable is available as spare part number L24485-001.

Before removing the touchpad click board, follow these steps:

1. Prepare the computer for disassembly ([Preparation for disassembly on page 22](#)).
2. Remove the bottom cover (see [Bottom cover on page 23](#)).
3. Remove the battery (see [Battery on page 25](#)).

Remove the touchpad click board:

1. Disconnect the touchpad click board cable from the ZIF connector on the touchpad click board **(1)**.
2. Disconnect the touchpad board cable from the ZIF connector on the touchpad click board **(2)**.
3. Remove the two Phillips M2.0 × 2.0 screws **(3)** that secure the touchpad click board to the computer, and then remove the board **(4)**.

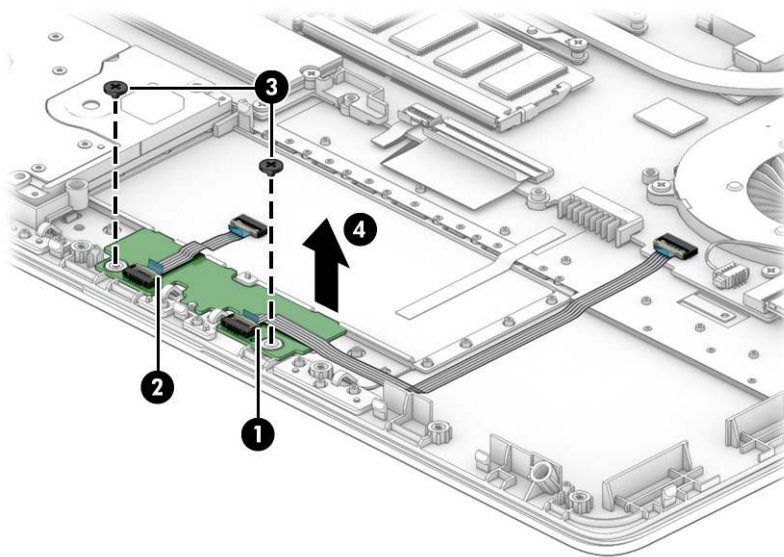

Reverse this procedure to install the touchpad click board.

Touchpad

Table 5-11 Touchpad description and part number

Description	Spare part number
Touchpad (includes gasket)	L24484-001

NOTE: The touchpad spare part kit does not include the cable. The cable is available as spare part number L23184-001.

Before removing the touchpad, follow these steps:

1. Prepare the computer for disassembly ([Preparation for disassembly on page 22](#)).
2. Remove the bottom cover (see [Bottom cover on page 23](#)).
3. Remove the battery (see [Battery on page 25](#)).

Remove the touchpad:

1. Remove the tape that secures the touchpad to the computer **(1)**.
2. Disconnect the touchpad board cable from the ZIF connector on the touchpad **(2)**.
3. Remove the touchpad from the computer **(3)**.

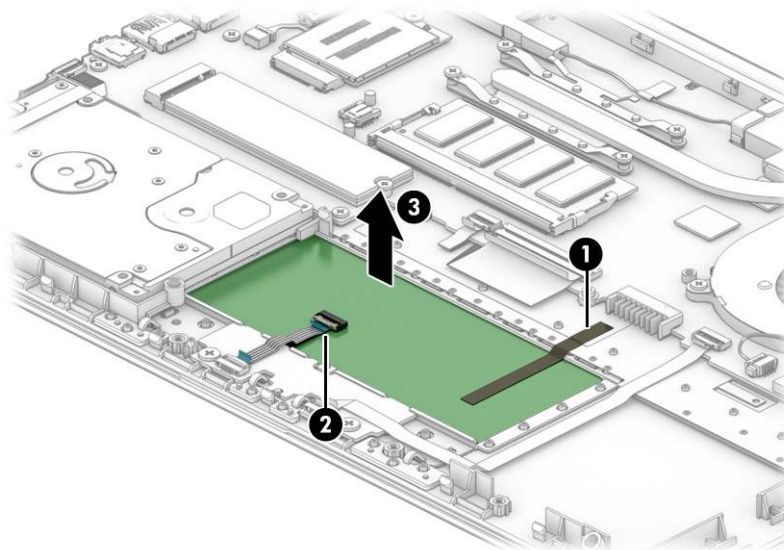

Reverse this procedure to install the touchpad.

Fan

Table 5-12 Fan description and part number

Description	Spare part number
Fan	L23189-001

Before removing the fan, follow these steps:

1. Prepare the computer for disassembly ([Preparation for disassembly on page 22](#)).
2. Remove the bottom cover (see [Bottom cover on page 23](#)).
3. Remove the battery (see [Battery on page 25](#)).

Remove the fan:

1. Disconnect the fan cable from the system board **(1)**.
2. Remove the two Phillips M2.0 × 3.5 screws **(2)** that secure the fan to the computer.
3. Remove the fan from the computer **(3)**.

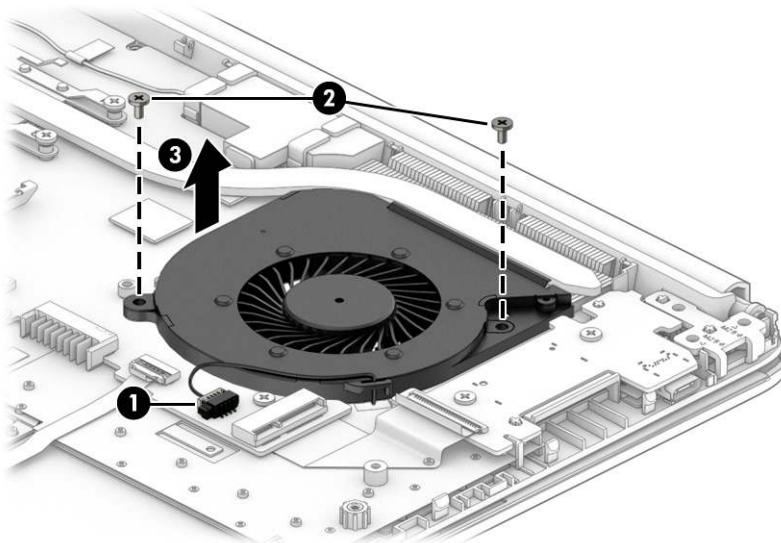

Reverse this procedure to install the fan.

Heat sink (thermal module)

Table 5-13 Heat sink assembly description and part number

Description	Spare part number
Heat sink	L96978-001

Before removing the heat sink, follow these steps:

1. Prepare the computer for disassembly ([Preparation for disassembly on page 22](#)).
2. Remove the bottom cover (see [Bottom cover on page 23](#)).
3. Remove the battery (see [Battery on page 25](#)).

Remove the heat sink:

1. Remove the four Phillips M2.0 × 3.5 screws **(1)** in the order indicated on the heat sink.
2. Remove the heat sink **(2)**.

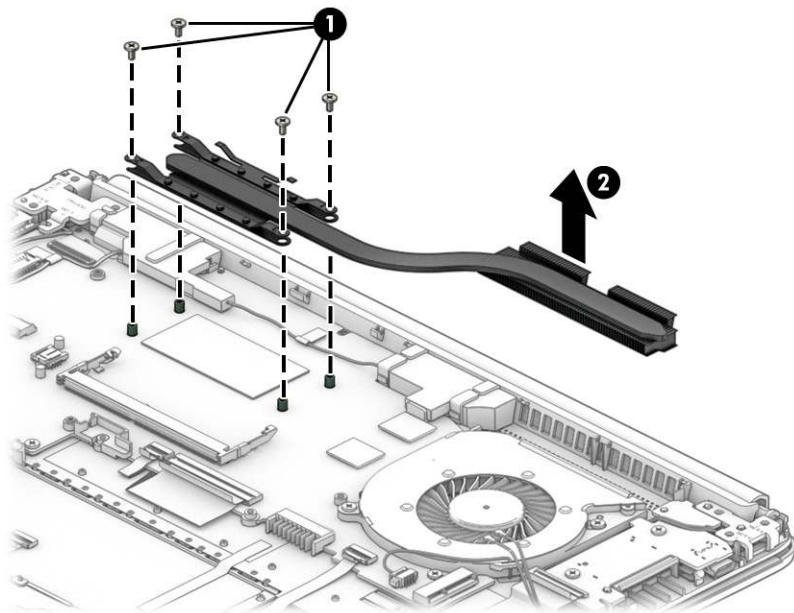

3. Apply thermal grease to the integrated processor on the system board (1) and associated location on the heat sink (2).

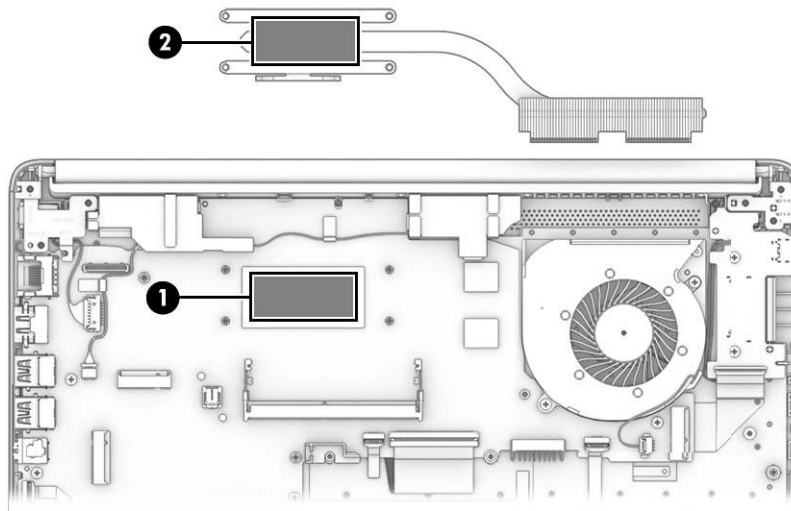

Reverse this procedure to install the heat sink.

System board

Table 5-14 System board descriptions and part numbers

Description	Spare part number
Intel Core i5-1035G1 processor for use in models with a non-Windows operating system	L96985-001
Intel Core i5-1035G1 processor for use in models with a Windows operating system	L96985-601
Intel Core i3-1005G1 processor for use in models with a non-Windows operating system	L96984-001
Intel Core i3-1005G1 processor for use in models with a Windows operating system	L96984-601

Before removing the system board, follow these steps:

1. Prepare the computer for disassembly ([Preparation for disassembly on page 22](#)).
2. Remove the bottom cover (see [Bottom cover on page 23](#)).
3. Remove the battery (see [Battery on page 25](#)).
4. Remove the fan (see [Fan on page 41](#)).
5. Remove the speakers (see [Speaker assembly on page 36](#)).

Remove the system board:

1. Disconnect the following cables from the system board:
 - Display cable **(1)**
 - WWAN antennas **(2)**
 - Power connector cable **(3)**
 - USB board cable (ZIF) **(4)**
 - Touchpad click board cable (ZIF) **(5)**
 - Keyboard cable (ZIF) **(6)**
 - Keyboard backlight cable (ZIF) **(7)**
 - Hard drive connector cable (ZIF) **(8)**

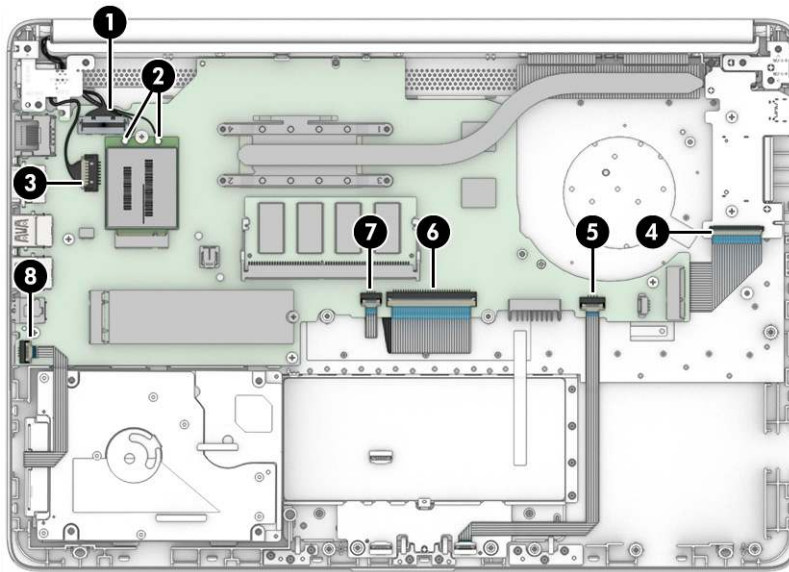

2. Remove the Phillips M2.0 × 3.5 screw **(1)** and the three Phillips M2.0 × 2.0 screws **(2)** that secure the system board to the computer.
3. Remove the system board from the computer **(3)**.

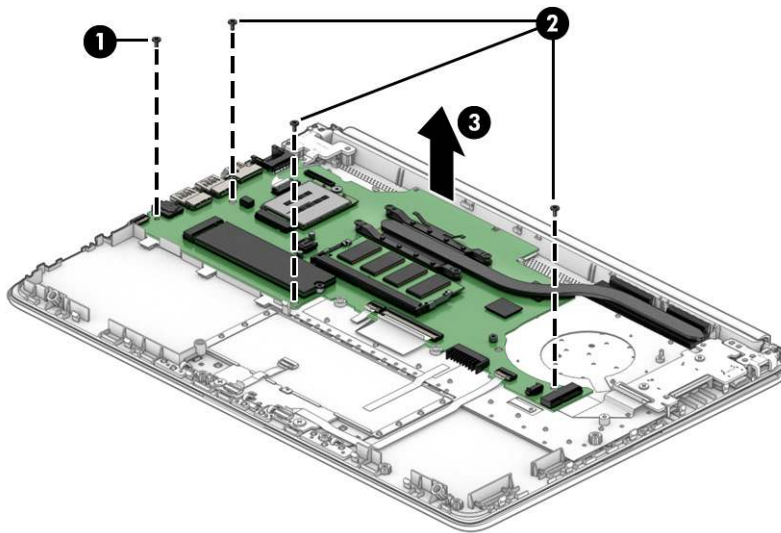

Reverse this procedure to install the system board.

Display assembly

 **NOTE:** Display assemblies are offered as spare parts only at a subcomponent level.

Before removing the display assembly, follow these steps:

1. Prepare the computer for disassembly ([Preparation for disassembly on page 22](#)).
2. Remove the bottom cover (see [Bottom cover on page 23](#)).
3. Remove the battery (see [Battery on page 25](#)).

Remove the display assembly:

1. Disconnect the display cable from the system board **(1)**.
2. Disconnect the antenna cables from the WWAN module **(2)**.
3. Disconnect the antenna cables from the WLAN module **(3)**, and then remove the cable from the routing path next to and over the USB, card reader, and power button board **(4)**.

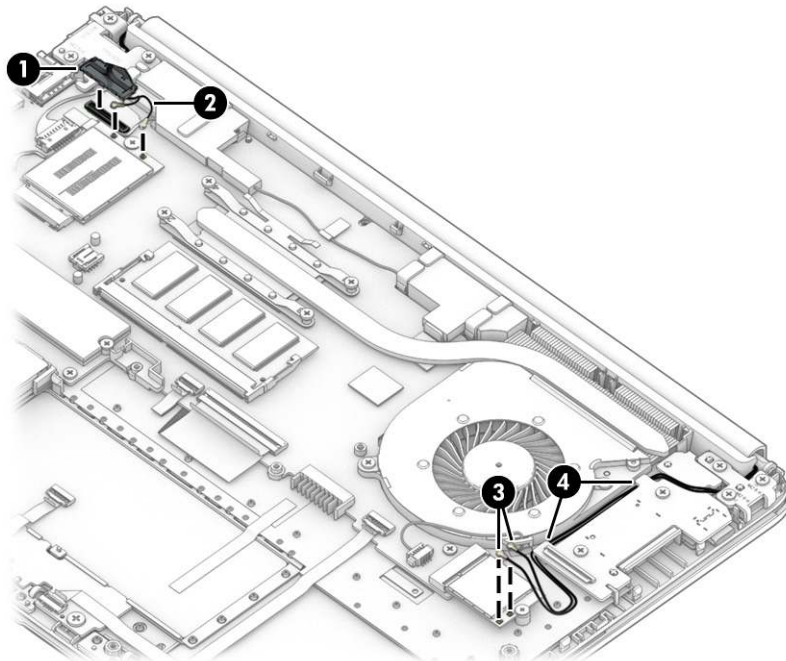

4. Open and position the computer with the display hanging off the table **(1)**.
5. Remove the five Phillips M2.5 × 6.0 screws **(2)** from the hinges.

6. Separate the display from the computer (3).

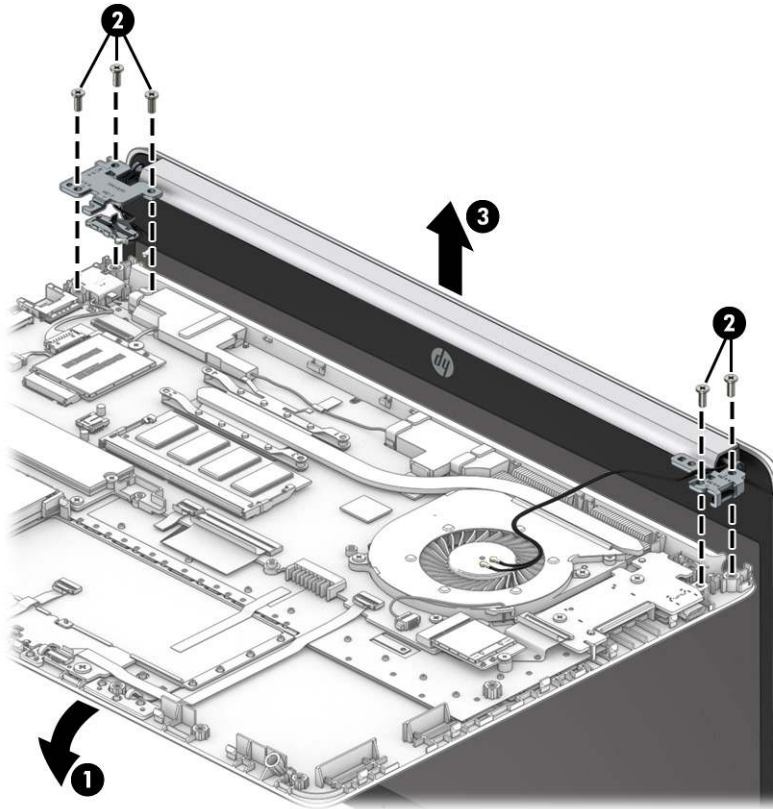

7. If it is necessary to replace display assembly subcomponents:
 - a. Remove the hinge cover by lifting it off the display.
The hinge cover is available as spare part number L96980-001.

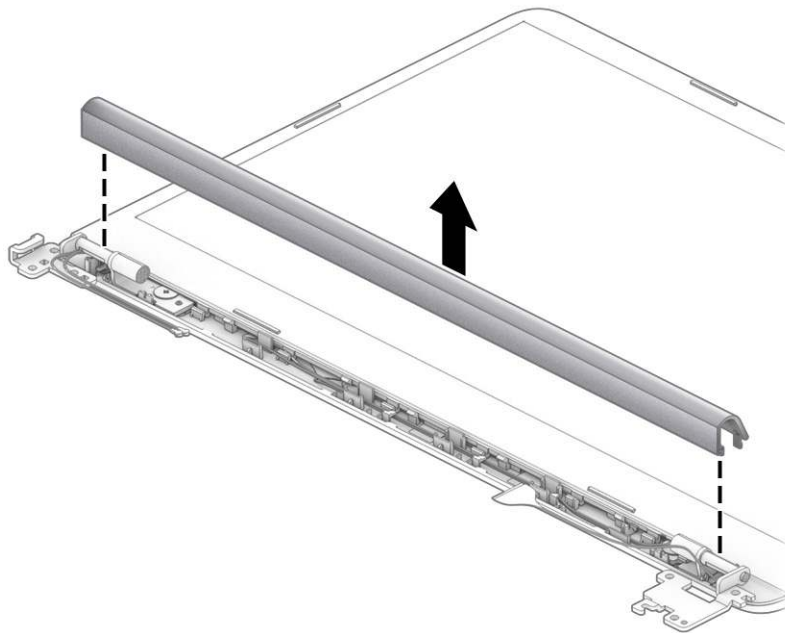

- b. Release the top edge of the display bezel **(1)** from the display assembly.



IMPORTANT: When removing the bezel, be careful not to bend or break the narrow sections of the bezel.

- c. Flex the inside of the top edge **(1)**, left and right sides **(2)**, and the inside of the bottom edge **(3)** of the display bezel until the bezel disengages from the display enclosure.
- d. Remove the display bezel from the display **(4)**.

The display bezel is available as spare part number L96976-001.

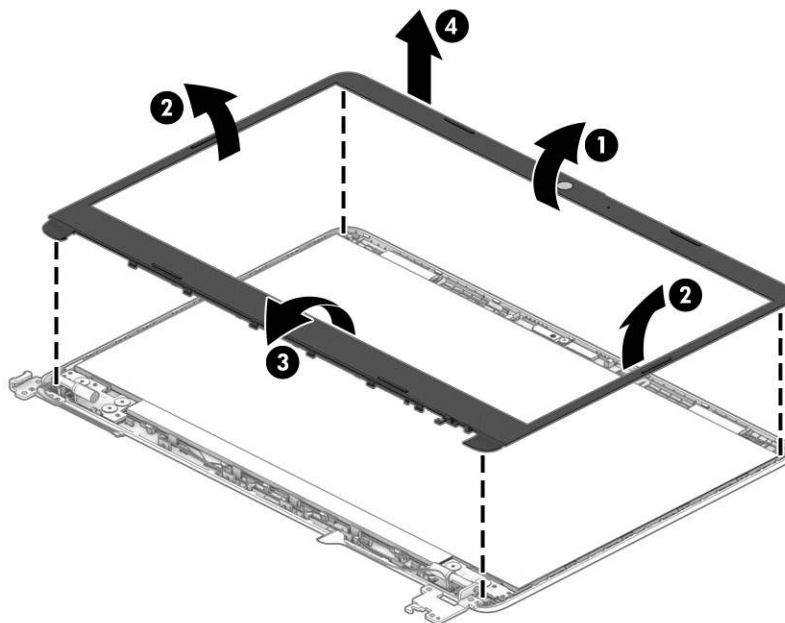

- 8. If it is necessary to remove the webcam module:
 - a. Lift the webcam module to disengage the adhesive that secures the module to the display **(1)**.

- c. Lift the top of the panel (4).

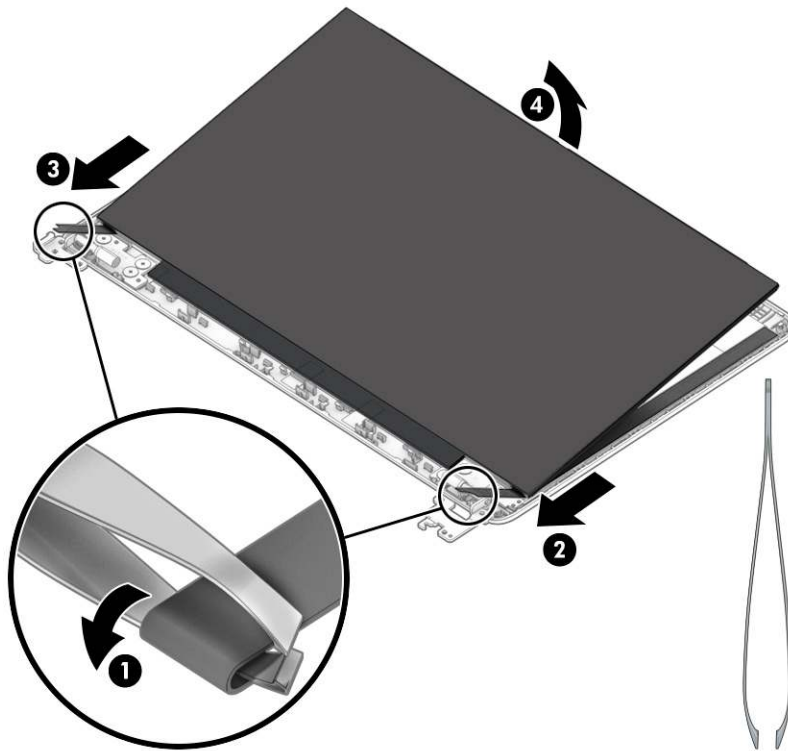

- d. Rotate the display panel over and place next to the display back cover (1).
- e. Lift the tape and locking lever from the connector on the rear of the panel (2), and then disconnect the cable from the panel (3).
- f. Remove the panel (4).

The display panel is available as spare part number L96988-001.

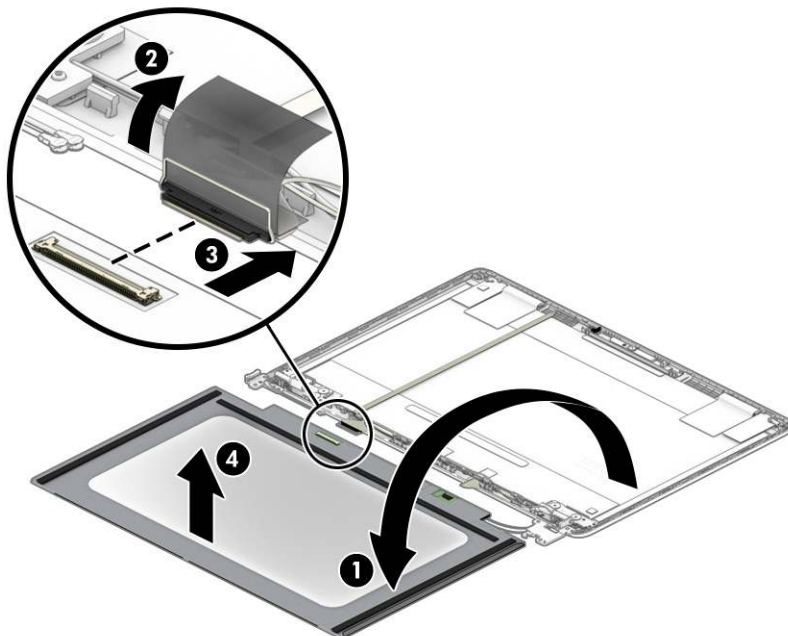

- 10.** If it is necessary to remove the display hinges:
- Remove the three Phillips M2.5 × 2.5 screws **(1)** from the bottom of each hinge.
 - Rotate the hinges upward **(2)**.
 - Remove the display hinges from the display back cover **(3)**.

The display hinges are available as spare part number L96979-001.

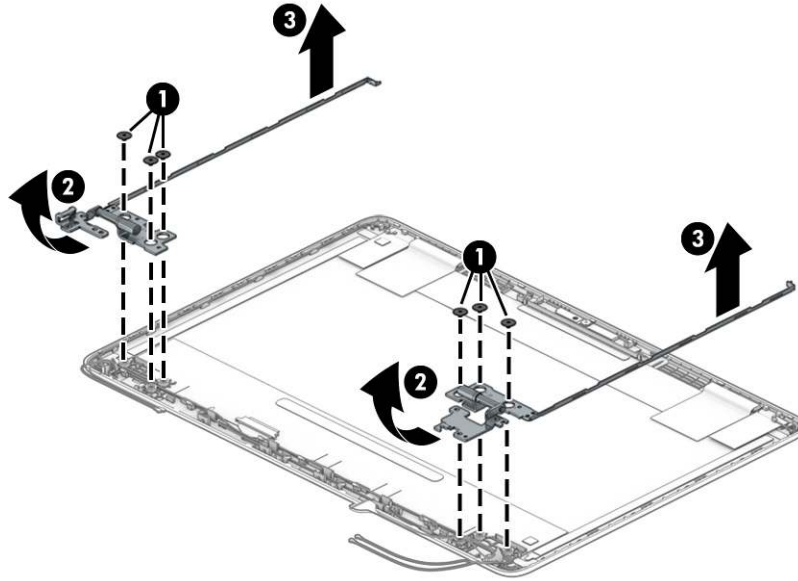

- 11.** If it is necessary to remove the display panel cable:
- ▲ Peel the cable off the inside of the display back cover **(1)**, and then remove the cable **(2)**.
- The display cable is available as spare part number L96977-001.

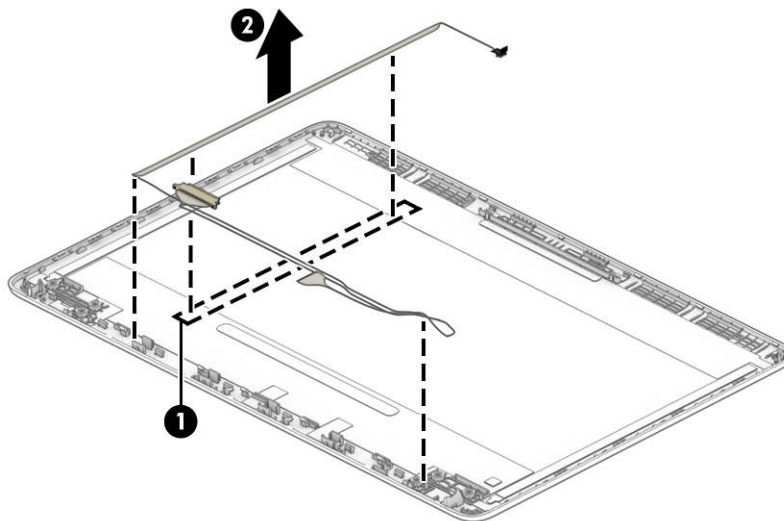

- 12.** If it is necessary to remove the WLAN antennas:
- Peel the antennas off the top of the display back cover **(1)**.

Top cover/keyboard

The top cover with keyboard remains after removing all other spare parts from the computer.

Table 5-15 Top cover/keyboard description and part number

Description	Spare part number
Top cover/keyboard; no backlight	L96982-001
Top cover/keyboard; backlit	L96983-001

6 Using Setup Utility (BIOS)

Setup Utility, or Basic Input/Output System (BIOS), controls communication between all the input and output devices on the system (such as disk drives, display, keyboard, mouse, and printer). Setup Utility (BIOS) includes settings for the types of devices installed, the startup sequence of the computer, and the amount of system and extended memory.

 **NOTE:** To start Setup Utility on convertible computers, your computer must be in notebook mode and you must use the keyboard attached to your notebook.

Starting Setup Utility (BIOS)

 **IMPORTANT:** Use extreme care when making changes in Setup Utility (BIOS). Errors can prevent the computer from operating properly.

▲ Turn on or restart the computer and quickly press **f10**.

– or –

Turn on or restart the computer, quickly press **esc**, and then press **f10** when the Start menu is displayed.

Updating Setup Utility (BIOS)

Updated versions of Setup Utility (BIOS) might be available on the HP website.

Most BIOS updates on the HP website are packaged in compressed files called *SoftPaqs*.

Some download packages contain a file named *Readme.txt*, which contains information regarding installing and troubleshooting the file.

Determining the BIOS version

To decide whether you need to update Setup Utility (BIOS), first determine the BIOS version on your computer.

To reveal the BIOS version information (also known as *ROM date* and *System BIOS*), use one of these options.

- HP Support Assistant
 1. Type `support` in the taskbar search box, and then select the **HP Support Assistant** app.

– or –

Select the question mark icon in the taskbar.

 2. Select **My notebook**, and then select **Specifications**.
- Setup Utility (BIOS)
 1. Start Setup Utility (BIOS) (see [Starting Setup Utility \(BIOS\) on page 54](#)).
 2. Select **Main**, and then make note of the BIOS version.
 3. Select **Exit**, select one of the options, and then follow the on-screen instructions.
- In Windows, press **ctrl+alt+s**.

To check for later BIOS versions, see [Downloading a BIOS update on page 55](#).

Downloading a BIOS update

 **IMPORTANT:** To reduce the risk of damage to the computer or an unsuccessful installation, download and install a BIOS update only when the computer is connected to reliable external power using the AC adapter. Do not download or install a BIOS update while the computer is running on battery power, docked in an optional docking device, or connected to an optional power source. During the download and installation, follow these instructions:

- Do not disconnect power from the computer by unplugging the power cord from the AC outlet.
- Do not shut down the computer or initiate Sleep.
- Do not insert, remove, connect, or disconnect any device, cable, or cord.

 **NOTE:** If your computer is connected to a network, consult the network administrator before installing any software updates, especially system BIOS updates.

1. Type `support` in the taskbar search box, and then select the **HP Support Assistant** app.
– or –
Select the question mark icon in the taskbar.
2. Select **Updates**, and then select **Check for updates and messages**.
3. Follow the on-screen instructions.
4. At the download area, follow these steps:
 - a. Identify the most recent BIOS update and compare it to the BIOS version currently installed on your computer. If the update is more recent than your BIOS version, make a note of the date, name, or other identifier. You might need this information to locate the update later, after it has been downloaded to your hard drive.
 - b. Follow the on-screen instructions to download your selection to the hard drive.

Make a note of the path to the location on your hard drive where the BIOS update is downloaded. You will need to access this path when you are ready to install the update.

BIOS installation procedures vary. Follow any instructions that appear on the screen after the download is complete. If no instructions appear, follow these steps:

1. Type `file` in the taskbar search box, and then select **File Explorer**.
2. Select your hard drive designation. The hard drive designation is typically Local Disk (C:).
3. Using the hard drive path you recorded earlier, open the folder that contains the update.
4. Double-click the file that has an `.exe` extension (for example, `filename.exe`).

The BIOS installation begins.
5. Complete the installation by following the on-screen instructions.

 **NOTE:** After a message on the screen reports a successful installation, you can delete the downloaded file from your hard drive.

7 Using HP PC Hardware Diagnostics

Using HP PC Hardware Diagnostics Windows (select products only)

HP PC Hardware Diagnostics Windows is a Windows-based utility that allows you to run diagnostic tests to determine whether the computer hardware is functioning properly. The tool runs within the Windows operating system to diagnose hardware failures.

If HP PC Hardware Diagnostics Windows is not installed on your computer, first you must download and install it. To download HP PC Hardware Diagnostics Windows, see [Downloading HP PC Hardware Diagnostics Windows on page 56](#).

After HP PC Hardware Diagnostics Windows is installed, follow these steps to access it from HP Help and Support or HP Support Assistant.

1. To access HP PC Hardware Diagnostics Windows from HP Help and Support:

- a. Select the **Start** button, and then select **HP Help and Support**.
- b. Select **HP PC Hardware Diagnostics Windows**.

– or –

To access HP PC Hardware Diagnostics Windows from HP Support Assistant:

- a. Type `support` in the taskbar search box, and then select the **HP Support Assistant** app.

– or –

Select the question mark icon in the taskbar.

- b. Select **Troubleshooting and fixes**.
- c. Select **Diagnostics**, and then select **HP PC Hardware Diagnostics Windows**.

2. When the tool opens, select the type of diagnostic test that you want to run, and then follow the on-screen instructions.

 **NOTE:** To stop a diagnostic test, select **Cancel**.

When HP PC Hardware Diagnostics Windows detects a failure that requires hardware replacement, a 24-digit Failure ID code is generated. The screen displays one of the following options:

- A Failure ID link is displayed. Select the link and follow the on-screen instructions.
- Instructions for calling support are displayed. Follow those instructions.

Downloading HP PC Hardware Diagnostics Windows

- The HP PC Hardware Diagnostics Windows downloading instructions are provided in English only.
- You must use a Windows computer to download this tool because only .exe files are provided.

Downloading the latest HP PC Hardware Diagnostics Windows version

To download HP PC Hardware Diagnostics Windows, follow these steps:

1. Go to <http://www.hp.com/go/techcenter/pcdiags>. The HP PC Diagnostics home page is displayed.
2. Select **Download HP Diagnostics Windows**, and then select a location on your computer or a USB flash drive.

The tool downloads to the selected location.

– or –

You can use the following steps to download the HP PC Hardware Diagnostics Windows from the Microsoft Store:

1. Select the Microsoft app on your desktop or enter `Microsoft Store` in the taskbar search box.
2. Enter `HP PC Hardware Diagnostics Windows` in the **Microsoft Store** search box.
3. Follow the on-screen directions.

The tool downloads to the selected location.

Downloading HP Hardware Diagnostics Windows by product name or number (select products only)



NOTE: For some products, you might have to download the software to a USB flash drive by using the product name or number.

To download HP PC Hardware Diagnostics Windows by product name or number, follow these steps:

1. Go to <http://www.hp.com/support>.
2. Select **Get software and drivers**, select your type of product, and then enter the product name or number in the search box that is displayed.
3. In the **Diagnostics** section, select **Download**, and then follow the on-screen instructions to select the specific Windows diagnostics version to be downloaded to your computer or USB flash drive.

The tool downloads to the selected location.

Installing HP PC Hardware Diagnostics Windows

To install HP PC Hardware Diagnostics Windows, follow these steps:

- ▲ Navigate to the folder on your computer or the USB flash drive where the .exe file downloaded, double-click the .exe file, and then follow the on-screen instructions.

Using HP PC Hardware Diagnostics UEFI



NOTE: For Windows 10 S computers, you must use a Windows computer and a USB flash drive to download and create the HP UEFI support environment because only .exe files are provided. For more information, see [Downloading HP PC Hardware Diagnostics UEFI to a USB flash drive on page 58](#).

HP PC Hardware Diagnostics UEFI (Unified Extensible Firmware Interface) allows you to run diagnostic tests to determine whether the computer hardware is functioning properly. The tool runs outside the operating system so that it can isolate hardware failures from issues that are caused by the operating system or other software components.

If your PC does not start in Windows, you can use HP PC Hardware Diagnostics UEFI to diagnose hardware issues.

When HP PC Hardware Diagnostics UEFI detects a failure that requires hardware replacement, a 24-digit Failure ID code is generated. For assistance in solving the problem:

- ▲ Select **Contact HP**, accept the HP privacy disclaimer, and then use a mobile device to scan the Failure ID code that appears on the next screen. The HP Customer Support - Service Center page appears with your Failure ID and product number automatically filled in. Follow the on-screen instructions.

– or –

Contact support, and provide the Failure ID code.

 **NOTE:** To start diagnostics on a convertible computer, your computer must be in notebook mode, and you must use the attached keyboard.

 **NOTE:** If you need to stop a diagnostic test, press *esc*.

Starting HP PC Hardware Diagnostics UEFI

To start HP PC Hardware Diagnostics UEFI, follow these steps:

1. Turn on or restart the computer, and quickly press *esc*.
2. Press *f2*.

The BIOS searches three places for the diagnostic tools, in the following order:

- a. Connected USB flash drive

 **NOTE:** To download the HP PC Hardware Diagnostics UEFI tool to a USB flash drive, see [Downloading the latest HP PC Hardware Diagnostics UEFI version on page 58](#).

- b. Hard drive

- c. BIOS

3. When the diagnostic tool opens, select a language, select the type of diagnostic test you want to run, and then follow the on-screen instructions.

Downloading HP PC Hardware Diagnostics UEFI to a USB flash drive

Downloading HP PC Hardware Diagnostics UEFI to a USB flash drive can be useful in the following situations:

- HP PC Hardware Diagnostics UEFI is not included in the preinstallation image.
- HP PC Hardware Diagnostics UEFI is not included in the HP Tool partition.
- The hard drive is damaged.

 **NOTE:** The HP PC Hardware Diagnostics UEFI downloading instructions are provided in English only, and you must use a Windows computer to download and create the HP UEFI support environment because only .exe files are provided.

Downloading the latest HP PC Hardware Diagnostics UEFI version

To download the latest HP PC Hardware Diagnostics UEFI version to a USB flash drive:

1. Go to <http://www.hp.com/go/techcenter/pcdiags>. The HP PC Diagnostics home page is displayed.
2. Select **Download HP Diagnostics UEFI**, and then select **Run**.

Downloading HP PC Hardware Diagnostics UEFI by product name or number (select products only)

 **NOTE:** For some products, you might have to download the software to a USB flash drive by using the product name or number.

To download HP PC Hardware Diagnostics UEFI by product name or number (select products only) to a USB flash drive:

1. Go to <http://www.hp.com/support>.
2. Enter the product name or number, select your computer, and then select your operating system.
3. In the **Diagnostics** section, follow the on-screen instructions to select and download the specific UEFI Diagnostics version for your computer.

Using Remote HP PC Hardware Diagnostics UEFI settings (select products only)

Remote HP PC Hardware Diagnostics UEFI is a firmware (BIOS) feature that downloads HP PC Hardware Diagnostics UEFI to your computer. It can then execute the diagnostics on your computer, and it might upload results to a preconfigured server. For more information about Remote HP PC Hardware Diagnostics UEFI, go to <http://www.hp.com/go/techcenter/pcdiags>, and then select **Find out more**.

Downloading Remote HP PC Hardware Diagnostics UEFI

 **NOTE:** HP Remote PC Hardware Diagnostics UEFI is also available as a SoftPaq that you can download to a server.

Downloading the latest Remote HP PC Hardware Diagnostics UEFI version

To download the latest Remote HP PC Hardware Diagnostics UEFI version, follow these steps:

1. Go to <http://www.hp.com/go/techcenter/pcdiags>. The HP PC Diagnostics home page is displayed.
2. Select **Download Remote Diagnostics**, and then select **Run**.

Downloading Remote HP PC Hardware Diagnostics UEFI by product name or number

 **NOTE:** For some products, you might have to download the software by using the product name or number.

To download HP Remote PC Hardware Diagnostics UEFI by product name or number, follow these steps:

1. Go to <http://www.hp.com/support>.
2. Select **Get software and drivers**, select your type of product, enter the product name or number in the search box that is displayed, select your computer, and then select your operating system.
3. In the **Diagnostics** section, follow the on-screen instructions to select and download the **Remote UEFI** version for the product.

Customizing Remote HP PC Hardware Diagnostics UEFI settings

Using the Remote HP PC Hardware Diagnostics setting in Computer Setup (BIOS), you can perform the following customizations:

- Set a schedule for running diagnostics unattended. You can also start diagnostics immediately in interactive mode by selecting **Execute Remote HP PC Hardware Diagnostics**.
- Set the location for downloading the diagnostic tools. This feature provides access to the tools from the HP website or from a server that has been preconfigured for use. Your computer does not require the traditional local storage (such as a hard drive or USB flash drive) to run remote diagnostics.
- Set a location for storing the test results. You can also set the user name and password that you use for uploads.
- Display status information about the diagnostics run previously.

To customize Remote HP PC Hardware Diagnostics UEFI settings, follow these steps:

1. Turn on or restart the computer, and when the HP logo appears, press **f10** to enter Computer Setup.
2. Select **Advanced**, and then select **Settings**.
3. Make your customization selections.
4. Select **Main**, and then **Save Changes and Exit** to save your settings.

Your changes take effect when the computer restarts.

8 Backing up, restoring, and recovering

This chapter provides information about the following processes, which are standard procedure for most products:

- **Backing up your personal information**—You can use Windows tools to back up your personal information (see [Using Windows tools on page 61](#)).
- **Creating a restore point**—You can use Windows tools to create a restore point (see [Using Windows tools on page 61](#)).
- **Creating recovery media** (select products only)—You can use the HP Cloud Recovery Download Tool (select products only) to create recovery media (see [Using the HP Cloud Recovery Download Tool to create recovery media \(select products only\) on page 61](#)).
- **Restoring and recovery**—Windows offers several options for restoring from backup, refreshing the computer, and resetting the computer to its original state (see [Using Windows tools on page 61](#)).

 **IMPORTANT:** If you will be performing recovery procedures on a tablet, the tablet battery must be at least 70% charged before you start the recovery process.

IMPORTANT: For a tablet with a detachable keyboard, connect the tablet to the keyboard base before beginning any recovery process.

Backing up information and creating recovery media

Using Windows tools

 **IMPORTANT:** Windows is the only option that allows you to back up your personal information. Schedule regular backups to avoid information loss.

You can use Windows tools to back up personal information and create system restore points and recovery media.

 **NOTE:** If computer storage is 32 GB or less, Microsoft System Restore is disabled by default.

For more information and steps, see the Get Help app.

1. Select the **Start** button, and then select the **Get Help** app.
2. Enter the task you want to perform.

 **NOTE:** You must be connected to the Internet to access the Get Help app.

Using the HP Cloud Recovery Download Tool to create recovery media (select products only)

You can use the HP Cloud Recovery Download Tool to create HP Recovery media on a bootable USB flash drive.

For details:

- ▲ Go to <http://www.hp.com/support>, search for HP Cloud Recovery, and then select the result that matches the type of computer that you have.



NOTE: If you cannot create recovery media yourself, contact support to obtain recovery discs. Go to <http://www.hp.com/support>, select your country or region, and then follow the on-screen instructions.

Restoring and recovery

Restoring, resetting, and refreshing using Windows tools

Windows offers several options for restoring, resetting, and refreshing the computer. For details, see [Using Windows tools on page 61](#).

Recovering using HP Recovery media

You can use HP Recovery media to recover the original operating system and software programs that were installed at the factory. On select products, it can be created on a bootable USB flash drive using the HP Cloud Recovery Download Tool. For details, see [Using the HP Cloud Recovery Download Tool to create recovery media \(select products only\) on page 61](#).



NOTE: If you cannot create recovery media yourself, contact support to obtain recovery discs. Go to <http://www.hp.com/support>, select your country or region, and then follow the on-screen instructions.

To recover your system:

- ▲ Insert the HP Recovery media, and then restart the computer.

Changing the computer boot order

If your computer does not restart using the HP Recovery media, you can change the computer boot order. This is the order of devices listed in BIOS where the computer looks for startup information. You can change the selection to an optical drive or a USB flash drive, depending on the location of your HP Recovery media.

To change the boot order:



IMPORTANT: For a tablet with a detachable keyboard, connect the tablet to the keyboard base before beginning these steps.

1. Insert the HP Recovery media.
2. Access the system **Startup** menu.

For computers or tablets with keyboards attached:

- ▲ Turn on or restart the computer or tablet, quickly press **esc**, and then press **f9** for boot options.

For tablets without keyboards:

- ▲ Turn on or restart the tablet, quickly hold down the volume up button, and then select **f9**.

– or –

Turn on or restart the tablet, quickly hold down the volume down button, and then select **f9**.

3. Select the optical drive or USB flash drive from which you want to boot, and then follow the on-screen instructions.

Using HP Sure Recover (select products only)

Select computer models are configured with HP Sure Recover, a PC OS recovery solution built into the hardware and firmware. HP Sure Recover can fully restore the HP OS image without installed recovery software.

Using HP Sure Recover, an administrator or user can restore the system and install:

- Latest version of the operating system
- Platform-specific device drivers
- Software applications, in the case of a custom image

To access the latest documentation for HP Sure Recover, go to <http://www.hp.com/support>. Select **Find your product**, and then follow the on-screen instructions.

9 Specifications

Computer specifications

Table 9-1 Computer specifications

	Metric	U.S.
Computer dimensions		
Width	324.0 mm	12.8 in
Depth	225.0 mm	8.9 in
Height	19.9 mm	0.8 in
Weight (lowest configuration)	1520.0 g	3.35 lbs
Input power		
Operating voltage and current	18.5 V dc @ 3.5 A – 65 W	
Temperature		
Operating	5°C to 35°C	41°F to 95°F
Nonoperating	-20°C to 60°C	-4°F to 140°F
Relative humidity (noncondensing)		
Operating	10% to 90%	
Nonoperating	5% to 95%	
Maximum altitude (unpressurized)		
Operating	-15 m to 3,048 m	-50 ft to 10,000 ft
Nonoperating	-15 m to 12,192 m	-50 ft to 40,000 ft
NOTE: Applicable product safety standards specify thermal limits for plastic surfaces. The device operates well within this range of temperatures.		

35.6 cm (14.0 in) display specifications

Table 9-2 Display specifications

	Metric	U.S.
Active diagonal size	35.6 cm	14.0 in
Resolution	1920 × 1080	
Surface treatment	BrightView	
Brightness	250 nits	
Viewing angle	UWVA	
Backlight	LED	
Aspect ratio	16:9	
Display panel interface	eDP	

M.2 PCIe solid-state drive specifications

Table 9-3 M.2 PCIe solid-state drive specifications

	256 GB*
Dimensions	
Height	1 mm
Length	50.8 mm
Width	28.9 mm
Weight	< 10 g
Interface type	ATA-7
Transfer rate	
Sequential Read	Up to 2150 MB/s
Random Read	Up to 300,000 IOPs
Sequential Write	Up to 1260 MB/s
Random Write	Up to 100,000 IOPs
Ready time, Maximum (to not busy)	1.0 sec
Access times	
Logical	0.1
Total logical sectors	500,118,192
Operating temperature	
Operating	0° to 70°C (32°F to 158°F)
Non-operating	-40° to 80°C (-40°F to 176°F)
*1 GB = 1 billion bytes when referring to hard drive storage capacity. Actual accessible capacity is less.	
NOTE: Certain restrictions and exclusions apply. Contact technical support for details.	

Hard drive specifications

Table 9-4 Hard drive specifications

	1 TB*
Dimensions	
Height	7.2 mm
Length	100.4 mm
Width	69.9 mm
Weight	115.0 g
Interface type	SATA
Transfer rate	
Synchronous (maximum)	300 MB/s
Security	ATA security
Seek times (typical read, including setting)	
Single track	1.4 ms
Average (read/write)	10 ms
Maximum	12 ms
Logical blocks	1,938,921,461
Disk rotational speed	5400 rpm
Operating temperature	0°C to 60°C (32°F to 140°F)
*1 GB = 1 billion bytes when referring to hard drive storage capacity. Actual accessible capacity is less.	
NOTE: Certain restrictions and exclusions apply. Contact technical support for details.	

10 Power cord set requirements

The wide-range input feature of the computer permits it to operate from any line voltage from 100 V ac to 120 V ac, or from 220 V ac to 240 V ac.

The three-conductor power cord set included with the computer meets the requirements for use in the country or region where the equipment is purchased.

Power cord sets for use in other countries or regions must meet the requirements of the country and region where the computer is used.

Requirements for all countries

The following requirements are applicable to all countries and regions:

- The length of the power cord set must be at least **1.0 m** (3.3 ft) and no more than **2.0 m** (6.5 ft).
- All power cord sets must be approved by an acceptable accredited agency responsible for evaluation in the country or region where the power cord set will be used.
- The power cord sets must have a minimum current capacity of 10 A and a nominal voltage rating of 125 V ac or 250 V ac, as required by the power system of each country or region.
- The appliance coupler must meet the mechanical configuration of an EN 60 320/IEC 320 Standard Sheet C13 connector for mating with the appliance inlet on the back of the computer.

Requirements for specific countries and regions

Table 10-1 Power cord requirements for specific countries and regions

Country/region	Accredited agency	Applicable note number
Argentina	IRAM	1
Australia	SAA	1
Austria	OVE	1
Belgium	CEBEC	1
Brazil	ABNT	1
Canada	CSA	2
Chile	IMQ	1
Denmark	DEMKO	1
Finland	FIMKO	1
France	UTE	1
Germany	VDE	1
India	BIS	1
Israel	SII	1
Italy	IMQ	1
Japan	JIS	3
The Netherlands	KEMA	1
New Zealand	SANZ	1
Norway	NEMKO	1
The People's Republic of China	CCC	4
Saudi Arabia	SASO	7
Singapore	PSB	1
South Africa	SABS	1
South Korea	KTL	5
Sweden	SEMKO	1
Switzerland	SEV	1
Taiwan	BSMI	6
Thailand	TISI	1
The United Kingdom	ASTA	1
The United States	UL	2

1. The flexible cord must be Type H05VV-F, 3-conductor, 0.75 mm² conductor size. Power cord set fittings (appliance coupler and wall plug) must bear the certification mark of the agency responsible for evaluation in the country or region where it will be used.

Table 10-1 Power cord requirements for specific countries and regions (continued)

Country/region	Accredited agency	Applicable note number
		2. The flexible cord must be Type SVT/SJT or equivalent, No. 18 AWG, 3 conductor. The wall plug must be a two-pole grounding type with a NEMA 5-15P (15 A, 125 V ac) or NEMA 6-15P (15 A, 250 V ac) configuration. CSA or C-UL mark. UL file number must be on each element.
		3. The appliance coupler, flexible cord, and wall plug must bear a “T” mark and registration number in accordance with the Japanese Dentori Law. The flexible cord must be Type VCTF, 3-conductor, 0.75 mm ² or 1.25 mm ² conductor size. The wall plug must be a two-pole grounding type with a Japanese Industrial Standard C8303 (7 A, 125 V ac) configuration.
		4. The flexible cord must be Type RVV, 3-conductor, 0.75 mm ² conductor size. Power cord set fittings (appliance coupler and wall plug) must bear the CCC certification mark.
		5. The flexible cord must be Type H05VV-F 3-conductor, 0.75 mm ² conductor size. KTL logo and individual approval number must be on each element. Approval number and logo must be printed on a flag label.
		6. The flexible cord must be Type HVCTF 3-conductor, 1.25 mm ² conductor size. Power cord set fittings (appliance coupler, cable, and wall plug) must bear the BSMI certification mark.
		7. For 127 V ac, the flexible cord must be Type SVT or SJT 3-conductor, 18 AWG, with plug NEMA 5-15P (15 A, 125 V ac), with UL and CSA or C-UL marks. For 240 V ac, the flexible cord must be Type H05VV-F 3-conductor, 0.75 mm ² or 1.00 mm ² conductor size, with plug BS 1363/A with BSI or ASTA marks.

11 Recycling

When a non-rechargeable or rechargeable battery has reached the end of its useful life, do not dispose of the battery in general household waste. Follow the local laws and regulations in your area for battery disposal.

HP encourages customers to recycle used electronic hardware, HP original print cartridges, and rechargeable batteries. For more information about recycling programs, see the HP website at <http://www.hp.com/recycle>.

Index

- A**
 - AC adapter and battery light, identifying 4
 - action keys
 - identifying 10
 - antenna
 - removal 51, 52
 - antennas
 - spare part number 52
 - audio, product description 1
 - audio-out (headphone)/audio-in (microphone) combo jack, identifying 4
- B**
 - back cover
 - spare part number 16
 - backup, creating 61
 - backups 61
 - battery
 - removal 25
 - spare part number 14, 25
 - bezel
 - spare part number 15, 48
 - BIOS
 - determining version 54
 - downloading an update 55
 - starting the Setup Utility 54
 - updating 54
 - Bluetooth label 12
 - boot order, changing 62
 - bottom components 11
 - bottom cover
 - removal 23
 - spare part number 15, 23
 - buttons
 - left touchpad 7
 - power 9
 - right touchpad 7
- C**
 - camera
 - identifying 6
 - camera light, identifying 6
 - caps lock light, identifying 8
 - cautions
 - electrostatic discharge 18
 - component
 - isplay 6
 - components
 - bottom 11
 - keyboard area 7
 - left side 5
 - right side 4
 - computer major components 13
 - computer specifications 64
 - connectors
 - power 5
- D**
 - display assembly
 - removal 46
 - display back cover
 - spare part number 52
 - display cable
 - removal 51
 - display components 6
 - display panel
 - product description 1
 - removal 49
 - spare part numbers 15
 - display panel cable
 - spare part numbers 15, 51
 - display specifications 65
 - drive light, identifying 5
- E**
 - electrostatic discharge (ESD) 18
 - preventing damage 19
 - esc key, identifying 10
- F**
 - fan
 - removal 41
 - spare part number 14, 41
 - fn key, identifying 10
- G**
 - graphics, product description 1
 - grounding methods 20
- H**
 - guidelines
 - packaging 21
 - transporting 21
 - workstation 18
 - hard drive
 - removing 29
 - specifications 67
 - hard drive cable
 - illustrated 29
 - hard drive connector
 - removing 30
 - hard drive cover
 - illustrated 29
 - removing 29
 - HDMI port
 - identifying 4
 - heat sink
 - spare part number 14
 - heat sink assembly
 - removal 42
 - spare part number 42
 - hinge
 - removal 51
 - spare part number 51
 - hinge cover
 - spare part number 15
 - hinges
 - spare part number 15
 - HP PC Hardware Diagnostics UEFI
 - downloading 58
 - starting 58
 - using 57
 - HP PC Hardware Diagnostics Windows
 - downloading 56
 - installing 57
 - using 56
 - HP Recovery media
 - recovery 62
 - HP Sure Recover 63
- I**
 - internal card expansion, product description 2

internal microphone, identifying 6

J

jacks

audio-out (headphone)/audio-in (microphone) 4

K

keyboard/pointing devices, product description 2

keyboard/top cover

spare part numbers 14

keys

action 10
esc 10
fn 10
Windows 10

L

labels

Bluetooth 12
regulatory 12
serial number 12
service 12
wireless certification 12
WLAN 12

left side components 5

lights

AC adapter and battery 4
camera 6
caps lock 8
drive 5
mute 8
power 5

M

M.2 solid-state drive

specifications 66

media card reader, product description 2

memory module

removal 26
spare part numbers 26

memory, product description 1

microphone

product description 1

model name 1

mute light, identifying 8

O

operating system, product description 3

P

packaging guidelines 21

ports

HDMI 4
product description 2
USB SuperSpeed 4
USB Type-C 5

power button, identifying 9

power connector

identifying 5

power connector cable

removal 37
spare part number 14, 37

power cord

requirements for all countries 68
requirements for specific countries and regions 69
set requirements 68
spare part numbers 16

power lights, identifying 5

power requirements, product description 2

processor, product description 1

product description

audio 1
display panel 1
graphics 1
internal card expansion 2
keyboard/pointing devices 2
media card reader 2
memory 1
microphone 1
operating system 3
ports 2
power requirements 2
processors 1
product name 1
security 2
serviceability 3
storage 1
video 1
wireless networking 1

product name 1

product name and number, computer 12

R

recovery 61

discs 62
HP Recovery partition 62
media 62
USB flash drive 62

recovery media

creating using HP Cloud Recovery Download Tool 61
creating using Windows tools 61

regulatory information

regulatory label 12
wireless certification labels 12

Remote HP PC Hardware Diagnostics

UEFI settings
customizing 59
using 59

removal/replacement procedures 22

restoring 61

right side components 4

rubber feet

spare part number 15, 23

S

Screw Kit, spare part number 16

security cable slot, identifying 5

security, product description 2

serial number, computer 12

service labels, locating 12

serviceability, product description 3

SIM slot, identifying 4

slots

memory card reader 5
security cable 5
SIM card 4

solid-state drive

removal 28
spare part number 14
spare part numbers 28

speaker assembly

removal 36
spare part number 36

speakers

identifying 9
spare part number 14

special keys, using 10

specifications

computer 64
display 65

- hard drive 67
- M.2 solid-state drive 66
- static electricity 19
- storage, product description 1
- system board
 - removal 44
 - spare part numbers 44
- system restore point, creating 61

T

- top cover/keyboard
 - removal 53
 - spare part numbers 53
- touchpad
 - removal 40
 - settings 7
 - spare part numbers 14, 40
- touchpad buttons
 - identifying 7
- touchpad click board
 - removal 39
 - spare part numbers 39
- touchpad zone, identifying 7
- transporting guidelines 21
- traveling with the computer 12

U

- USB SuperSpeed port, identifying 4
- USB Type-C port, identifying 5
- USB, card reader, and power button board
 - removal 35
 - spare part number 35
- USB/card reader/power button board
 - spare part number 14

V

- vents, identifying 9, 11
- video, product description 1

W

- webcam
 - spare part number 49
- webcam module
 - removal 48
- webcam/microphone module
 - spare part number 16
- Windows
 - backup 61
 - recovery media 61
 - system restore point 61

- Windows key, identifying 10
- Windows tools, using 61
- wireless antennas
 - spare part number 52
- wireless antennas, identifying 6
- wireless certification label 12
- wireless networking, product description 1
- WLAN antennas, identifying 6
- WLAN device 12
- WLAN label 12
- WLAN module
 - removal 31, 33
 - spare part numbers 14, 31, 33
- workstation guidelines 18
- WWAN antennas, identifying 6
- WWAN module
 - spare part number 14