

Owner's Manual & Safety Instructions

Save This Manual Keep this manual for the safety warnings and precautions, assembly, operating, inspection, maintenance and cleaning procedures. Write the product's serial number in the back of the manual near the assembly diagram (or month and year of purchase if product has no number). Keep this manual and the receipt in a safe and dry place for future reference.

21d

CENTRALPNEUMATIC®

1/4" air hydraulic riveter



Visit our website at: <http://www.harborfreight.com>
Email our technical support at: productsupport@harborfreight.com

62685

When unpacking, make sure that the product is intact and undamaged. If any parts are missing or broken, please call 1-888-866-5797 as soon as possible.

Copyright© 2021 by Harbor Freight Tools®. All rights reserved.
No portion of this manual or any artwork contained herein may be reproduced in any shape or form without the express written consent of Harbor Freight Tools. Diagrams within this manual may not be drawn proportionally. Due to continuing improvements, actual product may differ slightly from the product described herein. Tools required for assembly and service may not be included.

⚠WARNING





Read this material before using this product. Failure to do so can result in serious injury. **SAVE THIS MANUAL.**

Table of Contents

Safety	2	Maintenance	12
Specifications	6	Parts List and Diagram	14
Setup	7	Warranty	16
Operation.....	10		

CENTRALPNEUMATIC®

WARNING SYMBOLS AND DEFINITIONS

	This is the safety alert symbol. It is used to alert you to potential personal injury hazards. Obey all safety messages that follow this symbol to avoid possible injury or death.
	Indicates a hazardous situation which, if not avoided, will result in death or serious injury.
	Indicates a hazardous situation which, if not avoided, could result in death or serious injury.
	Indicates a hazardous situation which, if not avoided, could result in minor or moderate injury.
	Addresses practices not related to personal injury.

IMPORTANT SAFETY INSTRUCTIONS

INSTRUCTIONS PERTAINING TO A RISK OF FIRE, ELECTRIC SHOCK, OR INJURY TO PERSONS

WARNING – When using tools, basic precautions should always be followed, including the following:



General

To reduce the risks of electric shock, fire, and injury to persons, read all the instructions before using the tool.

Work Area

- Keep the work area clean and well lighted.**
Cluttered benches and dark areas increase the risks of electric shock, fire, and injury to persons.
- Do not operate the tool in explosive atmospheres, such as in the presence of flammable liquids, gases, or dust.**
The tool is able to create sparks resulting in the ignition of the dust or fumes.
- Keep bystanders, children, and visitors away while operating the tool.** Distractions are able to result in the loss of control of the tool.

Personal Safety

- 1. Stay alert. Watch what you are doing and use common sense when operating the tool. Do not use the tool while tired or under the influence of drugs, alcohol, or medication.**
A moment of inattention while operating the tool increases the risk of injury to persons.
- 2. Dress properly. Do not wear loose clothing or jewelry. Contain long hair. Keep hair, clothing, and gloves away from moving parts.** Loose clothes, jewelry, or long hair increases the risk of injury to persons as a result of being caught in moving parts.
- 3. Avoid unintentional starting. Be sure the switch is off before connecting to the air supply.**
Do not carry the tool with your finger on the switch or connect the tool to the air supply with the switch on.
- 4. Do not overreach. Keep proper footing and balance at all times.**
Proper footing and balance enables better control of the tool in unexpected situations.
- **5. Use safety equipment.**
A dust mask, non-skid safety shoes and a hard hat must be used for the applicable conditions.
- **6. Always wear eye protection.**
Wear ANSI-approved safety goggles.
- **7. Always wear hearing protection when using the tool.**
Prolonged exposure to high intensity noise is able to cause hearing loss.

Tool Use and Care

- 1. Use clamps or another practical way to secure and support the workpiece to a stable platform.**
Holding the work by hand or against the body is unstable and is able to lead to loss of control.
- 2. Do not force the tool.** Use the correct tool for the application. The correct tool will do the job better and safer at the rate for which the tool is designed.
- 3. Do not use the tool if the switch does not turn the tool on or off.** Any tool that cannot be controlled with the switch is dangerous and must be repaired.
- 4. Disconnect the tool from the air source before making any adjustments, changing accessories, or storing the tool.** Such preventive safety measures reduce the risk of starting the tool unintentionally. Turn off and detach the air supply, safely discharge any residual air pressure, and release the throttle and/or turn the switch to its off position before leaving the work area.
- 5. Store the tool when it is idle out of reach of children and other untrained persons.**
A tool is dangerous in the hands of untrained users.
- 6. Maintain the tool with care.** Keep a cutting tool sharp and clean. A properly maintained tool, with sharp cutting edges reduces the risk of binding and is easier to control.
- 7. Check for misalignment or binding of moving parts, breakage of parts, and any other condition that affects the tool's operation.** If damaged, have the tool serviced before using. Many accidents are caused by poorly maintained tools. There is a risk of bursting if the tool is damaged.
- 8. Use only accessories that are identified by the manufacturer for the specific tool model.** Use of an accessory not intended for use with the specific tool model, increases the risk of injury to persons.

Service

- 1. Tool service must be performed only by qualified repair personnel.**
- 2. When servicing a tool, use only identical replacement parts. Use only authorized parts.**
- 3. Use only the lubricants supplied with the tool or specified by the manufacturer.**

Air Source

- 

Never connect to an air source that is capable of exceeding 200 psi. Over pressurizing the tool may cause bursting, abnormal operation, breakage of the tool or serious injury to persons. Use only clean, dry, regulated compressed air at the rated pressure or within the rated pressure range as marked on the tool. Always verify prior to using the tool that the air source has been adjusted to the rated air pressure or within the rated air-pressure range.
- Never use oxygen, carbon dioxide, combustible gases or any bottled gas as an air source for the tool.** Such gases are capable of explosion and serious injury to persons.



SAVE THESE INSTRUCTIONS.

Symbols and Specific Safety Instructions

Specific Safety Instructions

- Attach the Pin Cap to the Riveter before use. Turn the slot in the Pin Cap upward to avoid spilling used Rivet Pins.
- The warnings and precautions discussed in this manual cannot cover all possible conditions and situations that may occur. It must be understood by the operator that common sense and caution are factors which cannot be built into this product, but must be supplied by the operator.
- Obey the manual for the air compressor used to power this tool.
- Install an in-line shutoff valve to allow immediate control over the air supply in an emergency, even if a hose is ruptured.
- Do not lay the tool down until it has come to a complete stop. Moving parts can grab the surface and pull the tool out of your control.

Vibration Precautions

This tool vibrates during use. Repeated or long-term exposure to vibration may cause temporary or permanent physical injury, particularly to the hands, arms and shoulders. To reduce the risk of vibration-related injury:





- Anyone using vibrating tools regularly or for an extended period should first be examined by a doctor and then have regular medical check-ups to ensure medical problems are not being caused or worsened from use. Pregnant women or people who have impaired blood circulation to the hand, past hand injuries, nervous system disorders, diabetes, or Raynaud's Disease should not use this tool. If you feel any symptoms related to vibration (such as tingling, numbness, and white or blue fingers), seek medical advice as soon as possible.
- Do not smoke during use. Nicotine reduces the blood supply to the hands and fingers, increasing the risk of vibration-related injury.
- Wear suitable gloves to reduce the vibration effects on the user.
- Use tools with the lowest vibration when there is a choice.
- Include vibration-free periods each day of work.
- Grip tool as lightly as possible (while still keeping safe control of it). Let the tool do the work.
- To reduce vibration, maintain tool as explained in this manual. If abnormal vibration occurs, stop immediately.



SAVE THESE INSTRUCTIONS.

Symbology

Symbol	Property or statement
PSI	Pounds per square inch of pressure
BPM	Blows per minute
CFM	Cubic Feet per Minute flow
SCFM	Cubic Feet per Minute flow at standard conditions
NPT	National pipe thread, tapered
NPS	National pipe thread, straight

Symbol	Property or statement
	WARNING marking concerning Risk of Eye Injury. Wear ANSI-approved eye protection.
	WARNING marking concerning Risk of Hearing Loss. Wear hearing protection.
	WARNING marking concerning Risk of Respiratory Injury. Wear NIOSH-approved dust mask/respirator.
	WARNING marking concerning Risk of Explosion.

SAFETY

SETUP

OPERATION

MAINTENANCE

CENTRALPNEUMATIC®

Functional Description

Specifications

Maximum Air Pressure	120 PSI
Air Inlet	1/4"–18 NPT
Average Air Consumption	4.5 CFM @ 90 PSI
Rivet Pin Capacity	1/8", 5/32", 3/16", 1/4" (Nosepiece change needed)

Components and Controls

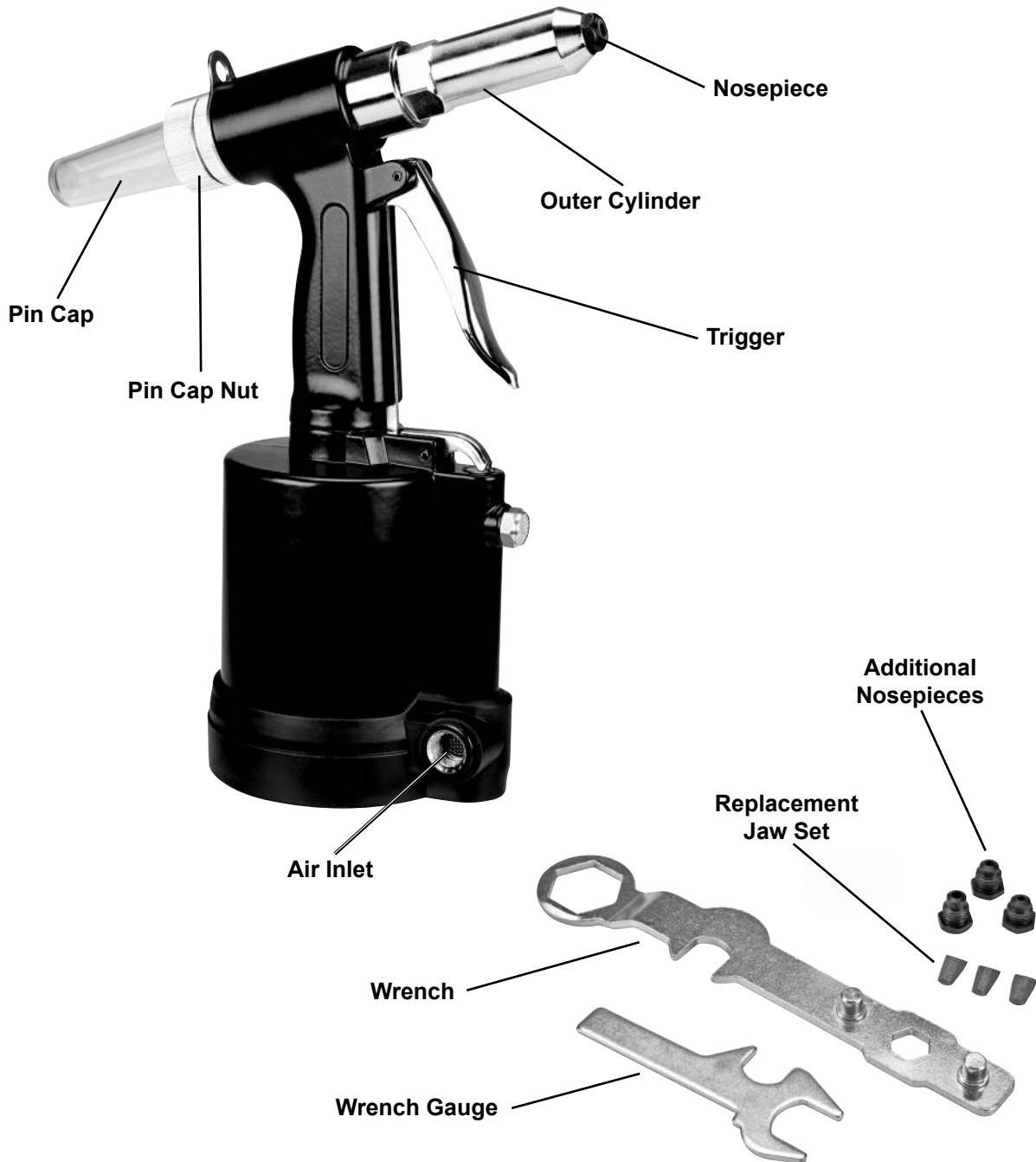

SAFETY

SETUP

OPERATION

MAINTENANCE

Initial Tool Set Up/Assembly



Read the **ENTIRE IMPORTANT SAFETY INFORMATION** section at the beginning of this manual including all text under subheadings therein before set up or use of this product.

Note: For additional information regarding the parts listed in the following pages, refer to the Assembly Diagram near the end of this manual.

Note: This air tool may be shipped with a protective plug covering the air inlet. Remove this plug before set up.

Air Supply

WARNING



TO PREVENT SERIOUS INJURY FROM EXPLOSION:

Use only clean, dry, regulated, compressed air to power this tool.
Do not use oxygen, carbon dioxide, combustible gases,
or any other bottled gas as a power source for this tool.

1. Incorporate a filter, regulator with pressure gauge, oiler, in-line shutoff valve, and quick coupler for best service, as shown on Figure A on page 8 and Figure B on page 9. **An in-line shutoff ball valve is an important safety device because it controls the air supply even if the air hose is ruptured. The shutoff valve should be a ball valve because it can be closed quickly.**
2. Attach an air hose to the compressor's air outlet. Connect the air hose to the air inlet of the tool. Other components, such as a coupler plug and quick coupler, will make operation more efficient, but are not required.
3. Turn the tool's throttle or switch to the off position; refer to Operation section for description of controls.
4. Close the in-line shutoff valve between the compressor and the tool.
5. Turn on the air compressor according to the manufacturer's directions and allow it to build up pressure until it cycles off.
6. Adjust the air compressor's output regulator so that the air output is enough to properly power the tool, but the output will not exceed the tool's maximum air pressure at any time. Adjust the pressure gradually, while checking the air output gauge to set the right pressure range.
7. Inspect the air connections for leaks. Repair any leaks found.
8. If the tool will not be used at this time, turn off and detach the air supply, safely discharge any residual air pressure, and release the throttle and/or turn the switch to its off position to prevent accidental operation.

Note: Air flow, and therefore tool performance, can be hindered by undersized air supply components. The air hose must be long enough to reach the work area with enough extra length to allow free movement while working.

WARNING! TO PREVENT SERIOUS INJURY FROM ACCIDENTAL OPERATION:
Do not install a female quick coupler on the tool. Such a coupler contains an air valve that will allow the air tool to retain pressure and operate accidentally after the air supply is disconnected.

Note: Residual air pressure should not be present after the tool is disconnected from the air supply. However, it is a good safety measure to attempt to discharge the tool in a safe fashion after disconnecting to ensure that the tool is disconnected and not powered.

Figure A: Portable Air Supply Setup

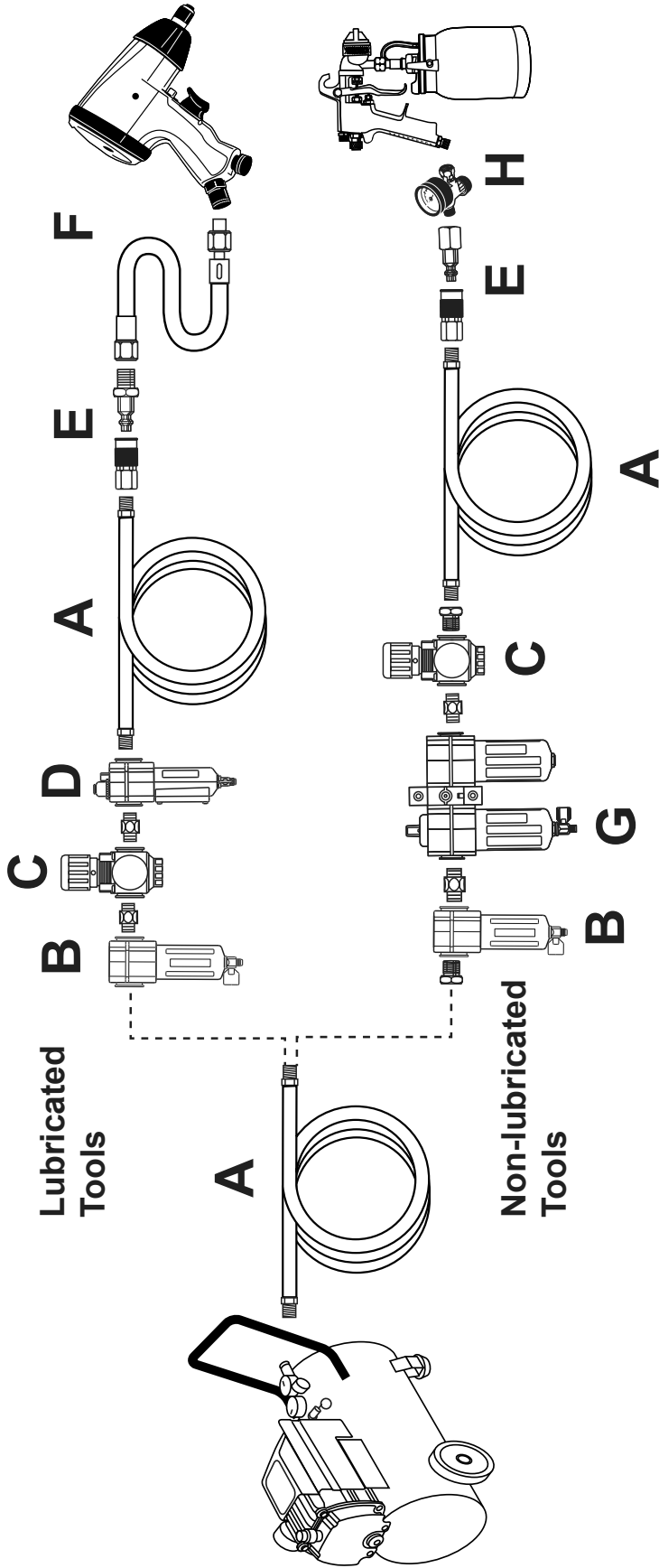

Description	Function
A Air Hose	Connects air to tool
B Filter	Prevents dirt and condensation from damaging tool or workpiece
C Regulator	Adjusts air pressure to tool
D Lubricator (optional)	For air tool lubrication
E Coupler and Plug	Provides quick connection and release
F Leader Hose (optional)	Increases coupler life
G Air Cleaner / Dryer (optional)	Prevents water vapor from damaging workpiece
H Air Adjusting Valve (optional)	For fine tuning airflow at tool

Figure B: Stationary Air Supply Setup

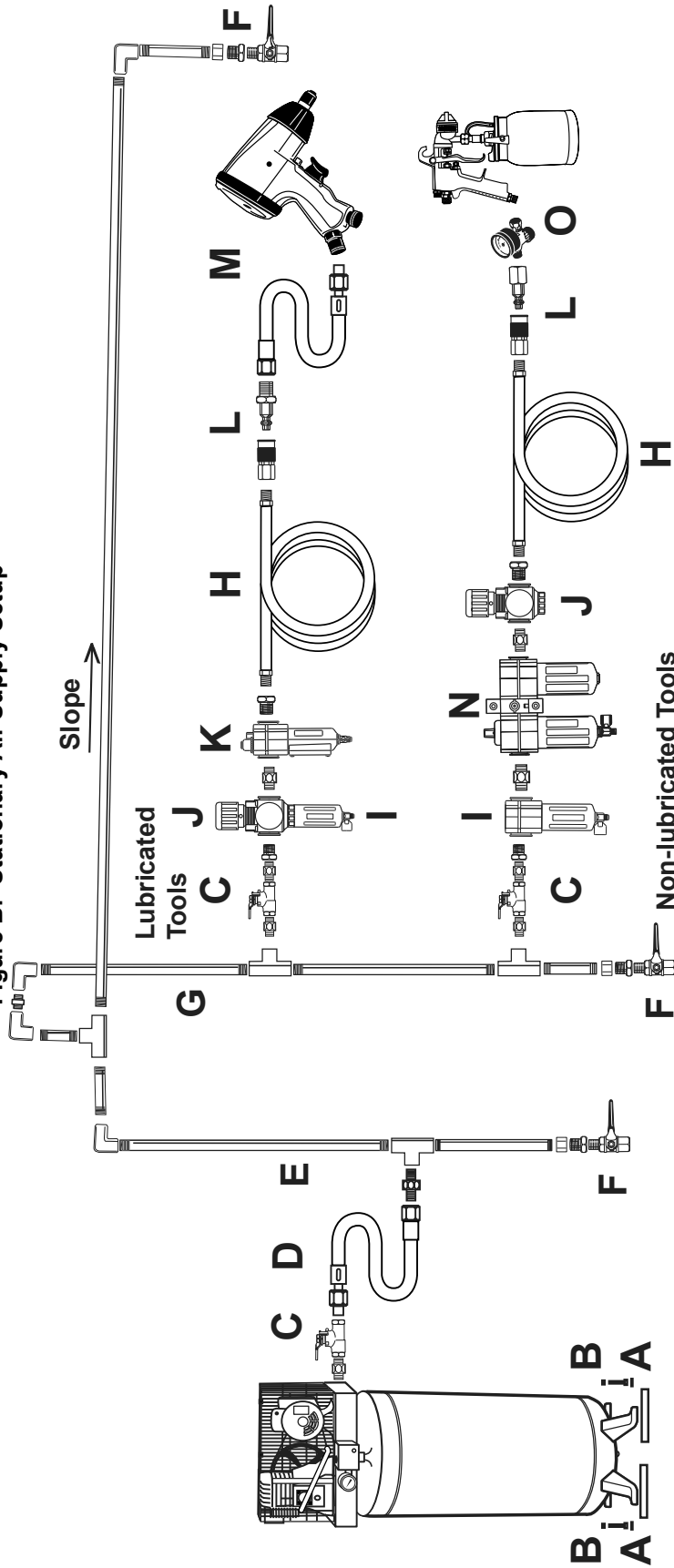

	Description	Function
A	Vibration Pads	For noise and vibration reduction
B	Anchor Bolts	Secures air compressor in place
C	Ball Valve	Isolates sections of system for maintenance
D	Isolation Hose	For vibration reduction
E	Main Air Line - 3/4" minimum recommended	Distributes air to branch lines
F	Ball Valve	To drain moisture from system
G	Branch Air Line - 1/2" minimum recommended	Brings air to point of use
H	Air Hose	Connects air to tool
I	Filter	Prevents dirt and condensation from damaging tool or workpiece
J	Regulator	Adjusts air pressure to tool
K	Lubricator (optional)	For air tool lubrication
L	Coupler and Plug	Provides quick connection and release
M	Leader Hose (optional)	Increases coupler life
N	Air Cleaner / Dryer (optional)	Prevents water vapor from damaging workpiece
O	Air Adjusting Valve (optional)	For fine tuning airflow at tool

Operating Instructions



Read the **ENTIRE IMPORTANT SAFETY INFORMATION** section at the beginning of this manual including all text under subheadings therein before set up or use of this product.

Inspect tool before use, looking for damaged, loose, and missing parts.
If any problems are found, do not use tool until repaired.

Tool Set Up

⚠️WARNING

TO PREVENT SERIOUS INJURY FROM ACCIDENTAL OPERATION:

Turn off the tool, detach the air supply, safely discharge any residual air pressure in the tool, and release the trigger before performing any inspection, maintenance, or cleaning procedures.

TO PREVENT SERIOUS INJURY:

Do not adjust or tamper with any control or component in a way not specifically explained within this manual. Improper adjustment can result in tool failure or other serious hazards.

Priming:

1. Remove the Base Cover (34) and use the Wrench (36) to unscrew and remove the Air Cylinder Cap (24) from the bottom of the Riveter.
2. Use a pair of pliers (not included) to grasp the Nut (23) and remove the Piston Head (22) from the Air Cylinder (19).
3. Hold the Air Cylinder upside down, and pour in hydraulic fluid (not included). The fill level should only reach the top of the Housing (11).
4. Insert the Piston Head back into the Air Cylinder.
5. Use the Wrench to firmly screw the Air Cylinder Cap back onto the Air Cylinder.
6. Replace the Base Cover.

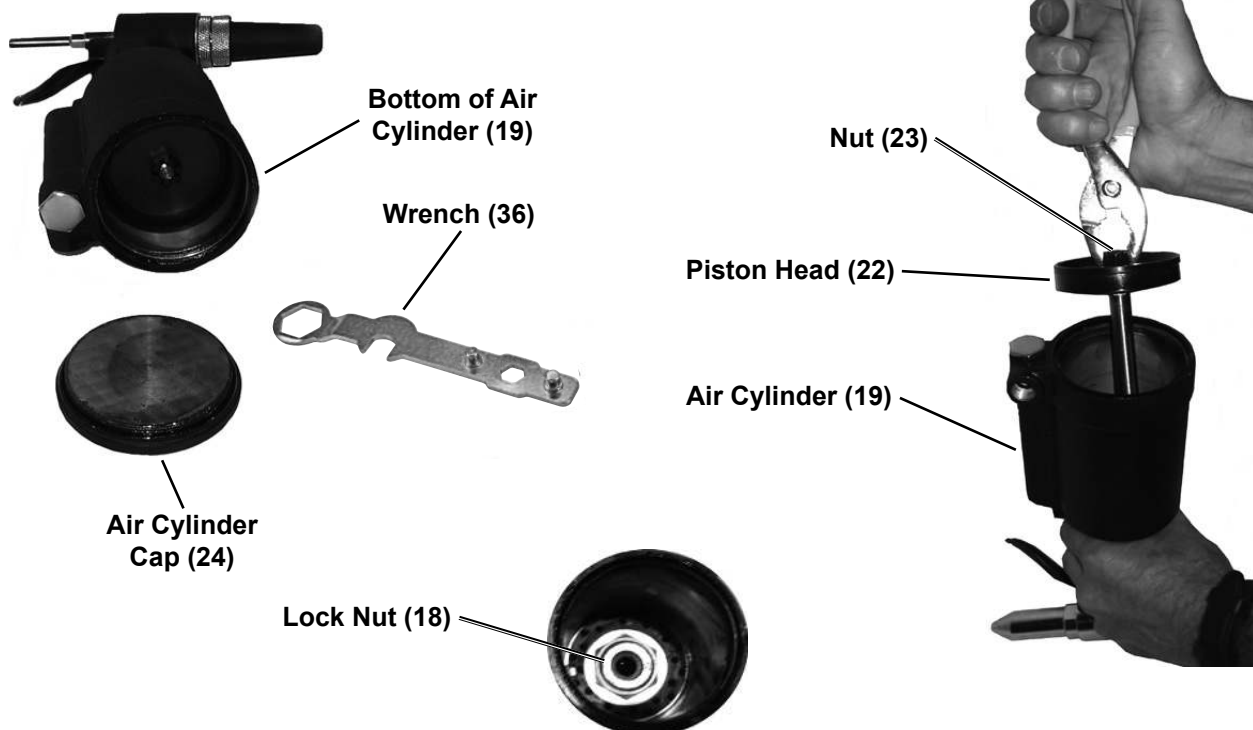

Figure C: Priming the Cylinder

Nosepieces:

1. The Riveter comes with *four* Nosepieces: (1A = 1/4"), (1B = 3/16"), (1C = 5/32"), (1D = 1/8"). Nosepieces are stored in the Air Cylinder Cap.
2. Use the Wrench (36) to remove the old nosepiece and install the new one. Tighten the new nosepiece in place before use.

Workpiece and Work Area Set Up

1. Designate a work area that is clean and well-lit. The work area must not allow access by children or pets to prevent distraction and injury.
2. Route the air hose along a safe route to reach the work area without creating a tripping hazard or exposing the air hose to possible damage. The air hose must be long enough to reach the work area with enough extra length to allow free movement while working.
3. Secure loose workpieces using a vise or clamps (not included) to prevent movement while working.
4. There must not be hazardous objects (such as utility lines or foreign objects) nearby that will present a hazard while working.

General Operating Instructions

1. If an automatic oiler is not used, add a few drops of Pneumatic Tool Oil to the airline connection before use. Add a few drops more after each hour of continual use.
 2. Secure the Pin Cap (C01) firmly to the Riveter by tightening the Pin Cap Nut (C02). While securing, turn the slot in the Pin Cap upward to avoid spilling used rivet pins.
 3. Depending on the size of rivet's pin used, attach the corresponding Nosepiece size (1/8", 5/32", 3/16", or 1/4") with the Wrench (36).
- IMPORTANT:** When drilling rivet holes in a workpiece, use the same diameter drill bit as the outer diameter of rivet being used.
- WARNING! TO PREVENT SERIOUS INJURY:** Verify that work surface has no hidden utility lines before drilling.
4. Attach an air hose to the Air Inlet of the Riveter.
 5. Turn on the air compressor, and set its regulator to the needed pressure. **Do not exceed the tool's maximum air pressure rating.**
 6. Insert the small end of a rivet fully through the Nosepiece (1A, 1B, 1C, or 1D).
CAUTION! Keep clear of the trigger when inserting rivets.
 7. Insert the rivet through the predrilled hole in the workpiece.
 8. Hold the Riveter firmly against the workpiece with both hands, and squeeze the Trigger (25) to activate the Riveter. Repeat as necessary. Then, release pressure on the Trigger.
 9. Check to be sure the rivet looks soild and securely locks the workpiece together.
 - If the installed rivet is too loose then the workpiece sections will move and not be locked together. This indicates the rivet pin was not adequately pulled through the workpiece. Either the wrong size rivet was used or Riveter's Jaw Case is too loose and not gripping the rivet pin well enough to pull it fully through the workpiece.
 - A concave, deformed or broken rivet head indicates the rivet pin was pulled too far into the workpiece. Either the wrong size rivet was used or Riveter's Jaw Case is too tight and not properly releasing the rivet pin during installation.
 10. If the tool requires more force to accomplish the task, verify that the tool receives sufficient, unobstructed airflow (CFM) and increase the pressure (PSI) output of the regulator up to the maximum air pressure rating of this tool.
- CAUTION! TO PREVENT INJURY FROM TOOL OR ACCESSORY FAILURE:**
Do not exceed the tool's maximum air pressure rating.
If the tool still does not have sufficient force at maximum pressure and sufficient airflow, then a larger tool may be required.
11. To prevent accidents, turn off the tool, detach the air supply, safely discharge any residual air pressure in the tool, and release the trigger after use. Clean external surfaces of the tool with clean, dry cloth, and apply a thin coat of tool oil. Then store the tool indoors out of children's reach.

CENTRALPNEUMATIC®

User-Maintenance Instructions



Procedures not specifically explained in this manual must be performed only by a qualified technician.

WARNING

TO PREVENT SERIOUS INJURY FROM ACCIDENTAL OPERATION:

Turn off the tool, detach the air supply, safely discharge any residual air pressure in the tool, and release the trigger before performing any inspection, maintenance, or cleaning procedures.

TO PREVENT SERIOUS INJURY FROM TOOL FAILURE:

Do not use damaged equipment. If abnormal noise, vibration, or leaking air occurs, have the problem corrected before further use.



TO PREVENT SERIOUS INJURY FROM EXPLOSION:

Lubricate the tool only with specified lubricants. Lubricate the air inlet using only pneumatic tool oil. Other lubricants may damage the mechanism and may be highly flammable, causing an explosion.

Cleaning, Maintenance, and Lubrication

Note: These procedures are in addition to the regular checks and maintenance explained as part of the regular operation of the air-operated tool.

- BEFORE EACH USE**, inspect the general condition of the tool. Check for:
 - loose hardware or housing
 - misalignment or binding of moving parts
 - cracked or broken parts
 - any other condition that may affect its safe operation.
- Daily - Air Supply Maintenance:**
Every day, maintain the air supply according to the component manufacturers' instructions. Maintain the lubricator's oil level. Drain the moisture filter regularly. Performing routine air supply maintenance will allow the tool to operate more safely and will also reduce wear on the tool.
- Quarterly (every 3 months) – Tool Disassembly, Cleaning, and Inspection:**
Have the internal mechanism cleaned, inspected, and lubricated by a qualified technician.
- To clean the exterior of the Riveter, wipe with a clean, damp cloth using a mild detergent or mild solvent. Do not immerse the tool in liquids.

Jaw Cleaning and Replacement

- Unscrew and remove the Outer Cylinder (2) using the Wrench (36).
 - Unscrew and remove the Jaw Case (3) from the Jaw Cylinder (7). **Use care as there is a Jaw Pusher (5) and Jaw Pusher Spring (6) behind the Jaw Case which may fly out.**
 - Remove the Jaws (4) from the Jaw Case.
 - To clean the Jaws, use a steel brush and mild solvent. Then apply a light coat of machine oil to the Jaws and insert them back into the Jaw Case.
 - To replace the Jaws, insert the new set of Jaws into the Jaw Case.
 - Reattach the Jaw Case to the Jaw Cylinder.
- Important:** When reassembling the Jaw Case, line up the wedge on the Jaw Pusher's head in-between the Jaws, pushing them slightly apart.

Jaw Cleaning and Replacement (continued)

7. Check the distance from the head of the Jaw Case to the mounting threads of the Housing (11) using the Wrench Gauge.

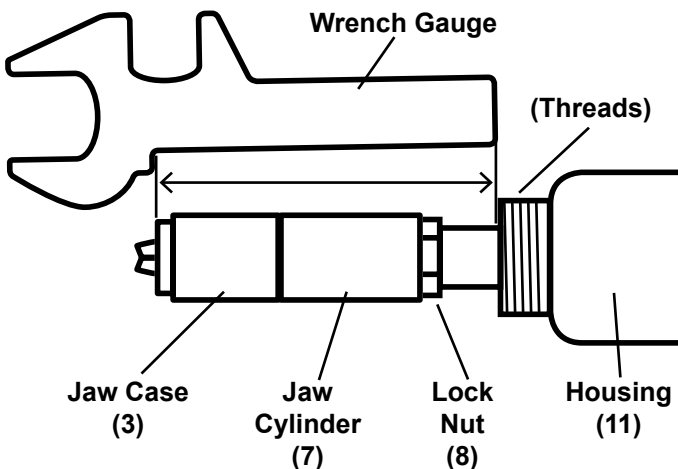

Figure D: Checking Jaw Case Tightness

8. With the gauge at a slight incline, the back of the gauge should rest on the end of the Housing threads, while the front of the gauge should rest on the front edge of the Jaw Case. If it does not, tighten/loosen the Jaw Case until the distance is corrected. Refer to Figure D.

NOTE: Use the included Wrench Gauge as a general guideline only. Jaw Case tightness must be fine-tuned to the application, rivet supplier, etc.

9. Before reassembly, secure the Lock Nut (8) against the Jaw Cylinder using the Wrench Gauge.
10. Replace the Outer Cylinder and tighten using the Wrench.

Troubleshooting

Problem	Possible Causes	Likely Solutions
Jaws slipping.	Worn or damaged Jaws.	Replace Jaws.
Jaws will not open.	1. Loose Nosepiece. 2. Dirty Jaws.	1. Tighten Nosepiece. 2. Clean Jaws.
Stroke is too short.	1. Rivet pin not properly inserted into Riveter. 2. Low hydraulic fluid. 3. Rivet wrong size.	1. Fully insert pin. 2. Prime Riveter—see page 10. 3. Use proper rivet length.
Weak pulling action.	1. Low air pressure. 2. Broken/inadequate air compressor. 3. Low hydraulic fluid.	1. Check regulator. 2. Have compressor serviced by a qualified technician/upgrade to compressor of sufficient capability. 3. Prime Riveter—see page 10.
Leaking air.	1. Poor hose connections. 2. Damaged O-Ring. 3. Dirty Air Valve or airline inlet.	1. Reconnect using pipe thread seal tape. 2. Replace O-Ring. 3. Clean and lubricate with pneumatic tool oil.
Workpiece not tightly held together by rivet.	Rivet pin not pulled far enough through workpiece.	Tighten Riveter's Jaw Case and use proper size rivet.
Rivet head deformed in workpiece.	Rivet pin not properly released during installation.	Loosen Riveter's Jaw Case and use proper size rivet.



**Follow all safety precautions whenever diagnosing or servicing the tool.
Disconnect air supply before service.**

PLEASE READ THE FOLLOWING CAREFULLY

THE MANUFACTURER AND/OR DISTRIBUTOR HAS PROVIDED THE PARTS LIST AND ASSEMBLY DIAGRAM IN THIS MANUAL AS A REFERENCE TOOL ONLY. NEITHER THE MANUFACTURER OR DISTRIBUTOR MAKES ANY REPRESENTATION OR WARRANTY OF ANY KIND TO THE BUYER THAT HE OR SHE IS QUALIFIED TO MAKE ANY REPAIRS TO THE PRODUCT, OR THAT HE OR SHE IS QUALIFIED TO REPLACE ANY PARTS OF THE PRODUCT. IN FACT, THE MANUFACTURER AND/OR DISTRIBUTOR EXPRESSLY STATES THAT ALL REPAIRS AND PARTS REPLACEMENTS SHOULD BE UNDERTAKEN BY CERTIFIED AND LICENSED TECHNICIANS, AND NOT BY THE BUYER. THE BUYER ASSUMES ALL RISK AND LIABILITY ARISING OUT OF HIS OR HER REPAIRS TO THE ORIGINAL PRODUCT OR REPLACEMENT PARTS THERETO, OR ARISING OUT OF HIS OR HER INSTALLATION OF REPLACEMENT PARTS THERETO.

Parts List

Part	Description	Qty
1A	1/4" Nosepiece	1
1B	3/16" Nosepiece*	1
1C	5/32" Nosepiece*	1
1D	1/8" Nosepiece*	1
2	Outer Cylinder	1
3	Jaw Case	1
4	Jaws	1Set
5	Jaw Pusher	1
6	Jaw Push Spring	1
7	Jaw Cylinder	1
8	Lock Nut	1
9	Principal Axis	1Set
10	Ring	1
11	Housing	1
12	Restore Spring	1
13	Ring	1
14	Restore Spring	1
15	Steel Ring	1
16	Airtight Lid	1
17	Silencer	1
18	Lock Nut	1
19	Air Cylinder	1
20	Pole Piston	1
21	Cushion	1
22	Piston Head	1
23	Nut	1
24	Cylinder Cap	1

Part	Description	Qty
25	Trigger	1
26	Linker	1
27	Press Plank	1
28	Air Valve	1
29	Valve Spring	1
30	Copper Wash	1
31	Valve	1
32	Spring	1
33	Nut	1
34	Base Cover	1
36	3-Way Wrench*	1
37	Combination Wrench*	1
B01	O Ring	2
B02	O Ring	1
B03	O Ring	1
B04	O Ring	2
B05	O Ring	1
B06	Spring Pin	1
B07	Spring Pin	2
B08	Spring Pin	1
B09	Spring Pin	1
B10	O Ring	1
B11	O Ring	1
B12	O Ring	1
B13	O Ring	1
C01	Pin Cap	1
C02	Pin Cap Nut	1

* not shown.

Record Product's Serial Number Here: _____

Note: If product has no serial number, record month and year of purchase instead.

Note: Some parts are listed and shown for illustration purposes only, and are not available individually as replacement parts. Specify UPC 792363626859 when ordering parts.

Limited 90 Day Warranty

Harbor Freight Tools Co. makes every effort to assure that its products meet high quality and durability standards, and warrants to the original purchaser that this product is free from defects in materials and workmanship for the period of 90 days from the date of purchase. This warranty does not apply to damage due directly or indirectly, to misuse, abuse, negligence or accidents, repairs or alterations outside our facilities, criminal activity, improper installation, normal wear and tear, or to lack of maintenance. We shall in no event be liable for death, injuries to persons or property, or for incidental, contingent, special or consequential damages arising from the use of our product. Some states do not allow the exclusion or limitation of incidental or consequential damages, so the above limitation of exclusion may not apply to you. THIS WARRANTY IS EXPRESSLY IN LIEU OF ALL OTHER WARRANTIES, EXPRESS OR IMPLIED, INCLUDING THE WARRANTIES OF MERCHANTABILITY AND FITNESS.

To take advantage of this warranty, the product or part must be returned to us with transportation charges prepaid. Proof of purchase date and an explanation of the complaint must accompany the merchandise. If our inspection verifies the defect, we will either repair or replace the product at our election or we may elect to refund the purchase price if we cannot readily and quickly provide you with a replacement. We will return repaired products at our expense, but if we determine there is no defect, or that the defect resulted from causes not within the scope of our warranty, then you must bear the cost of returning the product.

This warranty gives you specific legal rights and you may also have other rights which vary from state to state.

CENTRALPNEUMATIC®

26541 Agoura Road • Calabasas, CA 91302 • 1-888-866-5797