

# *DrayTek*

## Vigor Router 11ax Series



QUICK START GUIDE

V1.0



# **Vigor Router 11ax Series**

## **Quick Start Guide**

**Version: 1.0**

**Firmware Version: V4.4.2**

**(For future update, please visit DrayTek web site)**

**Date: March 14, 2022**

## Intellectual Property Rights (IPR) Information

<b>Copyrights</b>	© All rights reserved. This publication contains information that is protected by copyright. No part may be reproduced, transmitted, transcribed, stored in a retrieval system, or translated into any language without written permission from the copyright holders.
<b>Trademarks</b>	The following trademarks are used in this document: <ul style="list-style-type: none"><li>● Microsoft is a registered trademark of Microsoft Corp.</li><li>● Windows, Windows 95, 98, Me, NT, 2000, XP, Vista, 7, 8 and Explorer are trademarks of Microsoft Corp.</li><li>● Apple and Mac OS are registered trademarks of Apple Inc.</li><li>● Other products may be trademarks or registered trademarks of their respective manufacturers.</li></ul>

## Safety Instructions and Approval

<b>Safety Instructions</b>	<ul style="list-style-type: none"><li>● Read the installation guide thoroughly before you set up the router.</li><li>● The router is a complicated electronic unit that may be repaired only by authorized and qualified personnel. Do not try to open or repair the router yourself.</li><li>● Do not place the router in a damp or humid place, e.g. a bathroom.</li><li>● Do not stack the routers.</li><li>● The router should be used in a sheltered area, within a temperature range of 0 to +40 Celsius.</li><li>● Do not expose the router to direct sunlight or other heat sources. The housing and electronic components may be damaged by direct sunlight or heat sources.</li><li>● Do not deploy the cable for LAN connection outdoor to prevent electronic shock hazards.</li><li>● Keep the package out of reach of children.</li><li>● When you want to dispose of the router, please follow local regulations on conservation of the environment.</li></ul>
<b>Warranty</b>	We warrant to the original end user (purchaser) that the router will be free from any defects in workmanship or materials for a period of two (2) years from the date of purchase from the dealer. Please keep your purchase receipt in a safe place as it serves as proof of date of purchase. During the warranty period, and upon proof of purchase, should the product have indications of failure due to faulty workmanship and/ or materials, we will, at our discretion, repair or replace the defective products or components, without charge for either parts or labor, to whatever extent we deem necessary to restore the product to proper operating condition. Any replacement will consist of a new or re-manufactured functionally equivalent product of equal value, and will be offered solely at our discretion. This warranty will not apply if the product is modified, misused, tampered with, damaged by an act of God, or subjected to abnormal working conditions. The warranty does not cover the bundled or licensed software of other vendors. Defects which do not significantly affect the usability of the product will not be covered by the warranty. We reserve the right to revise the manual and online documentation and to make changes from time to time in the contents hereof without obligation to notify any person of such revision or changes.



## Declaration of Conformity

Hereby, DrayTek Corporation declares that the radio equipment type Vigor2135ax, Vigor2765ax, Vigor2766ax series router is in compliance with Directive 2014/ 53/ EU.

The full text of the EU declaration of conformity is available at the following internet address:

<https://www.draytek.com.tw/ftp/Vigor2765ax/Document/CE/>

<https://www.draytek.com.tw/ftp/Vigor2766ax/Document/CE/>

<https://www.draytek.com.tw/ftp/Vigor2135ax/Document/CE/>

Manufacturer: DrayTek Corp.

Address: No. 26, Fushing Rd., Hukou, Hsinchu Industrial Park, Hsinchu 303, Taiwan

Product: Vigor2135ax, Vigor2765ax, Vigor2766ax series router

Frequency Information for Europe area:

2.4G WLAN	2412MHz - 2472 MHz, max. TX power: 19.98dBm	*1
5G WLAN	5160MHz - 5340 MHz, max. TX power: 22 dBm 5480MHz - 5720 MHz, max. TX power: 27 dBm	*2
	Requirements in AT/ BE/ BG/ CZ/ DZ/ DK/ EE/ FR/ DE/ IS/ IE/ IT/ EL/ ES/ CY/ LV/ LI/ LT/ LU/ HU/ MT/ NL/ NO/ PL/ PT/ RO/ SI/ SK/ TR/ FI/ SE/ CH/ HR. 5150MHz~5350MHz is for indoor use only.	

(\*1: for 2.4G WLAN model; \*2: for 5G WLAN model)

This product is designed for DSL and 2.4GHz / 5GHz WLAN network throughout the EC region.



## Declaration of Conformity

Hereby, DrayTek Corporation declares that the radio equipment type Vigor2135ax, Vigor2765ax, Vigor2766ax series router is in compliance with Regulation SI 2017 No. 1206.

The full text of the UKCA Declaration of Conformity is available at the following internet address:

<https://www.draytek.com.tw/ftp/Vigor2765ax/Document/UKCA/>

<https://www.draytek.com.tw/ftp/Vigor2766ax/Document/UKCA/>

<https://www.draytek.com.tw/ftp/Vigor2135ax/Document/UKCA/>

Manufacturer: DrayTek Corp.

Address: No. 26, Fushing Rd., Hukou, Hsinchu Industrial Park, Hsinchu 303, Taiwan

Product: Vigor2135ax, Vigor2765ax, Vigor2766ax series router

Importer: SEG, 11 Capital Business Park, Borehamwood, Herts, WD6 1GW

Frequency Information for UK area:

2.4G WLAN	2412MHz - 2472 MHz, max. TX power: 19.79dBm	*1
5G WLAN	5160MHz - 5340 MHz, max. TX power: 22.74dBm 5480MHz - 5720 MHz, max. TX power: 29.88dBm	*2
	Requirements in UK. 5150MHz~5350MHz is for indoor use only.	

(\*1: for 2.4G WLAN model; \*2: for 5G WLAN model)

This product is designed for DSL and 2.4GHz / 5GHz WLAN network use in the UK & Ireland.



## Regulatory Information

### Federal Communication Commission Interference Statement

This equipment has been tested and found to comply with the limits for a Class B digital device, pursuant to Part 15 of the FCC Rules. These limits are designed to provide reasonable protection against harmful interference in a residential installation. This equipment generates, uses and can radiate radio frequency energy and, if not installed and used in accordance with the instructions, may cause harmful interference to radio communications. However, there is no guarantee that interference will not occur in a particular installation. If this equipment does cause harmful interference to radio or television reception, which can be determined by turning the equipment off and on, the user is encouraged to try to correct the interference by one of the following measures:

- Reorient or relocate the receiving antenna.
- Increase the separation between the equipment and receiver.
- Connect the equipment into an outlet on a circuit different from that to which the receiver is connected.
- Consult the dealer or an experienced radio/ TV technician for help.

This device complies with Part 15 of the FCC Rules. Operation is subject to the following two conditions:

- (1) This device may not cause harmful interference, and
- (2) This device may accept any interference received, including interference that may cause undesired operation.

### RF Exposure Warning

This equipment must be installed and operated in accordance with provided instructions and the antenna(s) used for this transmitter must be installed to provide a separation distance of at least 20 cm from all persons and must not be co-located or operating in conjunction with any other antenna or transmitter. End-users and installers must be provided with antenna installation instructions and transmitter operating conditions for satisfying RF exposure compliance.

USA Local Representative	Company name	ABP International Inc.		
	Address	13988 Diplomat Drive Suite 180 Dallas TX 75234		
	ZIP Code	75234	E-mail	rmesser@abptech.com
	Contact Person	Mr. Robert Messer	Tel.	19728311600

### Caution

Any changes or modifications not expressly approved by the grantee of this device could void the user's authority to operate the equipment.

The antenna/ transmitter should be kept at least 20 cm away from human body.



More update, please visit [www.draytek.com](http://www.draytek.com).

## ***Table of Contents***

<b>1. Package Content .....</b>	<b>1</b>
<b>2. Panel Explanation.....</b>	<b>2</b>
2.1 Broadband Router - Vigor2135ax, Vigor2135Vax .....	2
2.2 35b Security Router - Vigor2765ax, Vigor2765Vax.....	4
2.3 G.Fast Security Router - Vigor2766ax, Vigor2766Vax .....	6
<b>3. Hardware Installation .....</b>	<b>8</b>
3.1 Network Connection .....	8
3.2 Wall-Mounted Installation .....	9
<b>4. Software Configuration .....</b>	<b>10</b>
<b>5. Customer Service .....</b>	<b>15</b>
Be a Registered Owner .....	15
Firmware & Tools Updates .....	15

# 1. Package Content

Take a look at the package content. If there is anything missed or damaged, please contact DrayTek or dealer immediately.



Router

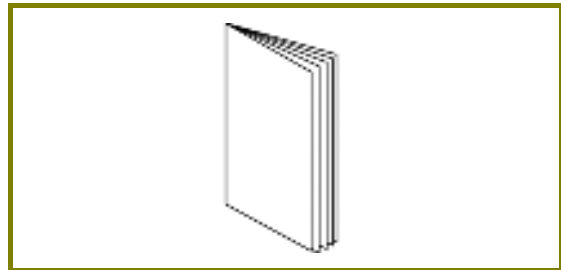

Quick Start Guide

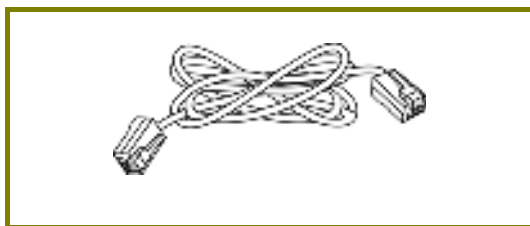

RJ-45 Cable (Ethernet)

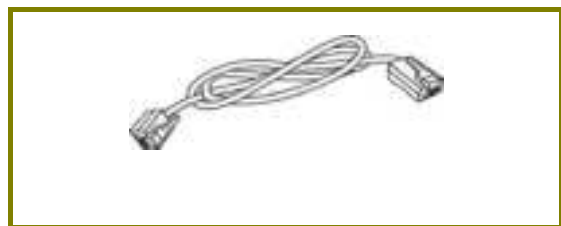

RJ-11 to RJ-11 Cable (Annex A)  
RJ45 to RJ45 Cable (Annex B)  
RJ11 to RJ45 Cable (Annex B)

The type of the power adapter depends on the country that the router will be installed. \* The maximum power consumption is **27.6 Watt**.

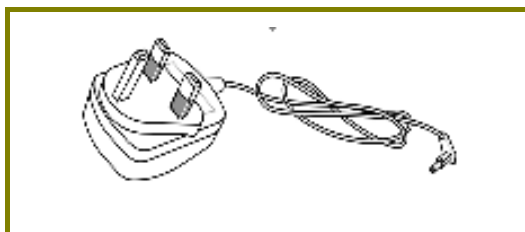

UK-type power adapter

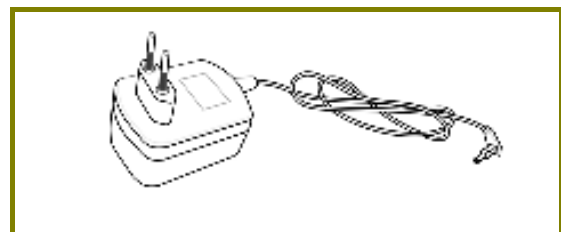

EU-type power adapter

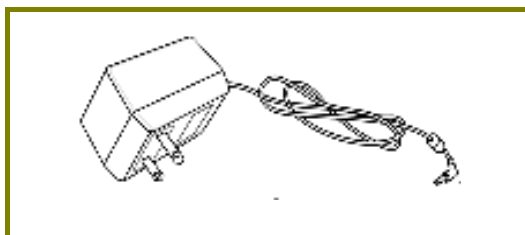

USA/ Taiwan-type power adapter

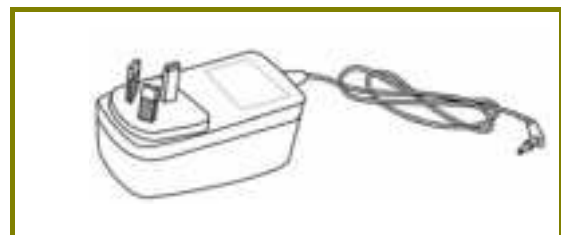





AU/ NZ-type Power Adapter







## 2. Panel Explanation

### 2.1 Broadband Router - Vigor2135ax, Vigor2135Vax



LED	Status	Explanation
 ACT	Off	The system is not ready or is failed.
	Blinking	The system is ready and can work normally.
	Blinking with WLAN	WPS is enabled and waiting for the response from the wireless client.
 WAN	On	Internet connection is ready.
	Blinking	The data is transmitting.
	Off	Internet connection is not ready.
 WLAN	Off	Wireless function is not ready.
	On	Wireless function is ready.
	Blinking	Data is transmitting (sending/ receiving).
	Blinking with WLAN	WPS is enabled and waiting for the response from the wireless client.
 USB	On	A USB device is connected and active.
	Blinking	The data is transmitting.
 (for "V" model)	On	The phone connected to this port is off-hook.
	Off	The phone connected to this port is on-hook.
	Blinking	A phone call comes.







Interface	Description
WLAN ON/ OFF WPS	Wireless band will be switched / changed according to the button pressed and released. For example, <ul style="list-style-type: none"> <li>● 2.4G (On) and 5G (On) –in default.</li> <li>● 2.4G (Off) and 5G (On) –pressed and released the button once.</li> <li>● 2.4G (On) and 5G (Off) –pressed and released the button twice.</li> <li>● 2.4G (Off) and 5G (Off) –pressed and released the button three times.</li> </ul> WPS - When WPS function is enabled by web user interface, press this button for more than 2 seconds. The router will wait for any wireless client connecting to it through WPS.
	Power switch.
	PWR: Connector for a power adapter.
 Phone2/ 1	(for “V” model) Connector of analog phone for VoIP communication.
 LAN P4-P1	Connectors for local networked devices. <ul style="list-style-type: none"> <li>● Left LED on - The port is connected.</li> <li>● Left LED off - The port is disconnected.</li> <li>● Left LED Blinking - The data is transmitting.</li> <li>● Right LED on -The port is connected with 1000Mbps.</li> <li>● Right LED off - The port is connected with 10/ 100 Mbps.</li> </ul>
 WAN	Connector for accessing the Internet. <ul style="list-style-type: none"> <li>● Left LED on - The port is connected.</li> <li>● Left LED off - The port is disconnected.</li> <li>● Left LED Blinking - The data is transmitting.</li> <li>● Right LED on -The port is connected with 1000Mbps.</li> <li>● Right LED off - The port is connected with 10/ 100 Mbps.</li> </ul>
 USB	Connector for USB devices (for 3G/ 4G USB Modem or printer).
Factory Reset	Restore the default settings. Usage: Turn on the router. Press the button and keep for more than 10 seconds. Then the router will restart with the factory default configuration.









## 2.2 35b Security Router - Vigor2765ax, Vigor2765Vax



Vigor2765ax

Vigor2765Vax

LED	Status	Explanation	
 ACT	Off	The system is not ready or is failed.	
	Blinking	The system is ready and can work normally.	
	Blinking with WLAN	WPS is enabled and waiting for the response from the wireless client.	
 DSL	Orange	On	The DSL link up, waiting for the Internet connection.
		Blinking	Slowly - The DSL connection is ready for training. Quickly - The DSL connection is synchronizing.
	Green	On	The router is ready to access to the Internet through DSL link.
		Blinking	The data is transmitting.
 WLAN	Off	Wireless function is not ready.	
	On	Wireless function is ready.	
	Blinking	Data is transmitting (sending/ receiving).	
	Blinking with WLAN	WPS is enabled and waiting for the response from the wireless client.	
 USB	On	A USB device is connected and active.	
	Blinking	The data is transmitting.	
 (for "V" model)	On	The phone connected to this port is off-hook.	
	Off	The phone connected to this port is on-hook.	
	Blinking	A phone call comes.	



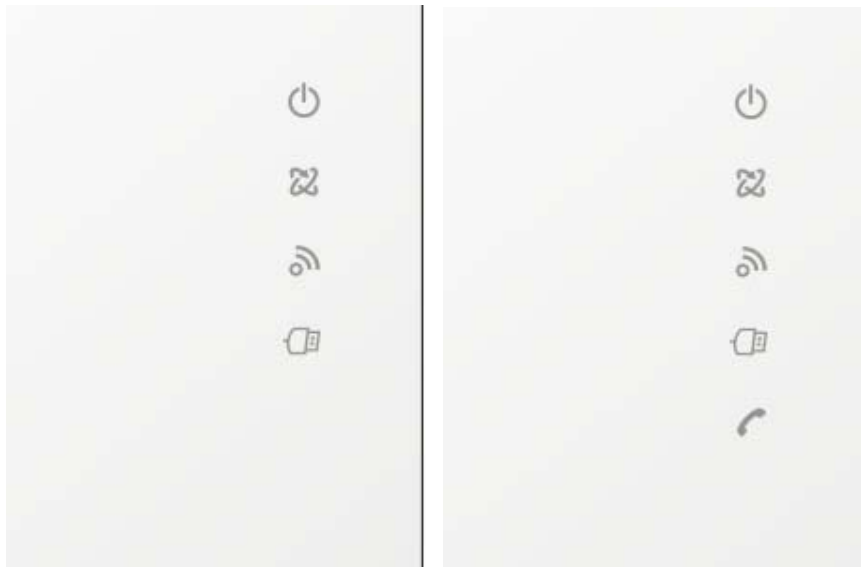

Interface	Description
 <p>WLAN ON/ OFF WPS</p>	<p>Wireless band will be switched / changed according to the button pressed and released. For example,</p> <ul style="list-style-type: none"> <li>● 2.4G (On) and 5G (On) –in default.</li> <li>● 2.4G (Off) and 5G (On) –pressed and released the button once.</li> <li>● 2.4G (On) and 5G (Off) –pressed and released the button twice.</li> <li>● 2.4G (Off) and 5G (Off) –pressed and released the button three times.</li> </ul> <p>WPS - When WPS function is enabled by web user interface, press this button for more than 2 seconds. The router will wait for any wireless client connecting to it through WPS.</p>
	<p>Power switch.</p>
	<p>PWR: Connector for a power adapter.</p>
 <p>Phone2/ 1</p>	<p>(for “V” model) Connector of analog phone for VoIP communication.</p>
 <p>LAN P4-P1</p>	<p>Connectors for local networked devices.</p> <ul style="list-style-type: none"> <li>● Left LED on - The port is connected.</li> <li>● Left LED off - The port is disconnected.</li> <li>● Left LED Blinking - The data is transmitting.</li> <li>● Right LED on -The port is connected with 1000Mbps.</li> <li>● Right LED off - The port is connected with 10/ 100 Mbps.</li> </ul>
 <p>DSL</p>	<p>Connector for accessing the Internet.</p>
 <p>USB</p>	<p>Connector for a USB device (for 3G/ 4G USB Modem or printer).</p>
 <p>Factory Reset</p>	<p>Restore the default settings. Usage: Turn on the router. Press the button and keep for more than 10 seconds. Then the router will restart with the factory default configuration.</p>









## 2.3 G.Fast Security Router - Vigor2766ax, Vigor2766Vax



Vigor2766ax

Vigor2766Vax

LED	Status	Explanation	
	Off	The system is not ready or is failed.	
	Blinking	The system is ready and can work normally.	
	Blinking with WLAN	WPS is enabled and waiting for the response from the wireless client.	
	Orange	On	The DSL link up, waiting for the Internet connection.
		Blinking	Slowly - The DSL connection is ready for training. Quickly - The DSL connection is synchronizing.
	Green	On	The router is ready to access to the Internet through DSL link.
		Blinking	The data is transmitting.
	Off	Wireless function is not ready.	
	On	Wireless function is ready.	
	Blinking	Data is transmitting (sending/ receiving).	
	Blinking with WLAN	WPS is enabled and waiting for the response from the wireless client.	
	On	A USB device is connected and active.	
	Blinking	The data is transmitting.	
 (for "V" model)	On	The phone connected to this port is off-hook.	
	Off	The phone connected to this port is on-hook.	
	Blinking	A phone call comes.	

Interface	Description
 <p>WLAN ON/ OFF WPS</p>	<p>Wireless band will be switched / changed according to the button pressed and released. For example,</p> <ul style="list-style-type: none"> <li>● 2.4G (On) and 5G (On) –in default.</li> <li>● 2.4G (Off) and 5G (On) –pressed and released the button once.</li> <li>● 2.4G (On) and 5G (Off) –pressed and released the button twice.</li> <li>● 2.4G (Off) and 5G (Off) –pressed and released the button three times.</li> </ul> <p>WPS - When WPS function is enabled by web user interface, press this button for more than 2 seconds. The router will wait for any wireless client connecting to it through WPS.</p>
	<p>Power switch.</p>
	<p>PWR: Connector for a power adapter.</p>
 <p>Phone2/ 1</p>	<p>(for “V” model) Connector of analog phone for VoIP communication.</p>
 <p>LAN P4-P1</p>	<p>Connectors for local networked devices.</p> <ul style="list-style-type: none"> <li>● Left LED on - The port is connected.</li> <li>● Left LED off - The port is disconnected.</li> <li>● Left LED Blinking - The data is transmitting.</li> <li>● Right LED on -The port is connected with 1000Mbps.</li> <li>● Right LED off - The port is connected with 10/ 100 Mbps.</li> </ul>
 <p>DSL</p>	<p>Connector for accessing the Internet.</p>
 <p>USB</p>	<p>Connector for a USB device (for 3G/ 4G USB Modem or printer).</p>
 <p>Factory Reset</p>	<p>Restore the default settings. Usage: Turn on the router. Press the button and keep for more than 10 seconds. Then the router will restart with the factory default configuration.</p>

## 3. Hardware Installation

This section will guide you to install the router through hardware connection and configure the router's settings through web browser.

Before starting to configure the router, you have to connect your devices correctly.

### 3.1 Network Connection

1. Connect the DSL interface to the land line jack with a DSL line cable.
2. Connect one port of 4-port switch to your computer with a RJ-45 cable. This device allows you to connect 4 PCs directly.
3. Connect one end of the power cord to the power port of this device. Connect the other end to the wall outlet of electricity.
4. Power on the router.
5. Check the ACT and WAN/ DSL LEDs to assure network connection.

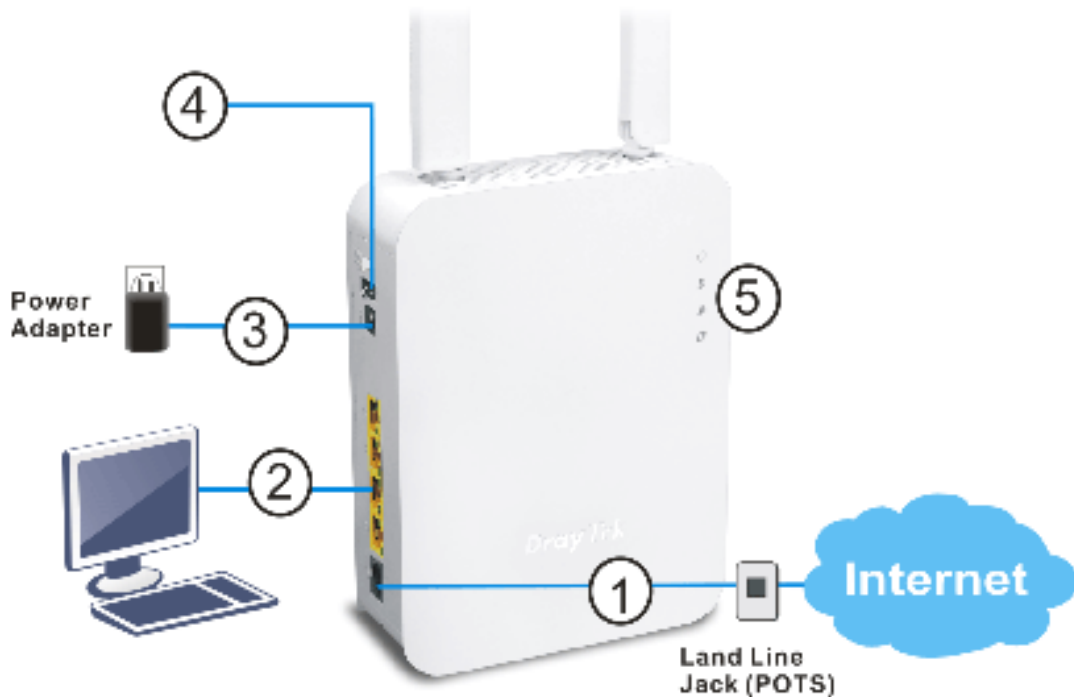

(Here we take Vigor2765ax as an example.)

### 3.2 Wall-Mounted Installation

Vigor router has keyhole type mounting slots on the underside.

1. Drill two holes on the wall. The distance between the holes shall be 100.75mm. The recommended drill diameter shall be 6.5mm (1/4").
2. Fit screws into the wall using the appropriate type of screw plug.
3. Hang the Vigor router directly onto the screws.

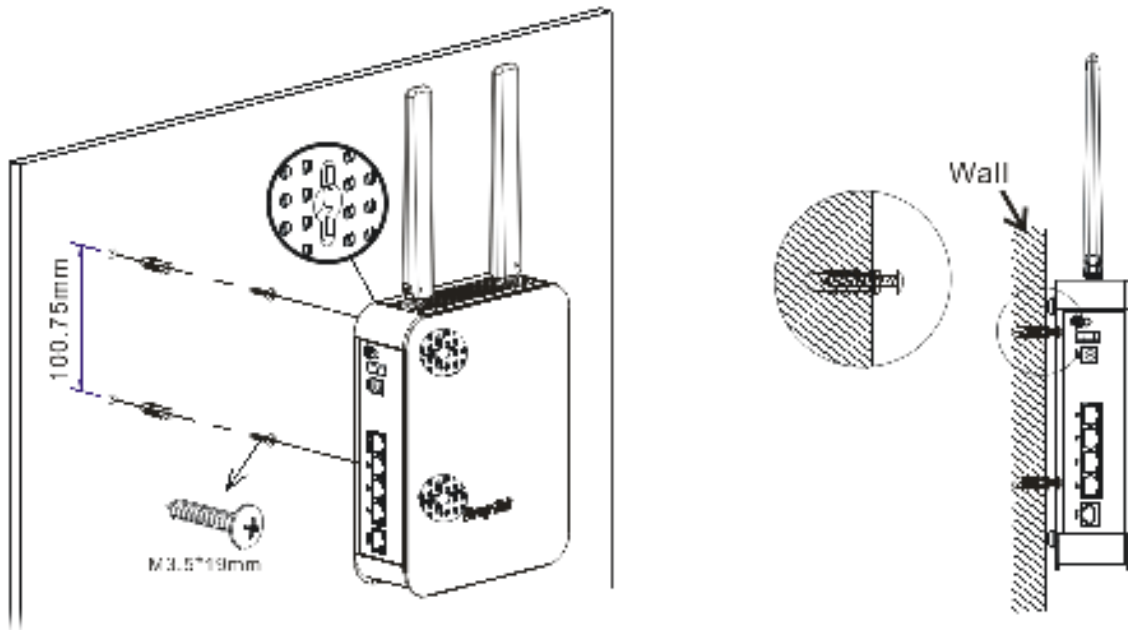

(Here we take Vigor2765ax as an example.)

## 4. Software Configuration

To access Internet, please finish basic configuration after completing the hardware installation.

The **Quick Start Wizard** is designed for you to easily set up your router for Internet access. You can directly access the **Quick Start Wizard** via Web Configurator.

Make sure your PC connects to the router correctly.



---

### Note

You may either simply set up your computer to get IP dynamically from the router or set up the IP address of the computer to be the same subnet as **the default IP address of Vigor router 192.168.1.1**. For the detailed information, please refer to the section - Trouble Shooting in the User's Guide.

---

Open a web browser on your PC and type **https://192.168.1.1**. A pop-up window will open to ask for username and password. Please type "admin/ admin" as the Username/ Password and click **Login**. Here, we take Vigor2766Vax series as an example.

**DrayTek** **Vigor2766 Series**

**Login**

Username

Password

**Security Warning: You are logging in without encryption which is not recommended. To login securely [click here](#).**

Copyright© 2000-2022 DrayTek Corp. All Rights Reserved.

Now, the **Main Screen** will pop up. Click **Wizards**>>**Quick Start Wizard**.



**Note**

The home page will change slightly in accordance with the router you have.

The first screen of **Quick Start Wizard** is entering login password. After typing the password, please click **Next**.

**Wizards** >> **Quick Start Wizard**

**Enter login password**

Please enter an alphanumeric string as your Password (Max 33 characters)

Old Password

New Password

Confirm Password

Password Strength

Strong password requirements

1. Have at least one upper case letter and one lower case letter.
2. Including non-alphanumeric characters is a plus

Hint: If you want to keep the password unchanged, leave the password blank and press "Next" button to skip this process.

On the next page as shown below, please select the WAN interface that you use. If DSL interface is used, please choose WAN1; if Ethernet interface is used, please choose WAN2; if 3G USB modem is used, please choose WAN3. Then click **Next** for next step. WAN1, WAN2 and WAN3 will bring up different configuration page. Here, we take **WAN1** (ADSL/ VDSL2) as an example.

**Quick Start Wizard**

Select WAN Interface

Select WAN Interface:	WAN1
Display Name:	
Physical Mode:	ADSL / VDSL2 / G.fast
DSL Mode:	Auto
Physical type:	Auto negotiation
VLAN Tag insertion(ADSL):	Disable
Tag value:	(0-4095)
Priority:	(0-7)
VLAN Tag insertion(VDSL2/G.fast):	Disable
Tag value:	(0-4095)
Priority:	(0-7)

On the next page as shown below, please select the appropriate protocol **according to the information from your ISP**. For example, you should select PPPoE mode if the ISP provides you PPPoE interface. Then click **Next** for next step.

**PPPoE/PPPoA**

1. Choose **WAN1** as WAN Interface and click the **Next** button; you will get the following page.

Wizards >> Quick Start Wizard

Connect to Internet

WAN 1

Protocol	PPPoE / PPPoA
For ADSL Only:	
Encapsulation	PPPoE / L2TP
VPI	0 <input type="button" value="Auto detect"/>
VCI	20
Fixed IP	<input type="radio"/> Yes <input checked="" type="radio"/> No(Dynamic IP)
IP Address	192.168.25.10
Subnet Mask	255.255.255.0
Default Gateway	192.168.25.1
Primary DNS	8.8.8.8
Second DNS	0.0.4.4

2. After finished the above settings, simply click **Next**.

Wizards >> Quick Start Wizard

Set PPPoL / PPPoA

WAN 1	
Service Name (optional)	2785
Username	04205755@hinet.net
Password	*****
Confirm Password	*****

[< Back](#) [Next >](#) [Finish](#) [Cancel](#)

3. Please manually enter the Username/ Password provided by your ISP. Then click **Next** for viewing summary of such connection.

Wizards >> Quick Start Wizard

Please confirm your settings

WAN Interface	WAN1
Physical Mode:	ADSL / VDSL2 / G.fast
VPI	0
VCI	30
Protocol / Encapsulation	PPPoE / L2C
Local IP:	No
Primary DNS	8.8.8.8
Secondary DNS:	0.0.0.0

[< Back](#) [Next >](#) [Finish](#) [Cancel](#)

4. Click **Finish**. A page of **Quick Start Wizard Setup OK!!!** will appear. Then, the system status of this protocol will be shown.
5. Now, you can enjoy surfing on the Internet.

## MPoA / Static or Dynamic IP

1. Choose **WAN1** as WAN Interface and click the **Next** button; you will get the following page.

Wizards => Quick Start Wizard

Connect to Internet

<b>WAN 1</b>	
Protocol	MPoA / Static or Dynamic IP
<hr/>	
For ADSL Only:	
Encapsulation	1483 Bridged IP LLC
VPI	0      Auto detect
VCI	30
Fixed IP	<input type="radio"/> Yes <input checked="" type="radio"/> No (Dynamic IP)
IP Address	192.168.25.10
Subnet Mask	255.255.255.0
Default Gateway	192.168.25.1
Primary DNS	8.8.8.8
Second DNS	0.0.4.4

2. Please enter the IP address/ mask/ gateway information originally provided by your ISP. Then click **Next** for viewing summary of such connection.

Wizards => Quick Start Wizard

Please confirm your settings:

WAN Interface:	WAN1
Physical Mode:	ADSL / VDSL 2 / Cable
VPI:	0
VCI:	30
Protocol / Encapsulation:	1483 Bridged IP LLC
Fixed IP:	No
Primary DNS:	8.8.8.8
Secondary DNS:	0.0.4.4

3. Click **Finish**. A page of **Quick Start Wizard Setup OK!!!** will appear. Then, the system status of this protocol will be shown.
4. Now, you can enjoy surfing on the Internet.

## 5. Customer Service

If the router cannot work correctly after trying many efforts, please contact your dealer/ DrayTek for further help right away. For any questions, please feel free to send e-mail to “support@draytek.com”.

### **Be a Registered Owner**

Web registration is preferred. You can register your Vigor router via <https://myvigor.draytek.com>.

### **Firmware & Tools Updates**

Due to the continuous evolution of DrayTek technology, all routers will be regularly upgraded. Please consult the DrayTek web site for more information on newest firmware, tools and documents.

<https://www.draytek.com>