

048-MS-12 series
048-MS-18 series
048-MS-24 series
048-MS-36 series

DELLA



Instruction Package

This package contains information you need to install and use your product. Keep the package for future reference.

Installation Guide Contents

Warning and Safety -----	05
Installation Information -----	06
Name of Parts -----	08
Pre-installation -----	10
Indoor Unit Installation -----	11
Outdoor Unit Installation -----	17
Check List -----	22
Test Run -----	22
Finishing Touch -----	23

Operation Manual Contents

Warning and Safety -----	26
Product Specification -----	28
Parts Details -----	32
Remote Control -----	33
Operation Instructions -----	35
Wi-fi / App Connection -----	46
Care and Maintenance -----	52
Troubleshooting -----	54
Disposal Guideline -----	57

048-MS-12 series
048-MS-18 series
048-MS-24 series
048-MS-36 series

DELLA



Installation Guide

This guide contains all the information you need to install your product.

Warning and Safety

*Read this guide before installation. Failure to follow the safety instructions may result in property damage, serious injury or death.

DANGER

Indicates an **imminently** hazardous situation that, if not avoided, will result in death, serious injury, or serious property damage.

WARNING

Indicates a **potentially** hazardous situation that, if not avoided, will result in death, serious injury, or serious property damage.

CAUTION

Indicates a **potentially** hazardous situation that, if not avoided, will result in minor to moderate injury. It may also be used to indicate unsafe practices.

WARNING

- Check if there is any refrigerant leakage during installation. Refrigerants can be toxic and flammable. Rapid evaporation of refrigerant may cause frostbite, cardiac arrhythmia, and/or irritation.
- Do not install the appliance within 50cm of flammable substances such as alcohol, etc. Or pressurized containers such as spray cans.
- The appliance must be installed in accordance with applicable federal, state, and local regulations.
- Ensure that the power supply voltage corresponds to that stamped on the rating plate.
- Do not bend, tug, or compress the power cord during installation to prevent damaging the power cord. The electrical cord should be replaced by a qualified electrician.
- Do not use power extensions and/or multi-socket modules for appliance installation.
- Do not alter, change, or modify the appliance.
- A fuse or overload protection device with a suitable capacity for the indoor unit must be installed.
- The appliance must be fitted with means for disconnection from the main power supply under over-voltage category III conditions. All electrical wiring must follow federal, state, and local regulations.
- Do not place the appliance in contact with water. The electrical insulation could be damaged and thus cause electric shock.
- When working on the electric terminals, make sure the appliance is disconnected from the power supply.
- Make sure the appliance is properly grounded to prevent electric shock.

CAUTION

- Prevent children from accessing the working area during installation to prevent unforeseeable accidents.
- The base of the outdoor unit must be firmly fixed.
- Carry out a test run after the installation.
- Installing a mini split AC requires specialized training and equipment. Hire a licensed professional if not familiar with electrical wiring and HVAC systems.
- The packaging materials are recyclable and should be disposed of in separate waste bins.
- The appliance should not be installed in a location where the air outlet of the indoor or outdoor units is obstructed. Obstructions of these openings may cause damage or failures to the appliance.

Installation Information

Power Cord Requirement

	Cable Type
Outdoor Power Supply Cable	H07RN-F / H05RN-F
Interconnection Cord	H07RN-F / H05RN-F

Power Cord Minimum Cross Sectional Area (North America)	
Appliance Amp (A)	AWG
10	18
13	16
18	14
25	12
30	10
40	8

Power Cord Minimum Cross Sectional Area (Other Regions)	
Appliance Amp (A)	Nominal Cross Sectional Area (mm ²)
>3 and ≤6	0.75
>6 and ≤10	1
>10 and ≤16	1.5
>16 and ≤25	2.5
>25 and ≤32	4
>32 and ≤40	6

NOTE:

- Maximum current and product specifications are located on the side panels of the unit.

Installation Information

Torque Parameters

Pipe Size	Newton Meter (N-M)
1/4" (Ø6.35)	15 - 25
3/8" (Ø9.52)	35 - 40
1/2" (Ø12)	45 - 60
5/8" (Ø15.88)	73 - 78
3/4" (Ø19.05)	75 - 80

Pipe Length and Additional Refrigerant

Piping Length	Additional Refrigerant (R410A) Charge
≤16.4ft	No additional refrigerant needed
16.4ft - 49.2ft (≤12000 Btu)	20g/m
16.4ft - 49.2ft (≥18000 Btu)	30g/m

Name of Parts

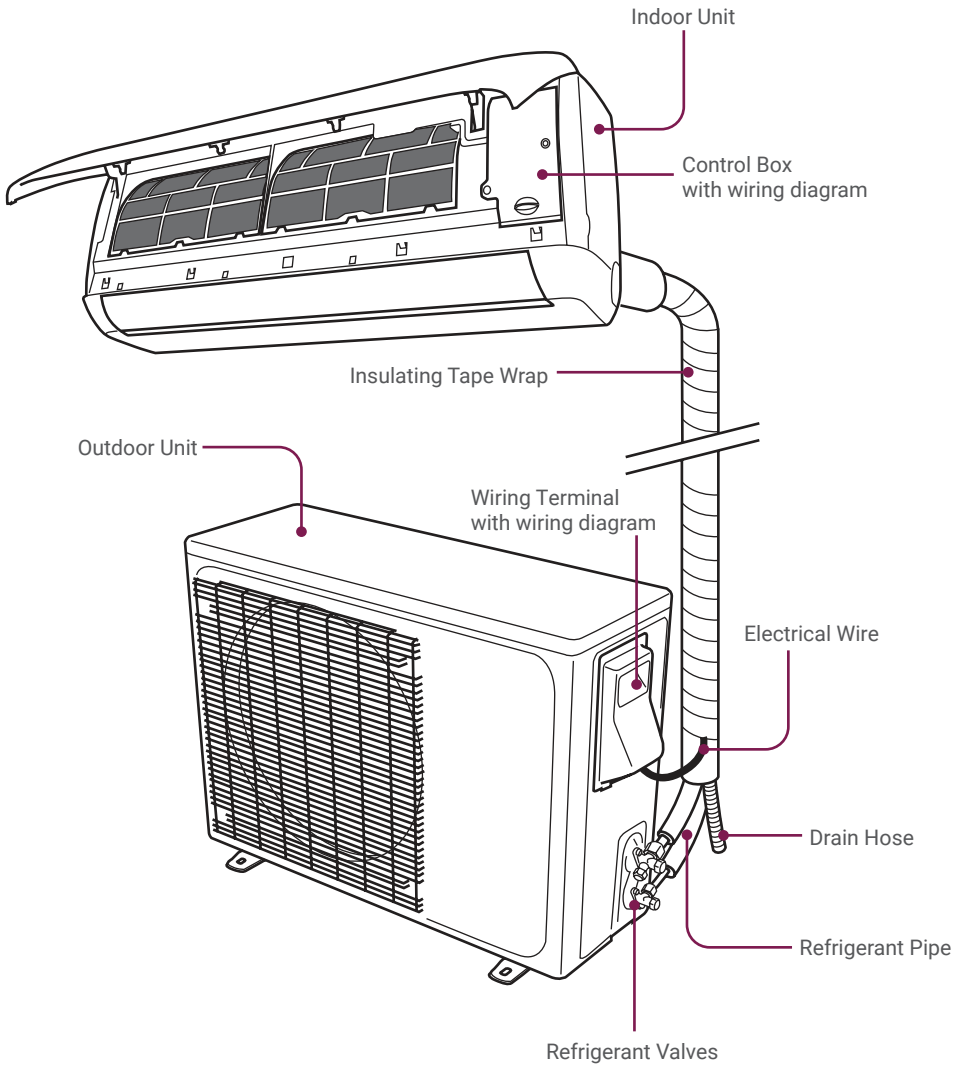

Name of Parts

Included Accessories

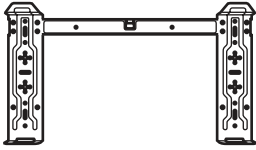

Mounting Plate
1x



Electrical Wire
3x



Insulation Wrap
1x

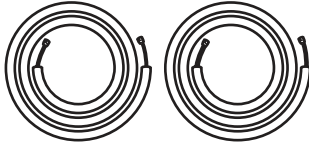

Refrigerant Pipe
2x

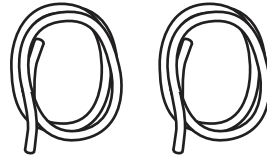

Drain Hose
2x



Wall Cover
1x



Plasticine Putty
1x



Remote Control
1x

Tools needed (not included)

- Screw Driver
- Hole Saw Ø70mm
- Refrigerant Leak Detector / Liquid Leak Detector
- Allen Wrench
- Spanner
- Torque Wrench
- Measuring Tape
- Spirit Level
- Stud Finder
- Thermometer
- Vacuum Pump
- Hollow Wall Anchors / Molly Bolts
- Wood Screws
- Wall Sleeve
- Floor Mounting Base Kit / Wall Mount Kit
- Ø25 Drainage Joint

Pre-installation

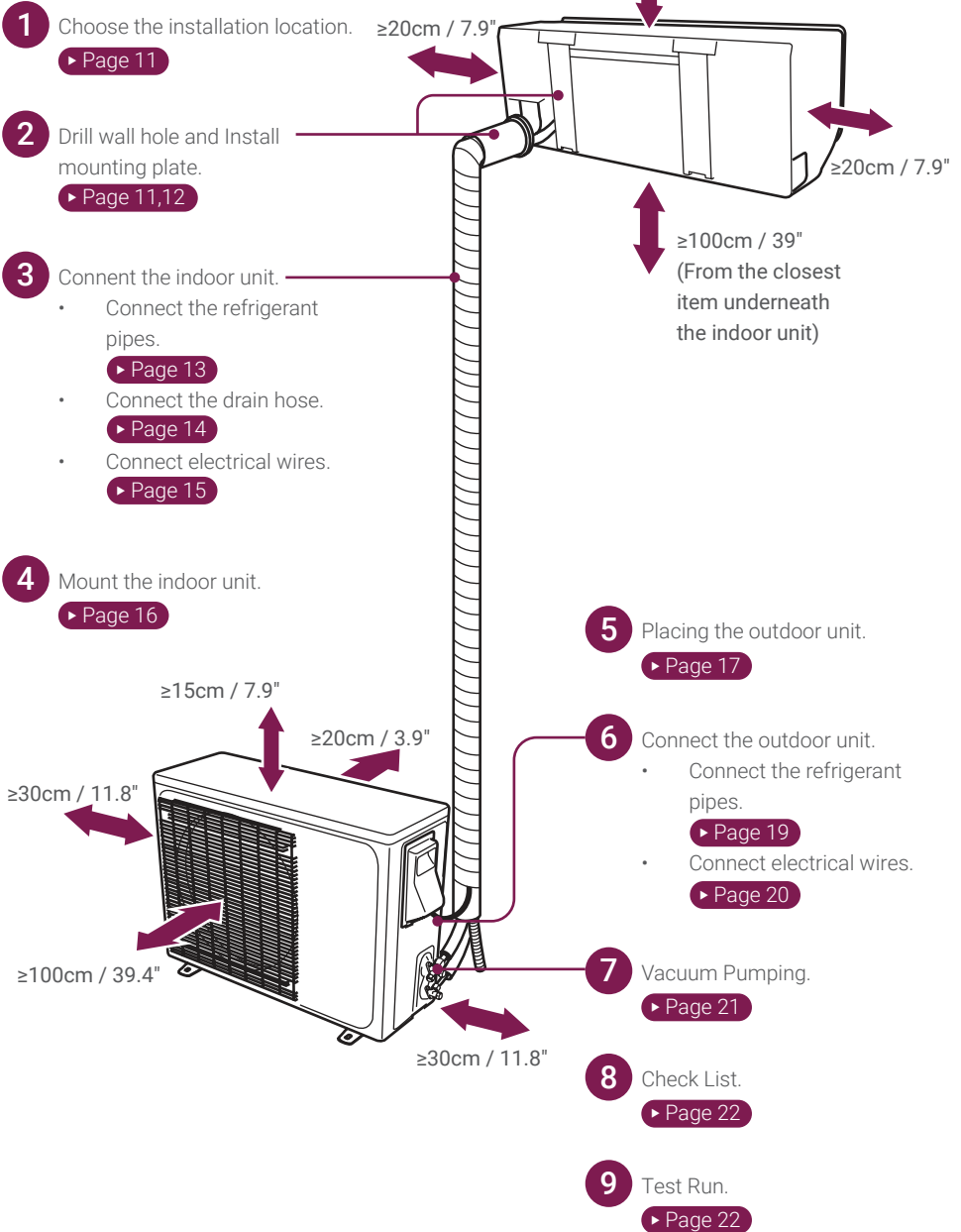

Indoor Unit Installation

Picking a Indoor Unit Instalalltion Location

- Make sure the air inlet and outlet are clear of any obstruction.
- Condensation can be easily drained.
- All connections can be easily made to the outdoor unit.
- Indoor unit is out of children's reach.
- Indoor unit is accessible for maintenance.
- Install 3m / 10ft away from TV or radio appliances.
(Radio interference may occur if appliances are placed too close to each other)
- Do not install in a laundry room or by a swimming pool.
- Ensure there is enough clearance space around the unit.

▶ Page 10

Install Mounting Bracket

1. Locate the studs and electrical wires inside the wall. Then measure the indoor unit dimensions and add the surrounding clearance space to determine the exact mounting location.
2. Use a spirit level to level the mounting plate on the wall. Then mark out the screw hole positions.

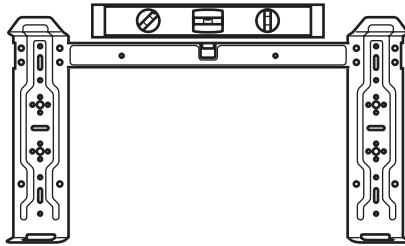

3. Drill holes in the wall, then insert wall anchors into the holes and affix the mounting plate to the wall using screws.

*Use a wood screw if the hole position is directly on a wood stud.

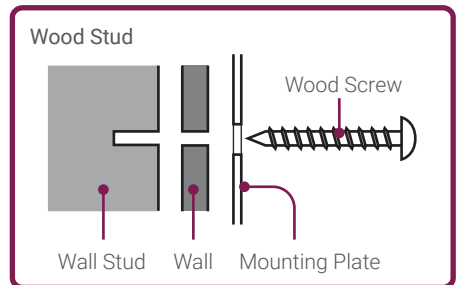
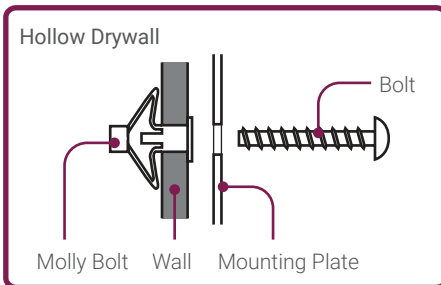

NOTE:

- You must use the correct wall anchor according to the type of the wall.

Indoor Unit Installation

Drill Wall Hole

1. Pick 1 of the 3 piping positions on your air conditioner.

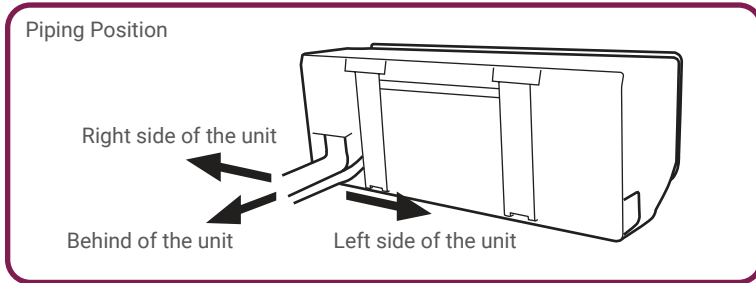

2. Mark a $\text{\O}70\text{mm}$ hole that goes from the indoor wall to the outdoor wall. The hole must be slanted downward with a small angle. And the position of the hole must be lower than the indoor unit drainage port.

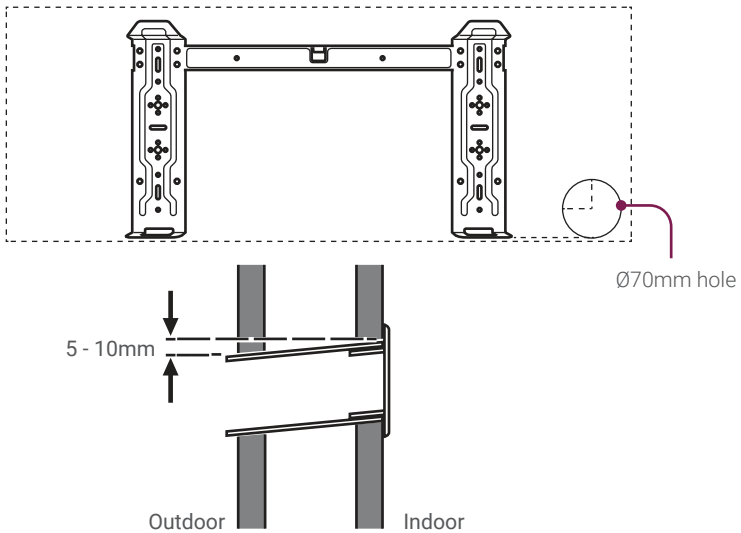

3. Drill the hole and insert the wall sleeve (not included) and sleeve cover into the hole.

NOTE:

- Make sure there is no building structure pillar, beam, strut, or any electrical wire, or water pipes in the way of the drill hole.
- Always insert the sleeve into the wall hole and seal the surrounding with putty if you are installing it on a hollow wall such as drywall or plaster walls. This will prevent water, insects, or small animals from getting into the wall.

⚠ WARNING

- Drilling into electrical wires or water pipes inside the wall may cause electric shock, fire, or water damage.

Indoor Unit Installation

Connect the Indoor Unit Refrigerant Pipes

1. Position the pipes of the indoor unit towards the wall holes. Cut off and trim the plastic cover on the unit if the pipes are positioned to the left or right side of the unit.
2. Unroll the included refrigerant pipes.

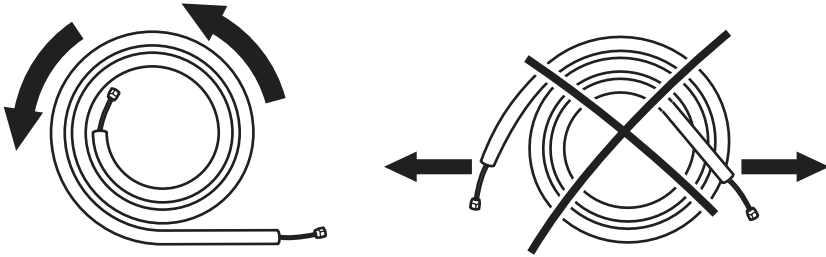

3. Remove the covers from the pipe ports and make sure the ports are clean and smooth.
4. Align the pipes to that from the indoor unit, then tighten the nut by hand.
5. Use a torque wrench to tighten the nut according to the requirement.

(Refer to installation information on [▶ Page 07](#).)

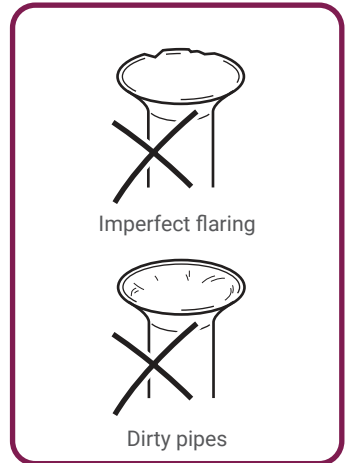
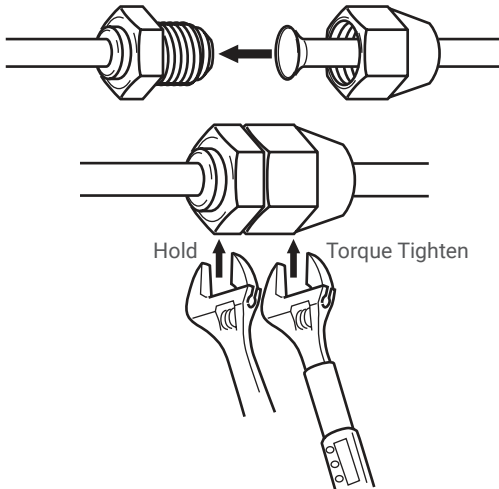

6. Wrap the joints with insulation tape.

NOTE:

- Carefully unroll the copper pipes and prevent kinking the pipes.
- Connection nuts must be tightened according to the torque requirement.

Indoor Unit Installation

Connect the Indoor Unit Drain Hose

1. Adjust the drainage hose in the indoor unit.
* In some models, drainage ports are available on both sides of the indoor unit. You can choose one side to attach the drain hose and insert a rubber plug on the unused port.
2. Connect the drain hose to the drainage port, make sure the joint is firmly connected and has a good seal.
3. Wrap the joint with Teflon tape to prevent any possible leak.

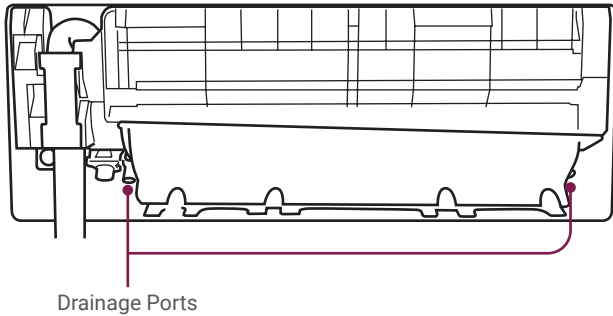

Drain Hose Installation

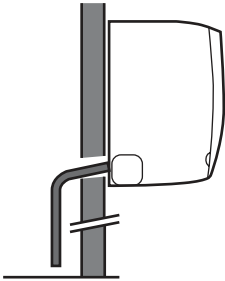

NOTE:

- Drain hose must be slanted downward and leave a small gap between the ground and the hose.

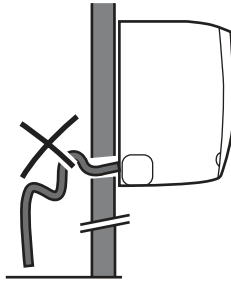

NOTE:

- Avoid having bends or dents on the drain hose.
- Do not leave the end of the hose into drainage gutter.

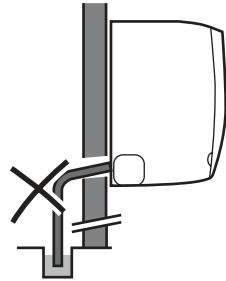

Indoor Unit Installation

Connect the Indoor Unit Electrical Wires

⚠ WARNING

- Electrical wiring must be done by a qualified technician or electrician. Failing to connect the wires correctly will cause short circuit, a fire, and property damage.

1. Choose the right cable size according to your model's maximum operating current. (Refer to installation information on [▶ Page 06](#) .)
2. Open the front panel of the indoor unit.
3. Use a screwdriver to open the electric control box cover and get access to the terminal block.
4. Unscrew the cable clamp
5. Insert one end of the wires from the back of the indoor unit to the terminal block.
6. Connect the wires to the corresponding terminal.
*Detailed electrical diagram is printed on the control box cover.
7. Screw the cable clamp and secure the wires in place.
8. Reinstall the control box cover and close the indoor unit's front panel.

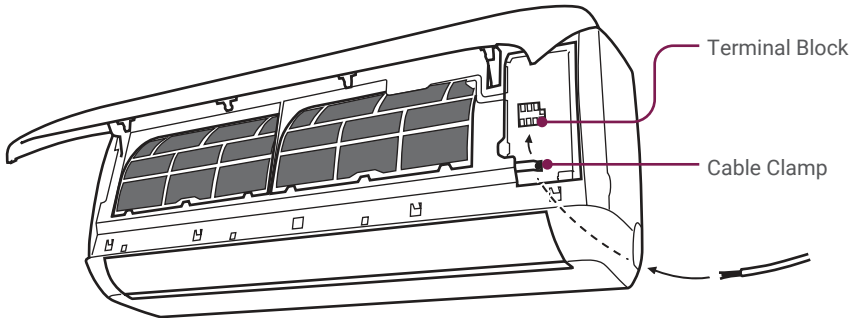

Indoor Unit Installation

Bundle the Pipes, Hose, and Wires

After connecting the refrigerant pipes, electrical wires, and drain hose, they must be bundled with insulating tape before passing them through the wall hole.

1. Arrange the pipes, hose, and wire cable according to the following image. Make sure the drain hose is positioned at the bottom and avoid crossing or tangling any parts.
2. Wrap the bundle with Insulation tape.

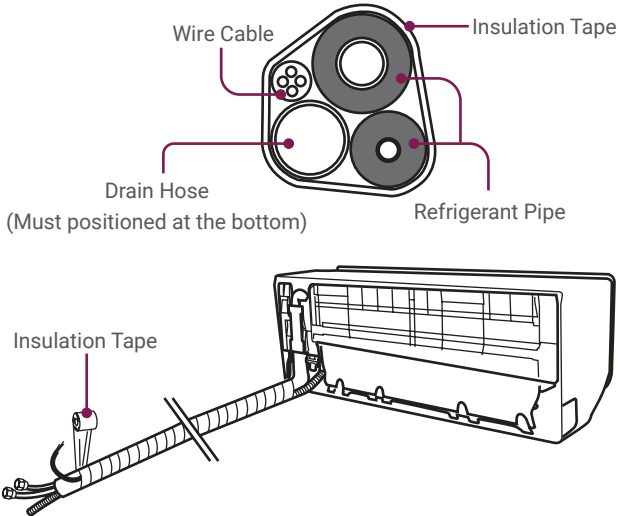

Mount the Indoor Unit

1. Carefully pass the pipes, hose, and cable bundle through the wall hole.
2. Hook the top of the indoor unit on the mounting plate.
3. Push the unit lightly left and right to make sure it is firmly hooked on the mounting plate.
4. Push down the bottom of the indoor unit and snap into the mounting plate.

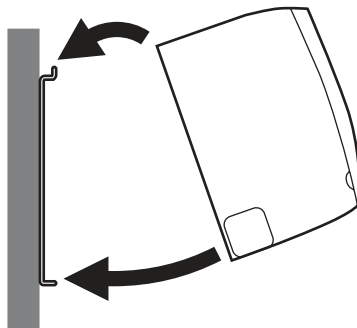

Outdoor Unit Installation

Placing the Outdoor Unit

- Do not install the outdoor unit near a heat source, steam, or flammable gas.
- Do not install the outdoor unit in windy or dusty locations.
- Do not install the outdoor unit in places where people often pass.
- Avoid installing the outdoor unit in places where it will be exposed to direct sunlight. (If necessary, build a protection that does not interfere with the airflow.)
- Make sure there is enough space around the outdoor unit to circulate air.
- Outdoor unit must be placed in a safe and solid location.
- The outdoor unit should ideally be placed on a concrete pad.
- Ensure there is enough clearance space around the unit.

▶ Page 10

Install Drainage Joint

1. Drainage joint (not included) is necessary for heating pump models.
2. Insert Ø25 drainage joint into the bottom hole of the outdoor unit.
3. Connect one end of the drain hose to the joint and the other end to the drainage point.

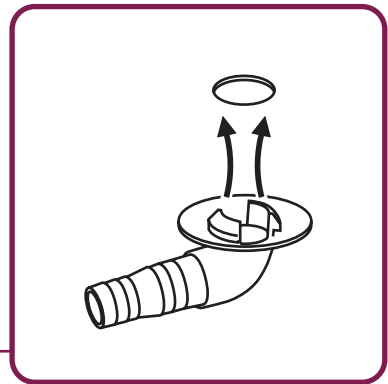
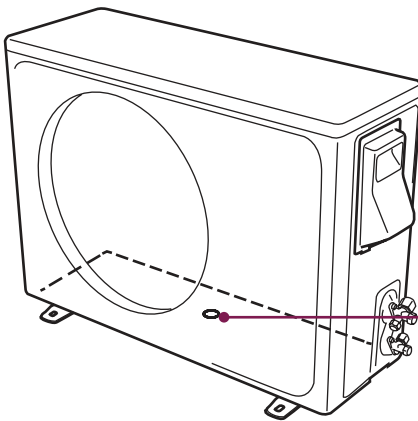

Outdoor Unit Installation

Secure the Outdoor Unit (Ground Installation)

1. Place a concrete pad on the installation location.
2. Mount the outdoor unit in a base kit or stand.
3. Drill holes on the concrete pad.
4. Secure the base kit or stand on the concrete pad with concrete anchor bolts.

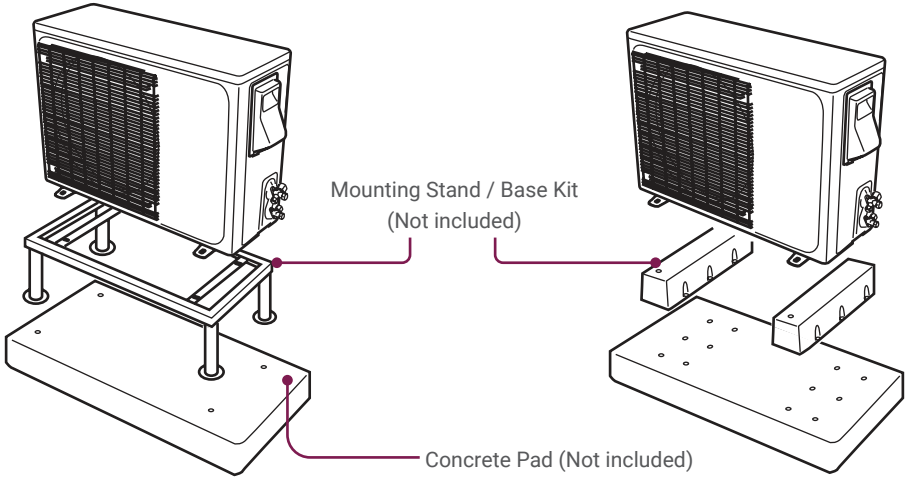

NOTE:

- Rubber foot pads can be placed between the outdoor unit and the mounting kit to reduce vibrations and noise.

Secure the Outdoor Unit (Wall Installation)

The outdoor unit can be fixed on a wall mounting bracket if there is no ground mounting option.

1. Measure the distance between the outdoor unit's legs.
2. Mount the wall mounting bracket on the wall.
3. Secure the outdoor unit on the wall mounting bracket.

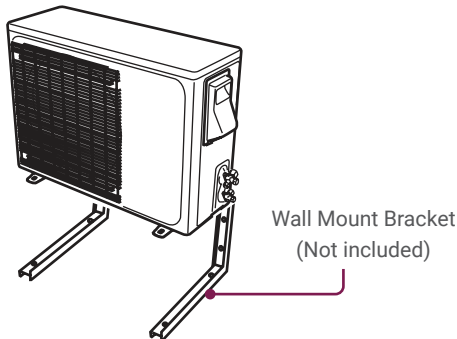

NOTE:

- The wall mounting bracket and the wall must be able to support at least 4 times the weight of the outdoor unit, or 441lb, whichever is heavier.

Outdoor Unit Installation

Connect the Outdoor Unit Refrigerant Pipes

1. Remove the plastic caps from the end of the valves.
2. Remove the covers from the pipe ports and make sure the ports are clean and smooth.
3. Align the pipes to the outdoor unit valve, then tighten the nut by hand.

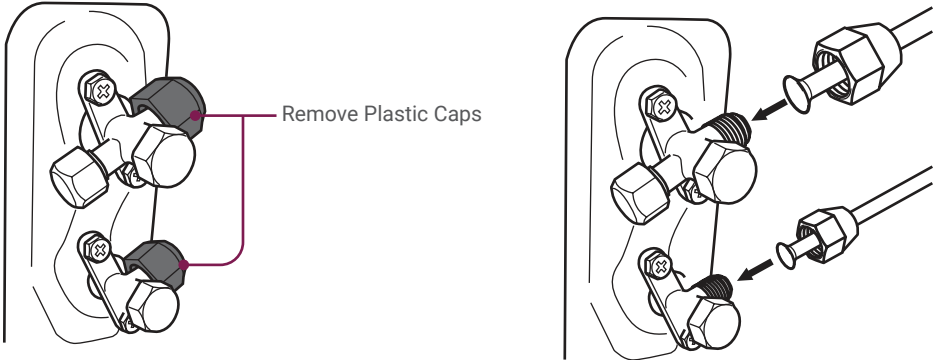

4. Use a torque wrench to tighten the nut according to the requirement.
(Refer to installation information on [▶ Page 07](#).)

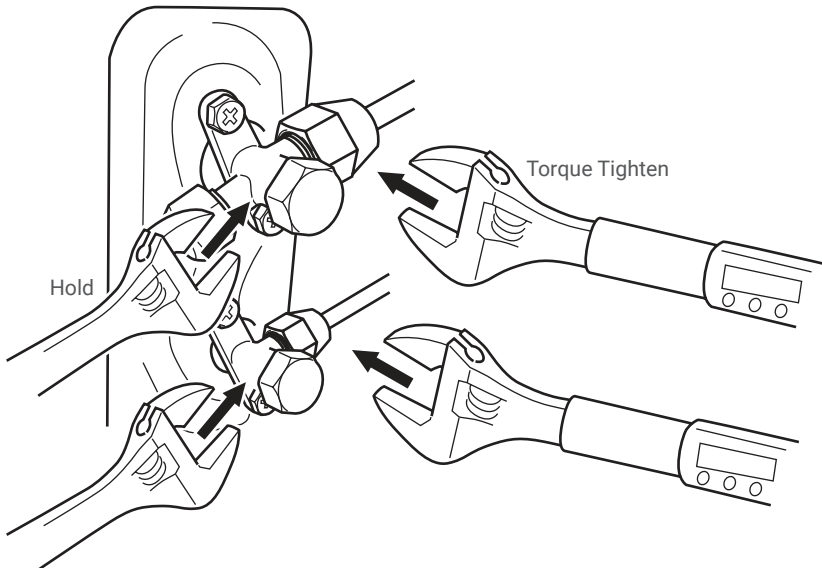

Outdoor Unit Installation

Connect Electrical Wire

1. Unscrew the screws from the wiring cover and remove it from the unit.
2. Unscrew the cable clamp.
3. Insert the electrical wires from the indoor unit through the opening on the cover, then connect the wire to the outdoor unit terminal.
*Detailed electrical diagram is printed on the back of the wiring cover.
4. Insert power supply wires to the opening on the cover, then connect the wire to the outdoor unit terminal.
*Detailed electrical diagram is printed on the back of the wiring cover.
5. Turn off any power from the power supply, and connect the wires to the power supply circuit box.
6. Reinstall the wiring cover to its original place.

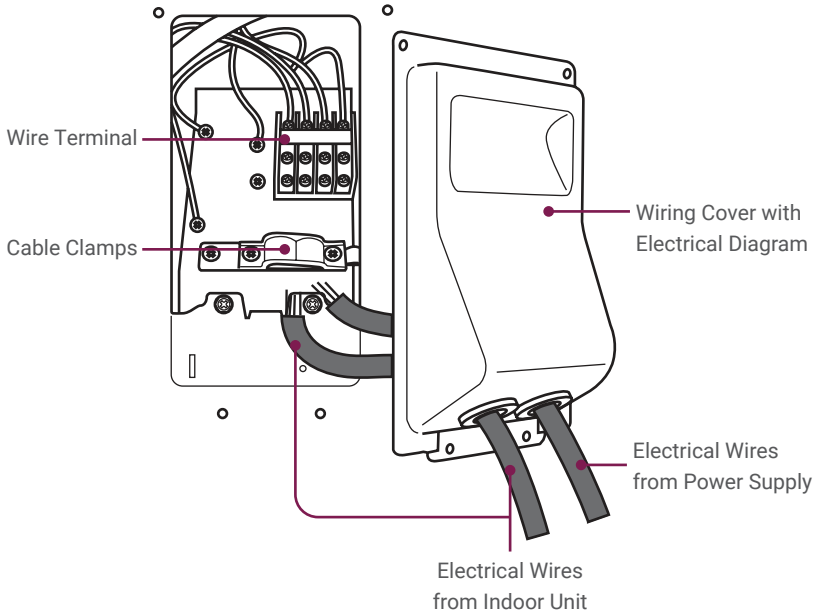

NOTE:

- Both the wires from the indoor unit and from the power supply must be grounded.

Outdoor Unit Installation

Vacuum Pumping and Leak Test

1. Remove the protective cap from the service port, low-pressure valve, and high-pressure valve.
2. Connect the pressure hose from the manifold gauge to the service port.
3. Connect the charge hose from the manifold gauge to the vacuum pump.

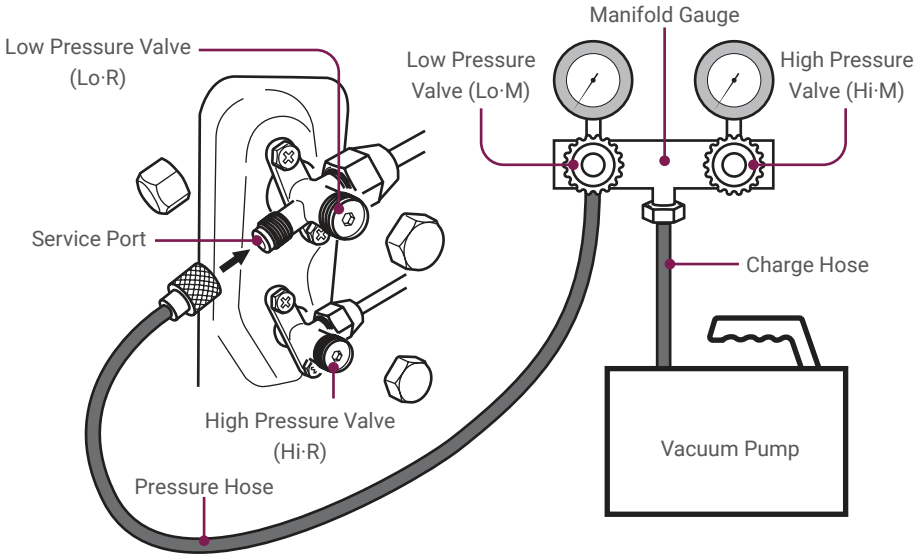

4. OPEN the low-pressure valve (Lo-M) and CLOSE the high-pressure valve (Hi-M) on the manifold gauge.
 5. Turn on the vacuum pump to vacuum the system.
 6. Let the vacuum pump run for at least 15 minutes and make sure the gauge indicates -0.1Mpa (-76cmHg).
 7. Close the pressure valve (Lo-M) and turn off the vacuum pump.
 8. Leave the system connected with the manifold gauge for 5 minutes, then make sure the gauge indication does not exceed 0.005Mpa .
* In the case of a leak, and the pressure value increases, reconnect all the connection joints on the refrigerant line, and redo the vacuum pumping.
 9. Open the high-pressure valve (Hi-R) for $1/4$ turn, then close the valve after 5 seconds.
 10. Check all the connection joints with a refrigerant leak detector or liquid leak detector.
 11. Add refrigerant charge if you use a lengthened refrigerant line.
- Page 07
12. Disconnect the pressure hose from the service port, then fully open the low-pressure valve (Lo-R) and high-pressure valve (Hi-R).
 13. Put the protective caps back on the service port, low-pressure valve, and high-pressure valve. Tighten the caps.

Check List

Go through the following list and check your installation.

the checkbox for each confirmation.

Task List	Status
Do the power supply and voltage match the unit rating ? (Check before connecting to the power supply)	<input type="checkbox"/>
Is the electrical wiring in the air conditioner connected and secured ?	<input type="checkbox"/>
Is the air conditioner properly grounded ?	<input type="checkbox"/>
Is the power breaker, fuse, or protection device installed ?	<input type="checkbox"/>
Is the indoor mounting plate secured ?	<input type="checkbox"/>
Is the draining hose properly attached ?	<input type="checkbox"/>
Are the refrigerant pipes securely connected and no refrigerant leakage ?	<input type="checkbox"/>
Are all the pipes, hoses, and wires bundled and wrapped with insulation tape ?	<input type="checkbox"/>
Are the refrigerant valves fully opened ?	<input type="checkbox"/>
Can the remote control send control commands to the air conditioner ?	<input type="checkbox"/>

NOTE:

- Any failures, accidents, or damages caused by improper installation are not covered by the warranty.

Test Run

1. Turn on the power supply.
2. Turn on the air conditioner using the remote control.
3. Test the unit at the lowest temperature in COOL mode.
4. Test the unit at the highest temperature in HEAT mode.
5. Test each mode for at least 8 minutes.
 - Measure the air temperature at the air outlet.
 - Check if water drains properly from the drainage hose.
 - Check if the louver and deflectors move properly.
6. If everything is operating normally, return to the normal setting and turn off the air conditioner.
7. Inform the user to read the operation manual before use, and demonstrate to the user how to use the air conditioner, the necessary knowledge of service and maintenance, and a reminder of accessories storage.

Finishing Touches

Complete the installation by sealing the opening in the wall and attaching a cover over the line bundle for added protection..

Install a decorative line cover kit (not included) over the line bundle to protect it from rain, sunlight, and other external elements.

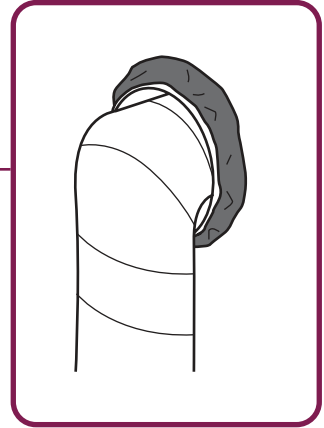
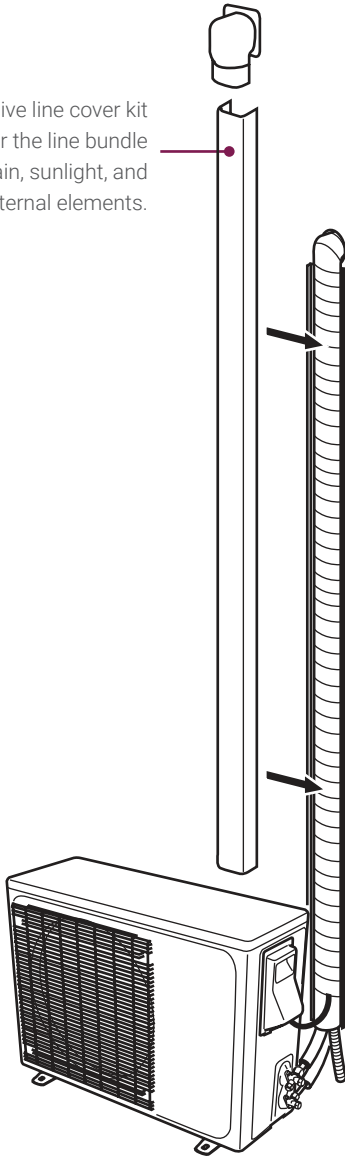

Seal the wall penetration with sealant / putty / caulk etc. (not included) to prevent water or insects from getting into the walls.

Memo

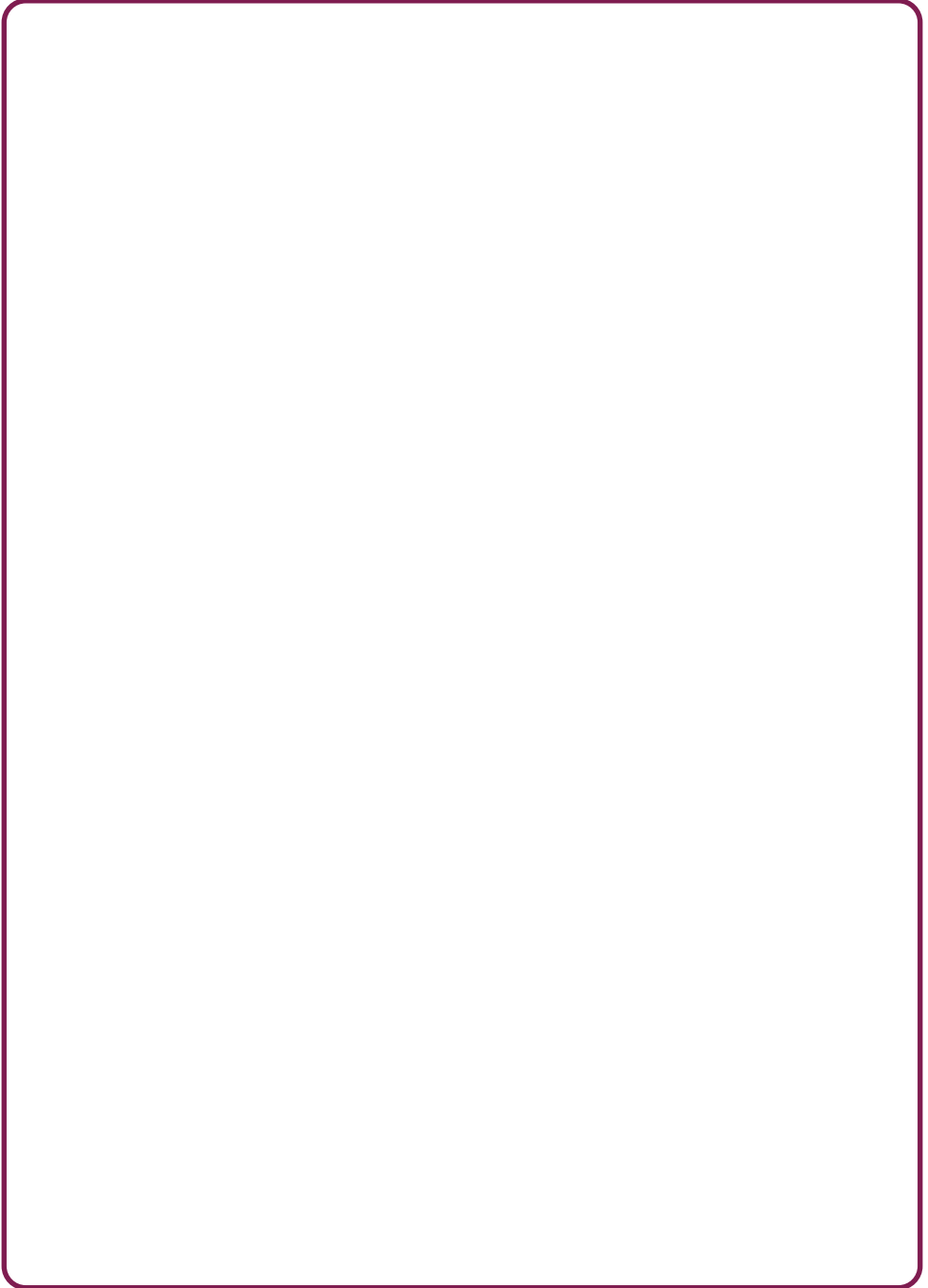

048-MS-12 series
048-MS-18 series
048-MS-24 series
048-MS-36 series

DELLA



Operations Manual

Learn how to use and maintain this appliance
and troubleshoot.

Warning and Safety

*Read this guide before installation. Failure to follow the safety instructions may result in property damage, serious injury or death.

DANGER

Indicates an **imminently** hazardous situation that, if not avoided, will result in death, serious injury, or serious property damage.

WARNING

Indicates a **potentially** hazardous situation that, if not avoided, will result in death, serious injury, or serious property damage.

CAUTION

Indicates a **potentially** hazardous situation that, if not avoided, will result in minor to moderate injury. It may also be used to indicate unsafe practice.

DANGER

- In the case of the appliance emitting smoke or burning smell, shut down the appliance and disconnect from the power supply immediately.
- In the case of refrigerant leakage, shut down the appliance and disconnect from the power supply. Contact a qualified technician for inspection. Refrigerant can be toxic and flammable. Rapid evaporation of refrigerant may cause frostbite, cardiac arrhythmia, and/or skin irritation.

WARNING

- Cleaning and maintenance should be carried out by a specialized technician. The appliance must be off and disconnected from the power supply before carrying out any maintenance.
- Do not disconnect the appliance from the power supply before shutting off the appliance. This might create a spark and potentially cause a fire.
- Repairs should be carried out by a professional or qualified technician only. Incorrect repair could expose the user to potential electric shock or other kinds of hazards.
- Do not place flammable substances such as alcohol, etc. Or of pressurized containers such as spray cans, or any other heat source near the appliance.
- Do not climb onto or place any objects on the appliance.
- Do not insert any objects into the appliance to prevent damage or injury.

Warning and Safety

CAUTION

- If the appliance is used in areas without the possibility of ventilation, precautions must be taken to prevent any leaks of refrigerant.
- Only use the appliance as instructed in this booklet. These instructions are not intended to cover every possible condition and situation. As with any electrical household appliance, common sense and caution are therefore always recommended for usage and maintenance.
- This appliance is designed and made for air conditioning in domestic environments only. It must not be used for any other purpose such as drying clothes or cooling foods.
- This appliance can be used by children 8 years old and above and persons with reduced physical, sensory, or mental capabilities, or lack of experience and knowledge if they have been given supervision or instruction concerning the use of the appliance in a safe way and understand the hazard involved.
- Children shall not play with the appliance.
- Always use the appliance with an air filter. Using the appliance without an air filter would lead to dust or waste accumulation or inner parts failure.
- Emptied remote control batteries must be recycled or disposed of properly.
- Do not touch the appliance when barefoot or parts of the body are wet or damp.
- Do not obstruct the air inlet or outlet.

Product Specification

Model	Indoor Unit		
	Net Weight	Noise Level	Net Dimension
048-MS-12K1V-17S-FZ	10kg / 22lb	42dBA	33" x 11.65" x 8" / 837 x 296 x 205 (mm)
048-MS-12K1V-17S-JA/JP	9.5kg / 20.9lb	42dBA	34.69" x 11.57" x 7.64" / 881 x 294 x 194 (mm)
048-MS-12K2V-17S-FZ	8.5kg / 18.7lb	42dBA	29.53" x 11.22" x 7.87" / 750 x 285 x 200 (mm)
048-MS-12K2V-17S-JA/JP	8.5kg / 18.7lb	42dBA	31.18" x 11.5" x 7.91" / 792 x 292 x 201 (mm)
048-MS-12K2V-21S-HA/HE	10kg / 22lb	43dBA	34.5" x 11.73" x 7.64" / 876 x 298 x 194 (mm)
048-MS-18K2V-17S-JA/JP	12kg / 26.4lb	46dBA	37" x 12.44" x 8.82" / 940 x 316 x 224 (mm)
048-MS-18K2V-17S-FZ	12kg / 26.4lb	45dBA	35.43" x 12.2" x 8.86" / 900 x 310 x 225 (mm)
048-MS-18K2V-21S-HA/HE	12kg / 26.4lb	49dBA	38.82" x 12.4" x 8.86" / 986 x 315 x 225 (mm)
048-MS-24K2V-17S-JA/JP	13kg / 28.6lb	54dBA	44.57" x 13" x 13" / 1132 x 330 x 332 (mm)
048-MS-24K2V-17S-FZ	14kg / 30.8lb	54dBA	42.6" x 13" x 9.17" / 1082 x 330 x 233 (mm)
048-MS-24K2V-21S-HA/HE	14kg / 30.8lb	50dBA	44" x 13" x 9" / 1121 x 329 x 231 (mm)

Product Specification

Outdoor Unit			Refrigerant
Net Weight	Noise Level	Net Dimension	
26kg / 57.3lb	51dBA	28.74" x 21.5" x 11.22" / 730 x 545 x 285 (mm)	R410A
26kg / 57.3lb	51dBA	28.74" x 21.5" x 11.22" / 730 x 545 x 285 (mm)	R410A
23kg / 50.7lb	53dBA	27.76" x 10.98" x 20.87" / 705 x 279 x 530 (mm)	R410A
23kg / 50.7lb	53dBA	27.76" x 10.98" x 20.87" / 705 x 279 x 530 (mm)	R410A
29kg / 63.9lb	51dBA	28.74" x 21.5" x 11.22" / 730 x 545 x 285 (mm)	R410A
27kg / 59.5lb	55dBA	28.74" x 21.5" x 11.22" / 730 x 545 x 285 (mm)	R410A
27kg / 59.5lb	53dBA	31.5" x 21.5" x 12.4" / 800 x 545 x 315 (mm)	R410A
49kg / 107.9lb	57dBA	35.43" x 27.56" x 13.78" / 900 x 700 x 350 (mm)	R410A
42.5kg / 93.6lb	60dBA	32.5" x 25.8" x 12.2" / 825 x 655 x 310 (mm)	R410A
42.5kg / 93.6lb	60dBA	32.5" x 25.8" x 12.2" / 825 x 655 x 310 (mm)	R410A
49.5kg / 109lb	59dBA	35.43" x 27.56" x 13.78" / 900 x 700 x 350 (mm)	R410A

Product Specification

Model	Rated Capacity		
	Cooling (Btu/h)	Heating (Btu/h)	Dehumidifying (kg/h)
048-MS-12K1V-17S-FZ	12000	12300	1
048-MS-12K1V-17S-JA/JP	12000	12300	1
048-MS-12K2V-17S-FZ	12000	12000	1
048-MS-12K2V-17S-JA/JP	12000	12000	1
048-MS-12K2V-21S-HA/HE	12000	12300	1
048-MS-18K2V-17S-JA/JP	18000	18400	1.6
048-MS-18K2V-17S-FZ	18000	18400	1.6
048-MS-18K2V-21S-HA/HE	17000	17000	1.6
048-MS-24K2V-17S-JA/JP	23000	24000	3
048-MS-24K2V-17S-FZ	23000	24000	3
048-MS-24K2V-21S-HA/HE	22000	23000	3

Product Specification

Rated Power Consumption		Rated Current		Power Supply
Cooling	Heating	Cooling	Heating	
1150W	1050W	14A	12A	115V / 60Hz / 1PH
1200W	1100W	14A	12A	115V / 60Hz / 1PH
1250W	1050W	5.6A	4.6A	208V - 230V / 60Hz / 1PH
1250W	1050W	5.6A	4.6A	208V - 230V / 60Hz / 1PH
1000W	970W	4.44A	4.3A	208V - 230V / 60Hz / 1PH
1850W	1700W	8A	7.5A	208V - 230V / 60Hz / 1PH
1840W	1650W	8A	7.5A	208V - 230V / 60Hz / 1PH
1400W	1350W	6.2A	6A	208V - 230V / 60Hz / 1PH
2400W	2200W	10.2A	10A	208V - 230V / 60Hz / 1PH
2400W	2200W	10.2A	10A	208V - 230V / 60Hz / 1PH
1950W	2050W	11A	11.5A	208V - 230V / 60Hz / 1PH

Parts Details

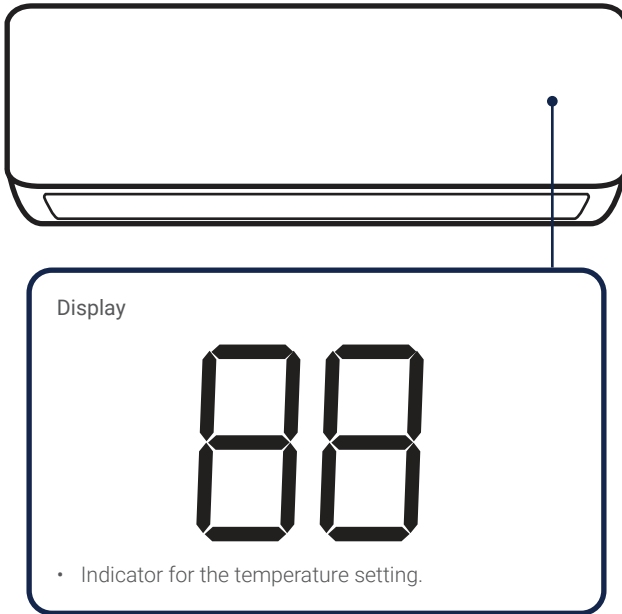
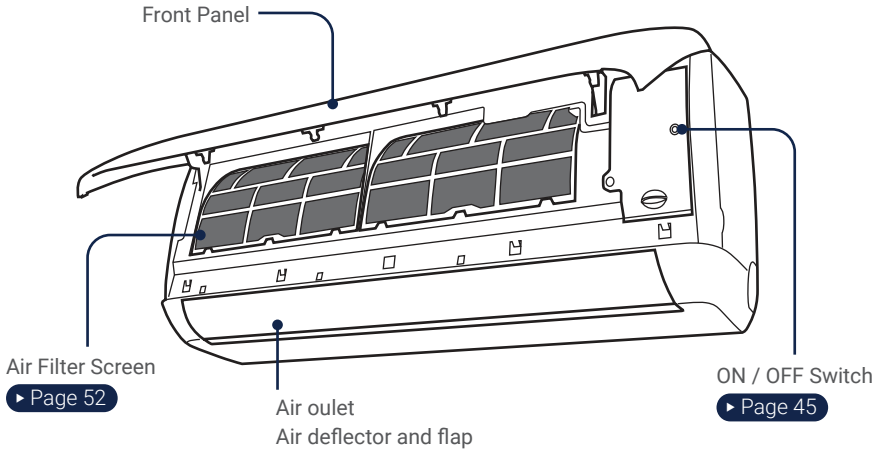

NOTE:

- The graphical representation might have slight differences than the actual product.

Remote Control

Front of Remote Control

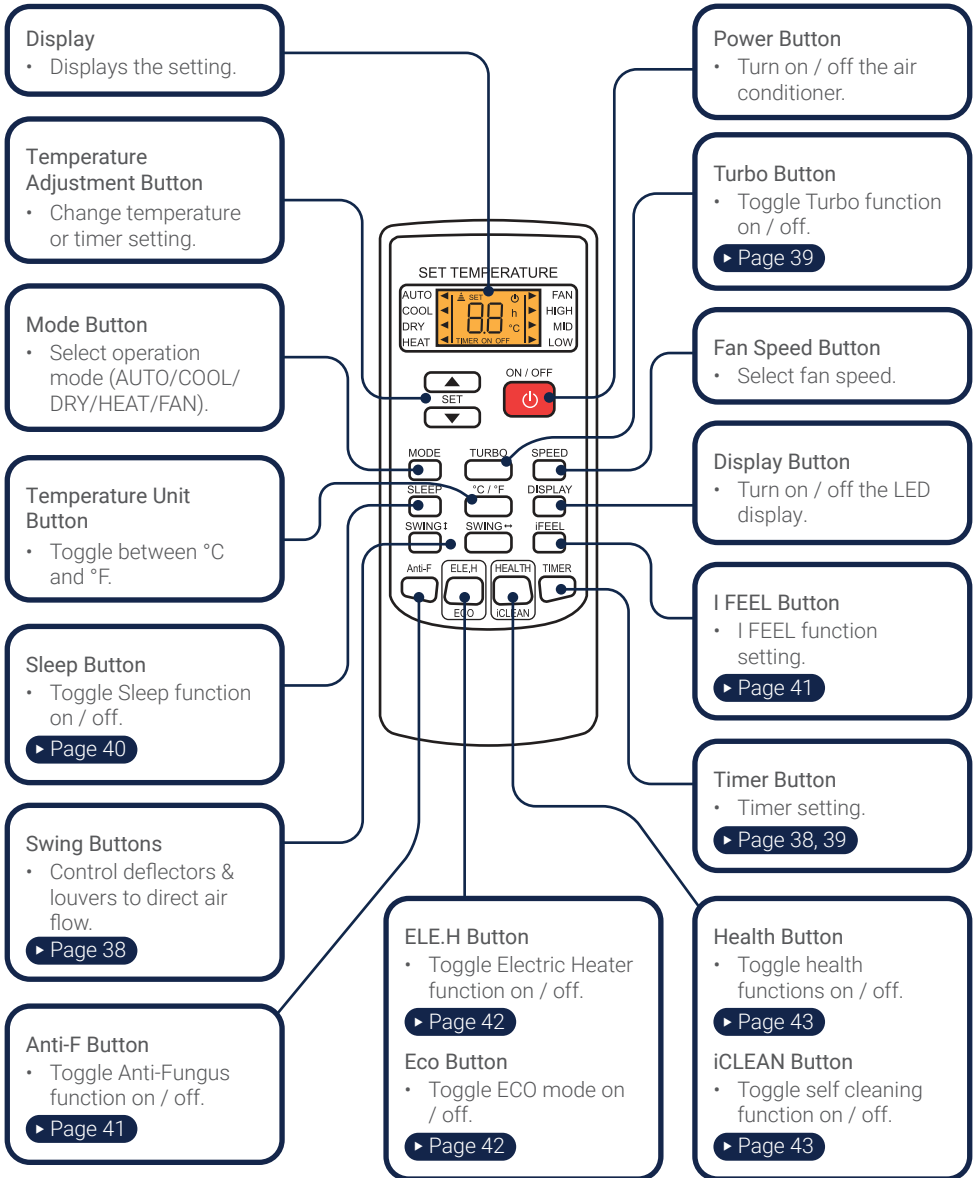

NOTE:

- Appearance of the display and function of the remote control might differ from some models.
- The shape and position of buttons and indicator of the remote control might differ from some models.
- Some models may not have all the functions listed above.

Remote Control

Remote Control Display

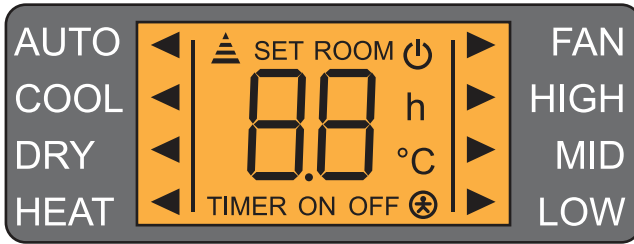

The remote control display shows your mode settings.

The backlight will turn on by pressing any button on the remote control and automatically turn off 10 seconds after the last input.

Back of Remote Control

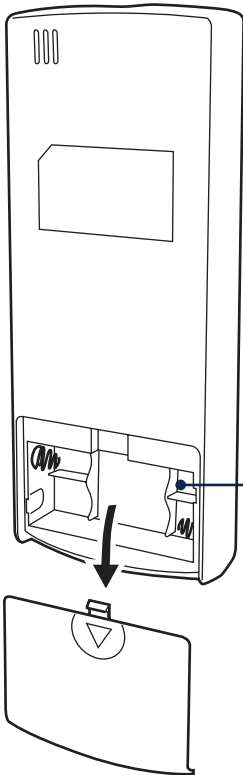

To set or replace batteries.

1. Remove the back cover from the remote control.
2. Insert 2 AAA 1.5V batteries.
3. Reinstall the back cover.

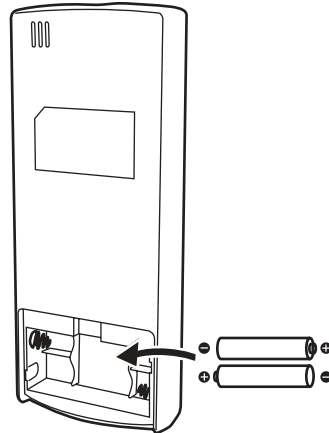

⚠ Attention

- Do not use rechargeable batteries.
- Replace the old batteries with new ones of the same type. Do not mix old and new batteries.
- Do not dispose batteries as unsorted municipal waste.

Operation Instructions

Auto Mode

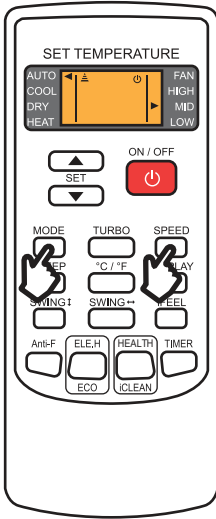

The auto function allows the air conditioner to automatically adjust the room's temperature according to the programmed auto mode temperature.

1. Press and select AUTO function.
- ◀ is pointed to AUTO on the display.



2. Press to change the air flow.



NOTE:

- Temperature setting is not available in AUTO mode.

Cool Mode

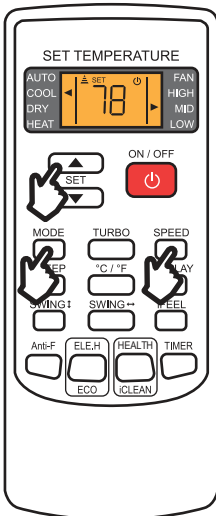

The cool function allows the air conditioner to cool the room and reduce humidity.

1. Press and select COOL function.
- ◀ is pointed to COOL on the display.



2. Press to set a temperature lower than the room temperature.

3. Press to change the air flow.





Operation Instructions

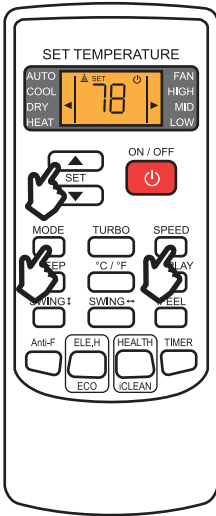

Dry Mode



Dry mode allows the air conditioner to reduce the humidity of the air and make the room more comfortable.

1. Press  and select DRY function.
-  is pointed to DRY on the display.





2. Press  to set a temperature lower than the room temperature.
3. Press  to change the air flow.



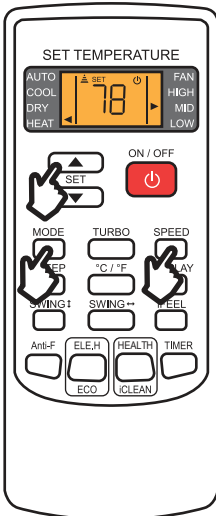

Heat Mode



The heat function allows the air conditioner to warm up the room.

1. Press  and select HEAT function.
-  is pointed to HEAT on the display.



2. Press  to set a temperature lower than the room temperature.
3. Press  to change the air flow.



NOTE:

- The outdoor unit may defrost for 5-12 minutes before blowing heated air in cold weather.

Operation Instructions

Fan Mode

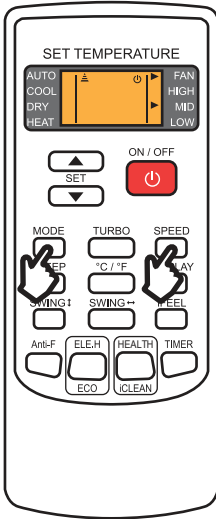

Fan function circulates and ventilates air in the room.

1. Press **MODE** and select FAN function.
- **▶** is pointed to FAN on the display.



2. Press **SPEED** to change the air flow.



Adjusting Air Flow

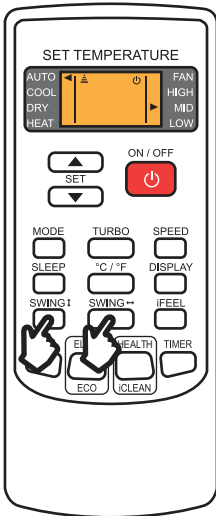

Adjusting up and down airflow

Adjust horizontal louvers.

1. Press **SWING↑** once to activate the horizontal louvers.
- Louvers will begin to swing.
2. Press **SWING↑** to set desired position.

Adjusting left and right airflow

Adjust vertical deflectors.

1. Press **SWING↔** once to activate the vertical deflectors.
- Deflectors will begin to swing.
2. Press **SWING↔** to set desired position.

NOTE:

- Never manually adjust the louvers or the deflectors. Attempt to move it by hand may damage the moving mechanism.

Operation Instructions

Timer

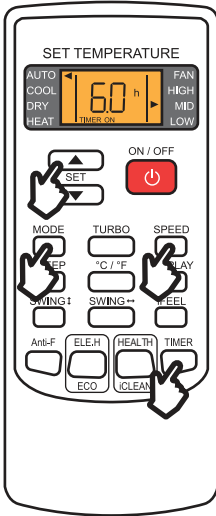

Setting ON Timer

Set a timer to automatically switch ON the air conditioner.

1. Turn off the unit.

2. Press  once to set switch on timer.

- 0.5 h and **TIMER ON** are displayed on the remote display and the "on" indicator flashes.

3. Press  to set desired switch on time.

- The timer increases by half an hour between 0 - 10 hours and one hour between 10 - 24 hours.

4. Press  again to confirm the timer setting.

5. After setting the ON timer, press  and  to set desired mode and fan speed.

6. Press  to set desired operation temperature.

NOTE:

- While ON timer is set, SLEEP, DISPLAY, and iFEEL buttons are not functional.

Cancel ON Timer

1. Press  again cancel the ON timer.

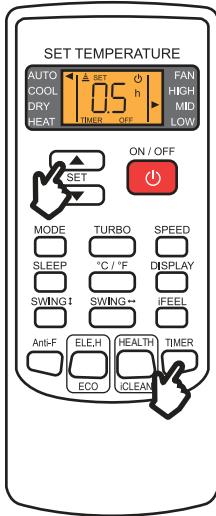

Operation Instructions

Timer



Setting OFF Timer

Set a timer to automatically switch OFF the air conditioner.

1. Press  once to set switch off timer.
 - 05 h and **TIMER OFF** are displayed on the remote display and the "off" indicator flashes.
2. Press  to set desired switch off time.
 - The timer increases by half an hour between 0 - 10 hours and one hour between 10 - 24 hours.
3. Press  again to confirm the timer setting.



Cancel OFF Timer

1. Press  again cancel the OFF timer.

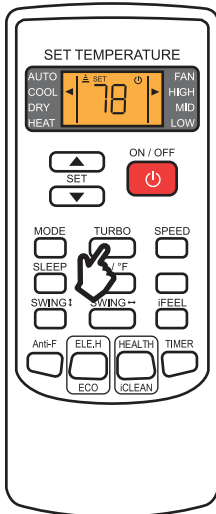
Turbo Function



Turbo function will speed up cooling or heating and blow the maximum flow of air.

1. Press  to activate turbo function.
 - The fan speed will automatically change to HIGH.
2. Press  again to deactivate turbo function.

Operation Instructions

Display Function

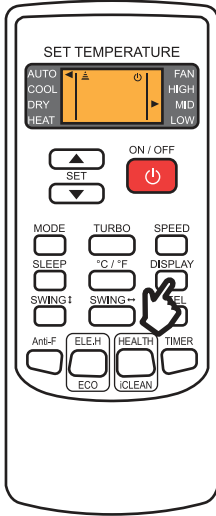

Switch ON / OFF the LED display on the indoor unit front panel.

1. Press **DISPLAY** once to turn off the indoor unit display.
2. Press **DISPLAY** again to turn on the display.

Sleep Function

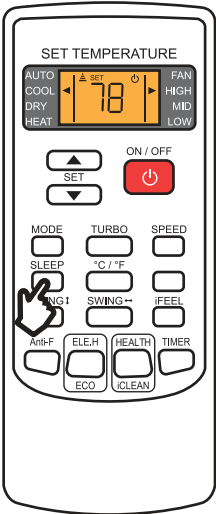

Sleep function is a pre-set automatic operating program which is suitable during sleep time.

1. Press **SLEEP** once to activate SLEEP function.
- The air conditioner will operate under sleep function for 10 hours before changing back to the previous setting mode.
2. Press **SLEEP** again to disable sleep function.

NOTE:



- Sleep function is not available when the unit is operating in FAN mode.

Operation Instructions

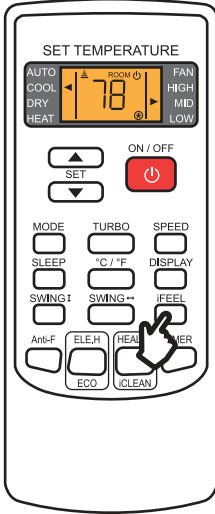
I FEEL Function



I FEEL function turns your remote control into a portable thermostat that automatically controls the unit to adjust the temperature of the room you are in.

1. Press  once to activate I FEEL function.
 - ROOM and  are displayed on the display.
2. Press  again to disable I FEEL function.

Anti-F Function

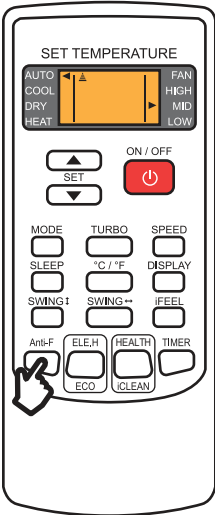

Anti-F function will dry the internals of the indoor unit after you turn off the air conditioner to prevent the growth of fungus or mold.

Enable Anti-F Function

1. When the unit is off, press  once to enable Anti-F function.
 - The indoor unit beeps 5 times and the remote control display flashes 5 times indicating the Anti-F function is enabled.
2. The next time you turn off the air conditioner after using, the unit will automatically operate in HEAT mode and low fan speed (FAN mode for COOL only models) for about 3 minutes before fully turning off.

NOTE:

- When Anti-F function is operating, do not turn on the unit before it has completely turned off.
- Anti-F function is not functional when OFF timer is set.

Disable Anti-F Function



1. When the unit is off, press  once to disable Anti-F function.
 - The indoor unit beeps 3 times and the remote control display flashes 5 times indicating the Anti-F function is disabled.

Operation Instructions

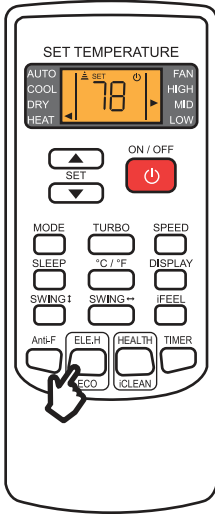
ELE.H Function



Switch ON / OFF electric heating on the unit.

1. When the unit is operating in HEAT mode, press  once to turn on electric heating.
2. Press  again to disable ECO function.

NOTE:

- This function is not available to North America models.

Eco Mode

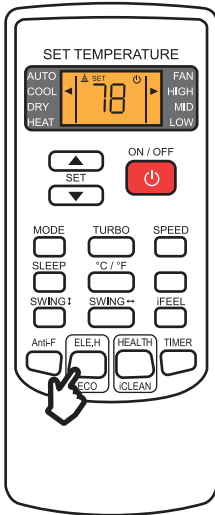

The air conditioner will operate in the lowest electric consumption for a period of time.

1. When the unit is operating in COOL mode, press  once to turn on eco mode.
2. The air conditioner will operate in Eco mode for 8 hours and then goes back to normal mode.

NOTE:



- Changing operation mode or turning off the air conditioner will automatically cancels ECO mode.
- The ECO mode only works for inverter models.

Operation Instructions

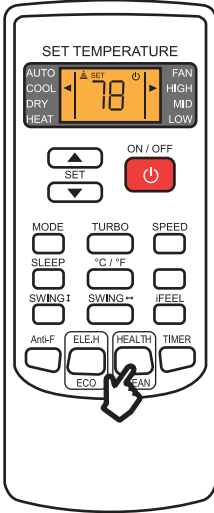
Health Function





Switch ON / OFF health related function on the unit.

1. When the unit is on, press  once to turn on health function.
- Health related function such as negative ion, electrostatic precipitation, PM2.5 removal, etc, will be on depending on your actual model.
2. Press  again to disable health function.

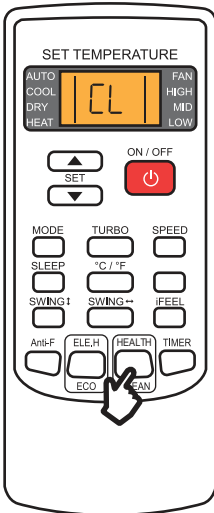
iCLEAN Function



Switch ON / OFF the unit self cleaning function.

1. When the unit is off, press  once to turn on eco mode.
- The unit display and remote control will display  and automatically clean dust off the evaporator and dry it.

Operation Instructions

Ambient Temperature

Your air conditioner may stop operating in the following temperature conditions.

	COOL Mode	HEAT Mode
Ambient Room Temperature	< 64.4°F / 18°C	> 80.6°F / 27°C
Outdoor Temperature	T1 Climate: > 109.4°F / 43°C	< 19.4°F / -7°C or > 75.2°F / 24°C
	T3 Climate: > 125.6°F / 52°C	

NOTE:

- Attempting to use the air conditioner beyond the specified temperature range may activate the protection device and cause the air conditioner to stop operating.
- When the temperature is too low, the heat exchanger of the air conditioner may freeze, leading to water leakage or other malfunction.
- Prolong cooling or dehumidification in a humid environment may lead to water condensation or dripping near the air outlet.
- T1 and T3 refer to ISO 5151.

Operating Temperature

You can set the air conditioner temperature within the following range.

	Operation Temperature Setting
Remote Control YKR-H/101E YKR-H/102E	60°F - 90°F / 16°C - 32°C
Remote Control YKR-H/132E	68°F - 82°F / 20°C - 28°C

NOTE:

- Avoid prolonged exposure to cold air, especially to children, elderly, or medical patients.

Operation Instructions

Emergency Button

You can use the emergency button for limited control of the air conditioner in case the remote control fails or is missing.

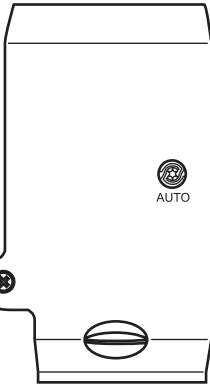
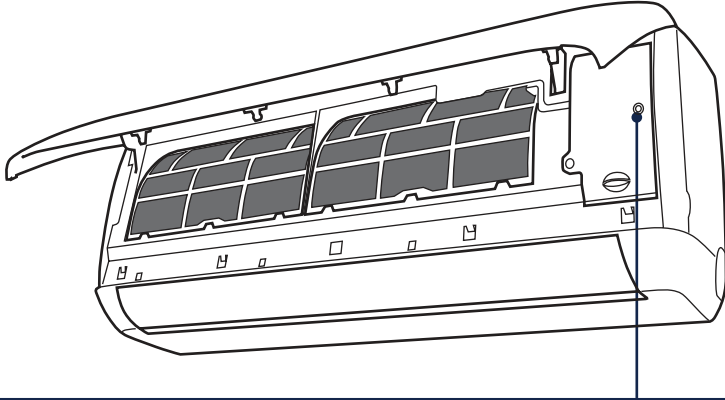

Indoor unit ON/OFF switch

- In stand by mode, press this switch ONCE to start AUTO mode.
- In operation, press this switch ONCE to turn off the unit.

NOTE:

- Always wear insulation material when pressing the emergency button.

Wi-fi / App Connection

Wi-Fi Network



- Make sure you have a working Wi-Fi network.
- Connect your smart-phone to the Wi-Fi network.
- Wi-Fi network must support 2.4GHz, the appliance cannot connect to a 5GHz network.

Wi-Fi Requirement	
Standards of WLAN	IEEE 801.11 b/g/n(channels 1-14)
Protocal Stack Support	IPv4 / IPv6 / TCP / UDP / HTTPS / TLS / MulticaseDNS
Security Support	WEP / WPA / WPA2 / AES128
Network Type Support	STA / AP / STA+AP

Download the Application



- Search "DELLA+" on app store or google play, or scan the QR code below to download the application.
- Enable permission of storage, location, and camera for this application, otherwise it will have a problem operating.



NOTE:

- The Della+ application is free; however, data charges may apply when downloading or using the application.
- Every effort has been made to ensure the accuracy of the instruction and graphic representations at the time of producing this user guide. Your application's user interface, icons, and screen may look different from this guide due to updates and development changes.
- Della+ app can be altered without notice for quality improvement and also be deleted depending on the circumstances of manufacturing firms.

Wi-fi / App Connection

User Registration



1 Open the DELLA+ app on your smart devices.

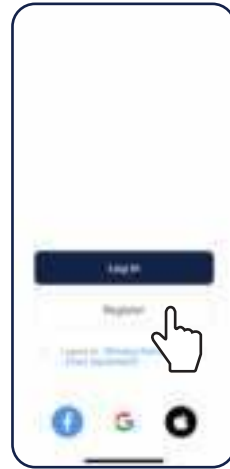

2 Tap the "Register" button for first time user.



3 Tap the country menu.



4 Select your country.



5 Enter your email address, then read and agree to the user agreement, and get verification code.

Wi-fi / App Connection

User Registration



- 6 Enter the verification code.



- 7 Set your password and tap "Done".

Wi-fi / App Connection

Add Device



1 Tap "Add Device" in the center of the screen or the "+" dropdown menu from the top right corner.



2 Select the appliance type you want to add by scanning the QR above. You can also find the model series on the unit specification label or on the packaging.

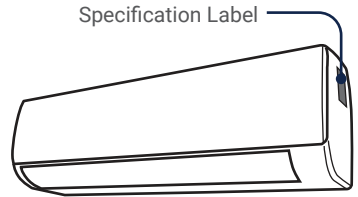

Model Series QR Code

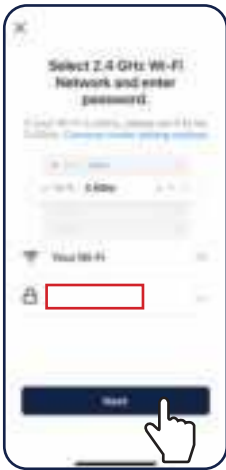

3 Enter your Wi-Fi network password, then tap "Next".

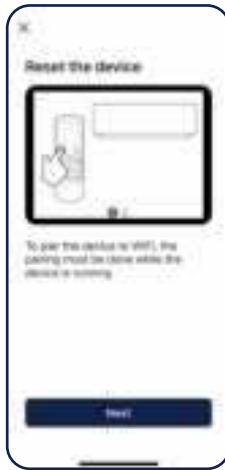

4 Follow the in-app instruction on adding the device.



3 You can see your device on the device list after adding.

Wi-fi / App Connection

Basic Control

The basic function of the application interface mimics to that of the remote control.

NOTE:

- Some functions may not be available on the application.



NOTE:

- Appearance of the display and function of the application might differ.
- The shape and position of buttons and indicator of the user interface might differ.

Wi-fi / App Connection

Scene



- 1 Tap "Create Scene" in the center of the screen or the "+" dropdown menu from the top right corner.

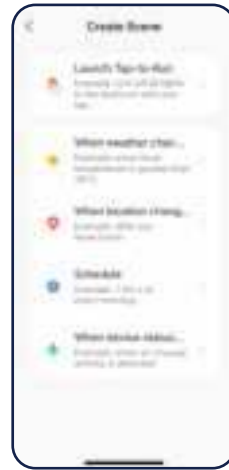

- 2 Customize your unique user experience.

"Scene" function allows you to program your air conditioner to turn on / off depending on your location, and set automated features.

Care and Maintenance

⚠ CAUTION

- Before cleaning the unit, you must shut down the machine and cut off the power supply for at least 5 minutes.
- Never flush the air conditioner with water.

Clean the Unit

1. Clean the air conditioner with a soft dry cloth or a dampened cloth with neutral detergent.

NOTE:

- Do not flush the machine with water.
- Do not use volatile liquid such as thinner or alcohol to prevent damaging the unit.



Clean the Air Filter

1. Open the front panel.
2. Pull down the air filter.
3. Clean the air filter with soapy water.
4. Air dry the air filter
5. Put the air filter back to its original place after it is dry.

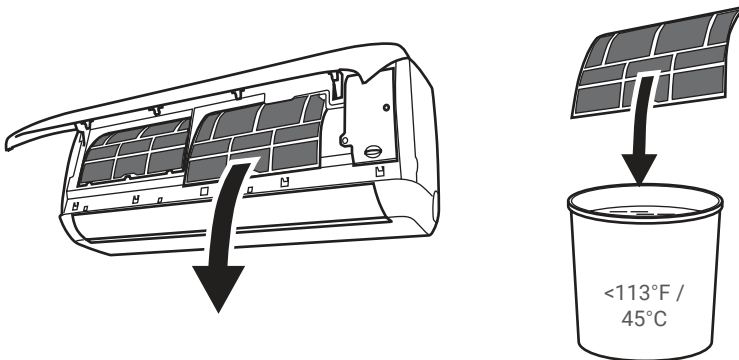

NOTE:

- Do not touch the fins inside the indoor unit with bare hands after removing the filter screen.
- Check and clean the air filter regularly to prevent dust accumulation.
- Clean the air filter frequently if the operating environment is dusty or has bad air quality.

Care and Maintenance

Maintenance Routine

- Clean the air filter screen every 3 months.
- Call your HVAC technician to check on the refrigerant level every 3 to 4 years.
- Regularly check and remove any obstacles at the outdoor unit.

Planning to not operate the air conditioner for a long period

1. Take out the batteries from the remote control and disconnect the power supply of the air conditioner.

When Using the Air Conditioner After a Long Idle Period

1. Clean the unit and the air filter screen.
2. Remove any obstacles at the air inlet and outlet of both the indoor and outdoor unit.
3. Make sure the drain pipe is unobstructed.
4. Install batteries into the remote control and connect the power supply to the air conditioner.

Troubleshooting

Problem	Possible Causes
The appliance is non operational	Power failure / plug pulled out
	Damaged indoor or outdoor unit fan motor
	Faulty compressor thermomagnetic circuit breaker
	Faulty protective device or fuses
	Loose Connection
	Internal protection tripped
	Outlet voltage does not match to that of the appliance
	The unit is currently in ON-TIMER mode
	Damaged electronic control board
Strange Odor	Dirty air filter
Noise of running water	Backflow of liquid in the refrigerant circulation
A fine mist comes from the air outlet	This occurs when the air in the room becomes cold in COOL or DRY modes
Strange noise	The noise made by thermal expansion of the front panel due to temperature is normal and does not indicate a problem
Insufficient airflow, either hot or cold	Unsuitable temperature setting
	Obstructed air conditioner intakes and outlets
	Dirty air filter
	Fan speed is set at minimum
	Other sources of heat in the room
The appliance does not respond to commands	Insufficient refrigerant levels
	Remote Control is too far away from the indoor unit
	The batteries of the remote control need to be replaced
	Obstacles between the indoor unit and the remote control

Troubleshooting

Problem	Possible Causes
The display is off	DISPLAY toggle is set to off
	Power failure
Indoor unit does not operate immediately after a restart	Protective delay switch will delay the operation for 3 - 5 minutes if the air conditioner is turned on immediately after it is turned off

Switch off the air conditioner immediately and cut off the power supply in the event of:

- Strange noises during operation.
- Faulty electronic control board.
- Faulty fuses or switches.
- Spraying water or objects inside the appliance.
- Overheated cables or plugs.
- Very strong smells coming from the appliance.

CAUTION

- Contact a professional HVAC technician for further assistance. Incorrect repairs may cause electric shock, fire, or permanent damage to the unit.

Troubleshooting

Error Codes

In case of an error, the indoor unit display will show the following error codes:

Display	Description
E0	Indoor Unit Overcurrent Protection
E1	Indoor Unit Temperature Sensor Error
E2	Outdoor Unit Coil Sensor Error
E3	Indoor Unit Coil Sensor Error
E4	Indoor Unit Fan Error
E5 (5E)	Indoor and Outdoor Unit Communication Error
E8	Display Board and Main Control Panel Communication Error
F0	Outdoor Unit Fan Error
F1	Module Protection Error
F2	Power Factor Correction (PFC) board Error
F3	Compressor Out of Step Error
F4	Exhaust Sensor Error
F5	Compressor Top Head Sensor Error
F6	Outdoor Unit Temperature Sensor Error
F7	Overvoltage Protection (OVP) or Undervoltage Protection (UVP) Error
F8	Outdoor Unit Control Panel and Module Panel Communication Error
F9	Outdoor EEPROM Error

Troubleshooting

Display	Description
FA	Recirculated Sensor Error
P2	High Voltage Switch Protection
P3	Refrigerant Deficiency Protection
P4	Refrigerant Overload Protection
P5	Exhaust Protection
P6	Indoor Unit High Temperature Protection
P7	Anti-Freezing Protection
P8	Overcurrent Protection

Disposal Guideline

This appliance contains refrigerant and other potentially hazardous materials. When disposing of the appliance, follow all federal, state, and local regulations. **DO NOT** dispose of this product as normal household waste or unsorted municipal waste.

When disposing of this appliance, you have the following options:

- Dispose of this appliance at a designated municipal electronic waste collection facility.
- When buying a new appliance, the retailer will take the old appliance.
- The manufacturer may take back the old appliance.
- Sell the appliance to a certified scrap metal dealer.

Memo

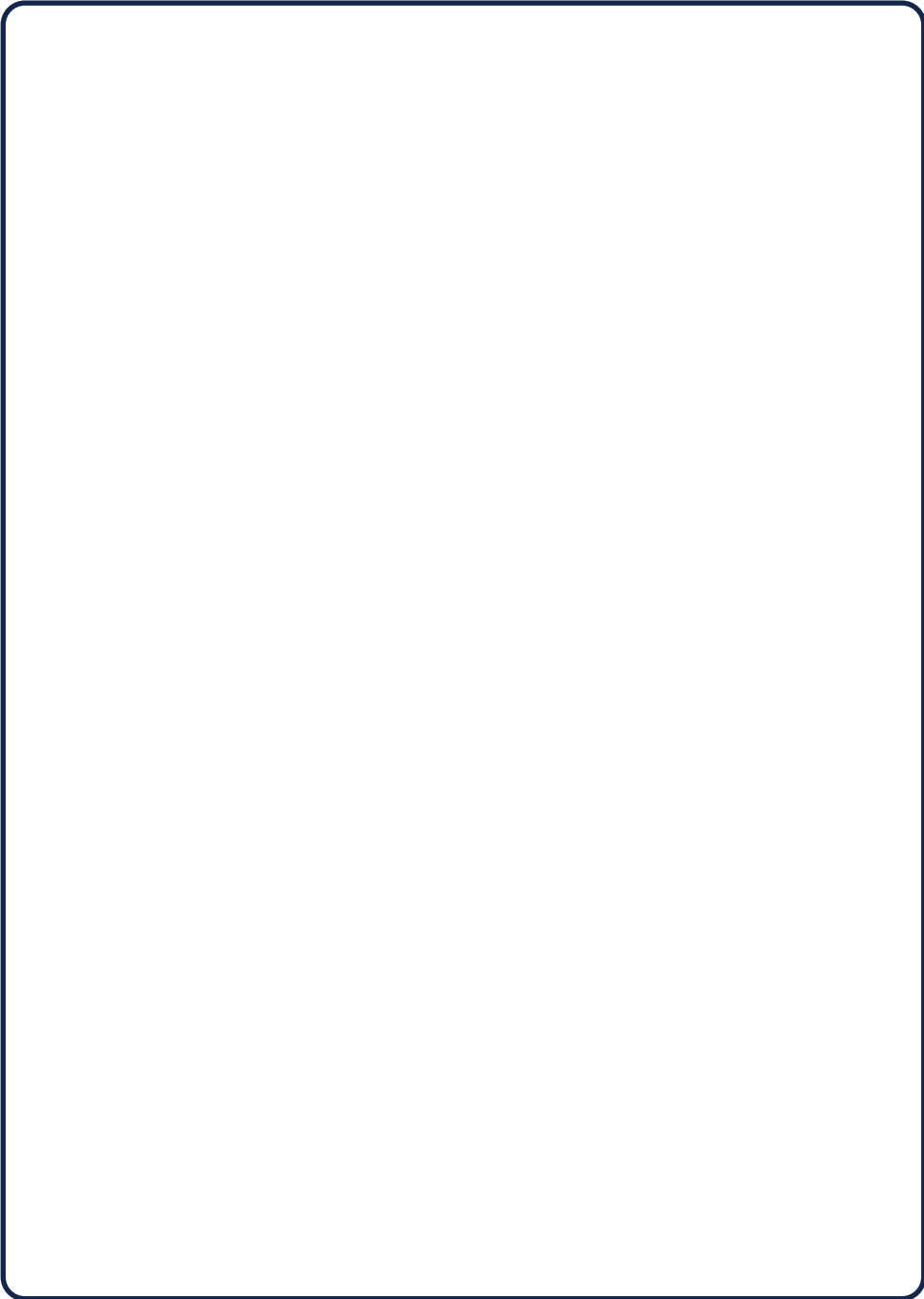



www.dellahome.com
manufacturer@dellahome.com
800-863-4143
6:00a.m. – 4:00p.m. PST Monday - Friday

©Della All rights reserved.

Under the copyright law, this document may not be printed, translated, reproduced, or distribute, in whole or in part without written permission from DELLA.

Every effort has been made to ensure that the information in this document is accurate, DELLA is not responsible for printing or clerical errors.

All trademarks, logo, brand names are the property of their respective companies. Mention of third-party products or service names are for identification and informational purposes only. Use of these names, brands, and trademarks does not imply endorsement. DELLA assumes no responsibility with regard to the performance or use of these products.