

# Clarke®



## 1.2KW DEVIL QUARTZ HALOGEN HEATER MODEL NO: DEVIL 1200Q

PART NO: 6920333

## OPERATING & MAINTENANCE INSTRUCTIONS

UK  
CA | CE



ORIGINAL INSTRUCTIONS

DL0725 Rev 2

---

## INTRODUCTION

---

Thank you for purchasing this CLARKE Quartz Halogen Heater.

Before attempting to use this product, please read this manual thoroughly and follow the instructions carefully. In doing so you will ensure the safety of yourself and that of others around you, and you can look forward to your purchase giving you long and satisfactory service.

## GUARANTEE

This product is guaranteed against faulty manufacture for a period of 12 months from the date of purchase. Please keep your receipt which will be required as proof of purchase. This guarantee is invalid if the product is found to have been abused or tampered with in any way, or not used for the purpose for which it was intended.

Faulty goods should be returned to their place of purchase, no product can be returned to us without prior permission.

This guarantee does not effect your statutory rights.

---

## SPECIFICATIONS

---

<b>Model Number</b>	<b>Devil 1200Q</b>
Part Number	6920333
Weight	2.7kg
Dimensions (W x D x H)	412 x 95 x 210mm
Rated Input Wattage	1.2kW
Rated Input Current	5.2A
Supply Voltage	230V/50Hz
Plug Fuse Rating	13A
Ingress Protection Class	IP20
Duty Cycle	S1 - Continuous
Minimum Mounting Height	1.8m

## THE FOLLOWING TABLE ADDRESSES THE INFORMATION REQUIREMENTS OF REG.2024/ 1103

Item	Symbol	Value	Unit
<b>Heat output</b>			
Nominal heat output	$P_{nom}$	1.2	kW
Minimum heat output (indicative)	$P_{min}$	N/A	kW
Maximum continuous heat output	$P_{max, c}$	N/A	kW
<b>Auxiliary electricity consumption</b>			
In off mode	$P_o$	0.000	W
In standby mode	$P_{sm}$	0.000	W
In idle mode	$P_{idle}$	N/A	W
In network standby	$P_{nsm}$	N/A	W
Seasonal space heating energy efficiency in active mode	$\eta_{s, on}$	80	%
Standby mode with display information or status	-	No	-
<b>Type of heat output/room temperature control (select one)</b>			
Single stage heat output, no temperature control			No
Two or more manual stages, no temperature control			Yes
With mechanical thermostat temp control			No
With electronic temperature control			No
Electronic temperature control with day timer			No
Electronic temperature control with week timer			No
<b>Other control options (multiple selections possible)</b>			
Room temperature control with presence detection			No
Room temperature control with open window detection			No
Room temperature control with distance control option			No
Room temperature control with adaptive start control			No
Room temperature control with working time limitation			No
Room temperature control with black bulb sensor			No
Room temperature control with self-learning functionality			No
Room temperature control with control accuracy			No

---

# SAFETY RULES

---

Make sure that you read, understand and comply with the following.



**WARNING: THIS PRODUCT IS ONLY SUITABLE FOR WELL INSULATED AREAS AND IS NOT DESIGNED TO BE THE PRIMARY HEAT SOURCE.**

---

## SAFE WORKING PRACTICES

1. **DO NOT** operate the heater when you are tired or under the influence of alcohol, drugs or intoxicating medication.
2. **DO NOT** stand on the heater.
3. **DO NOT** use the heater with wet hands or when there is water on the power cable.
4. Turn the heater off when not in use and keep it in a safe, dry location.
5. The heater is designed to heat enclosed areas, such as workshops and other industrial areas. **DO NOT** use the heater for any other function. It is not suitable for drying clothes or laundry.

## ELECTRICAL SAFETY

1. Electrical appliances must match the power outlet. **NEVER** modify the plug in any way. **DO NOT** use adaptor plugs with earthed (grounded) appliances. Correct plugs and outlets will reduce the risk of electric shock.
2. **DO NOT** abuse the electrical cable. **NEVER** use the cable for pulling or unplugging the heater. Keep the cable away from sources of heat, oil, sharp edges or moving parts. Damaged or tangled cables increase the risk of electric shock.
3. Keep the power cable well away from machines and ensure an adequate electrical supply is close at hand so that the operation is not restricted by the length of the cable.
4. **ALWAYS** disconnect from the power supply before moving the heater or performing any cleaning or maintenance tasks.
5. Inspect the mains cable regularly for signs of damage. **DO NOT** use if it is damaged, and **ALWAYS** keep it away from the source of heat.
6. Check the heater for damage before use. **DO NOT** use if the heater tubes/elements are damaged or broken. Any damage should be properly repaired or the part replaced. If in doubt, **DO NOT** use. Consult your local CLARKE dealer.

## POSITIONING



**WARNING: DO NOT USE THE HEATER NEAR FLAMMABLE MATERIAL, LIQUIDS, SOLIDS, GASES OR COMPRESSED GAS CYLINDERS ETC.**

1. This heater is designed for indoor use only.
2. **DO NOT** use this heater in small rooms when they are occupied by persons not capable of leaving the room on their own unless constant supervision is provided.
3. **DO NOT** use this heater in the immediate surrounds of a bath, a shower, a swimming pool or wet surfaces.
4. **NEVER** place the heater against or near any surface such as a wall, door, curtains, furniture or combustible material etc. Allow at least 2 metre clearance.
5. **DO NOT** place the heater immediately below any electrical outlet.
6. **DO NOT** place the heater on a raised surface or anywhere where it could topple over. **ALWAYS** use on a horizontal and stable surface.
7. **ALWAYS** ensure that the grille cannot be blocked or covered.
8. **DO NOT** operate fan heaters in explosive atmospheres such as in the presence of flammable liquids, gasses or dust such as in a paint spray booth or any explosive environment. Electric motors create sparks which may ignite dust or fumes.
9. This heater can be used by children aged 8 and above and persons with reduced physical, sensory and mental capabilities or lack of knowledge if they have been given instruction concerning the use of appliance in a safe way and understand the hazards.
10. Children less than 3years should be kept away unless continuously supervised.
11. Children should **NOT** play with this appliance.

## OPERATION

1. **CAUTION:** Some parts of this product can become very hot and cause burns. Particular attention should be given where children, vulnerable people and animals are present.
2. The heater must only be used by people who have read these instructions and have been trained in its use.
3. **DO NOT** use if dropped.
4. **DO NOT** use if there is visible signs of damage.
5. **DO NOT** obstruct the air inlet and outlet sections of the heater.
6. **DO NOT** cover the heater with anything that could restrict the air flow.

7. **DO NOT** touch the heater casing or grille when first switched off, as these will be very hot and will take time to cool.
8. **DO NOT** get the heater wet or use in areas of high condensation.
9. **DO NOT** connect other appliances to the same mains socket as the heater.
10. **DO NOT** use this heater with a programmable timer used to switch it on automatically.
11. **DO NOT** leave the heater unattended.

## SAFETY SYMBOLS

These safety symbols appear on the heater.

	<p><b>CAUTION: Hot Surface, DO NOT Touch</b></p>	 <p><b>DO NOT COVER</b></p>	<p><b>DO NOT Cover</b></p>
-----------------------------------------------------------------------------------	------------------------------------------------------	--------------------------------------------------------------------------------------------------------------	----------------------------

## SERVICE & REPAIRS

- If necessary, have your heater repaired by a qualified person using identical replacement parts. This will ensure that the safety of the product is maintained.

Please keep these instructions in a safe place for future reference.

---

## CLARKE ACCESSORIES

---

This heater unit, as well as being wall mounted, can also be mounted on a free standing tripod. This tripod can be purchased from any CLARKE stockists.

- Model: Tripod for Devil 1200Q & Devil 2800Q Quartz Infrared Heaters, product number: 6920335



# ELECTRICAL CONNECTIONS



**WARNING: READ THESE ELECTRICAL SAFETY INSTRUCTIONS THOROUGHLY BEFORE CONNECTING THE PRODUCT TO THE POWER SUPPLY.**

The 230V models are provided with a 13 Amp BS 1363 plug, fitted with a 13 Amp fuse and **MUST** be connected to a standard, 230 Volt (50Hz) electrical supply, preferably through a suitably fused isolator switch.

If the plug has to be changed because it is not suitable for your socket or because of damage, it must be removed and a replacement fitted, following the wiring instructions shown below. The old plug must be discarded safely as insertion into a power socket could cause an electrical hazard.

The wires in the mains lead should be wired up in accordance with the following colour code:

- Connect the GREEN & YELLOW wire to the plug terminal marked with a letter E.
- Connect the BROWN wire to the plug terminal marked a letter "L".
- Connect the BLUE wire to the plug terminal marked a letter "N".

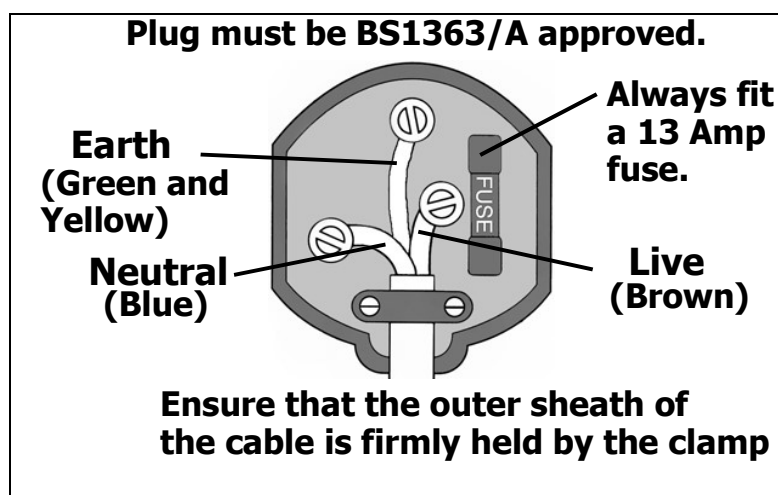

The fuse in the plug must be replaced with one of the same rating and this replacement must be ASTA approved to BS1362.

We strongly recommend that this machine is connected to the mains supply via a Residual Current Device (RCD).

If in any doubt, consult a qualified electrician. **DO NOT** attempt any electrical repairs yourself.

---

# UNPACKING AND ASSEMBLY

---

## UNPACKING

Before assembling, please check contents against the following list and advise your dealer immediately if any parts are missing.

1 x Heater

1 x 2 Piece Wall Support Bracket and 4 Screws

## WALL MOUNTING ASSEMBLY



**WARNING: LOCATE THE UNIT NO CLOSER THAN 0.3M TO THE CEILING, NO LESS THAN 1.8M FROM THE FLOOR AND NO LESS THAN 1M FROM ANY SIDEWALL. ENSURE THE MOUNTING SURFACE IS SUITABLE AND STRONG ENOUGH TO SECURELY AND SAFELY MOUNT THE UNIT (FIXINGS NOT SUPPLIED).**

1. Remove the four screws on the rear of the unit and take out the unit mounting bracket.

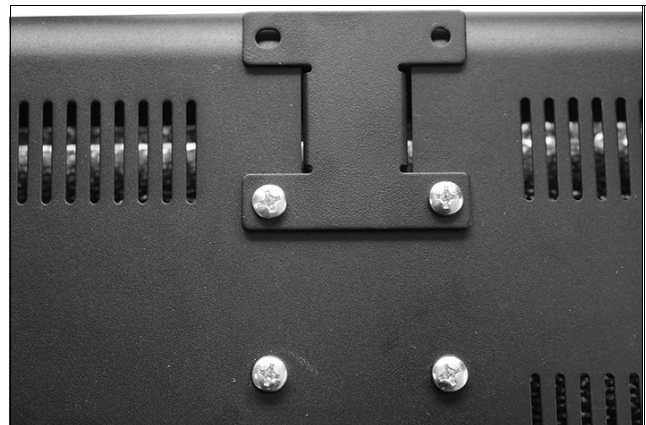

2. Use the 4 screws to attach the unit mounting bracket to the rear of the unit as shown.

**NOTE:** Make sure its orientation is correct in order to facilitate downward adjustment of the unit when fitted to the wall mounting bracket.

3. Ensure all fixings are firmly and securely attached.

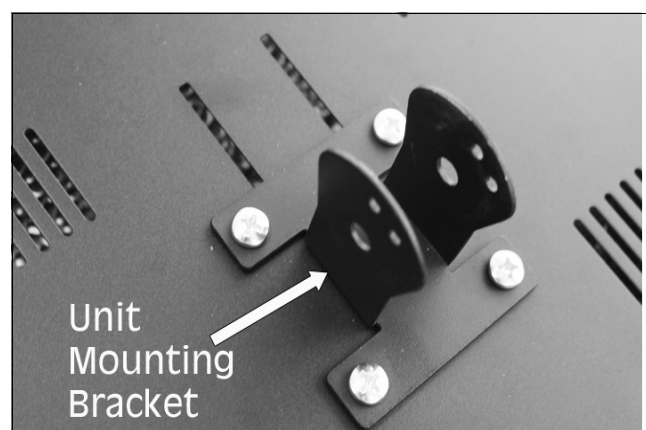

4. Mount the wall mounting bracket to a suitable wall via the 3 mounting holes as shown and suitable fixings (not supplied).

**NOTE:** No closer than 0.3m to the ceiling, 1.8m from the floor and 1m from any side walls.

Mounting Holes



5. Remove the large bolt and small screw from the wall mounting bracket. Slide the wall mounting bracket between the unit mounting bracket arms and secure with the large bolt. Adjust the unit so that the small screw holes (2 positions available) align and screw in the small screw to secure the unit at the angle required.

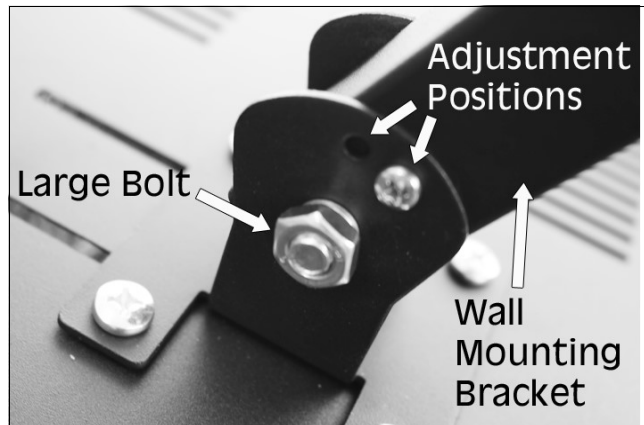

### IF USING THE TRIPOD (SOLD SEPARATELY)

1. Undertake points 1 - 3 of the Wall Mounting Assembly.
2. Pull out the locking pin and extend the legs as far as possible until the locking pin fits in the lower locking hole.

**NOTE: DO NOT** use if pin does not lock into place in the lower locking hole

Locking Pin



3. Using the large bolt that is supplied with the wall mounting bracket, attach the tripod mounting bracket to the unit mounting bracket as shown.



4. Place the tripod mounting bracket into the top of the tripod and tighten in place using the locking screw.



---

## OPERATION

---



**WARNING: FOR SAFE OPERATION OF THIS HEATER IT IS ESSENTIAL TO READ THESE INSTRUCTIONS BEFORE USE.**

---

## MANUAL OPERATION

1. Mount the heater on a wall or tripod and following all safety precautions and assembly instructions, connect to a suitable power supply.
2. Switch the power on or off using the primary ON/OFF rocker switch, as follows.
  - O = Off
  - I = Low Heat, 600W
  - II = High Heat, 1200W

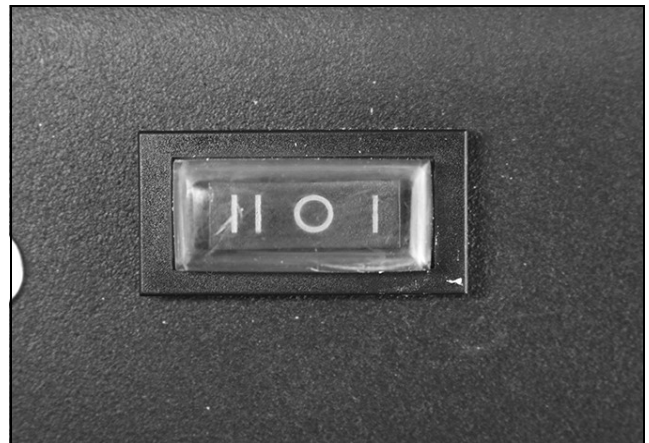

---

## CLEANING & MAINTENANCE

---

If the heater has been used, always allow it to cool down for at least 15 minutes and disconnect from the power supply before performing any maintenance tasks.

### FITTING/REPLACING TUBES

Before attempting to fit/replace halogen tubes, make sure that the heater is switched off and isolated from the electrical supply by removing the plug from the socket.

**NEVER** handle the halogen tubes with bare hands. Always handle using either a soft clean glove or a piece of soft clean cloth wrapped around the lamp.

1. Loosen and remove the retaining screws on the top and bottom of the unit securing the front cover, remove the guard and store removed parts safely.
2. To remove the tube, grasp and gently but firmly push it to one end of the heater. The tube holders are spring loaded and will allow the tube sufficient movement to clear the opposite holder.
3. Remove the tube and dispose of it according to local regulations.
4. Fit new halogen tube in reverse order.
5. Replace the guard and cover using the screws removed earlier.
6. Make sure all fixings are secure and tight.

The heater is now ready for use again.

### PERIODICALLY

1. If there is any serious build up of dirt, wipe the exterior thoroughly with a damp cloth. Take care that no moisture enters the heater. Take care **NOT** to touch the tubes with your fingers.
2. Inspect the power cable for damage. Undue heat will cause the cable to stiffen and crack. If this is found, have the cable replaced. Check cable routing and ensure it is well away from the heat source.
3. Ensure heating tube is clear of dust (use compressed air to clean if possible, **ALWAYS** wear a dust mask and safety glasses if performing this operation).
4. Refer to your CLARKE dealer if internal repair is required.
5. When storing the heater, allow it to cool down, then place it in its packing box for storage in a dry, ventilated place.

# PARTS DIAGRAM

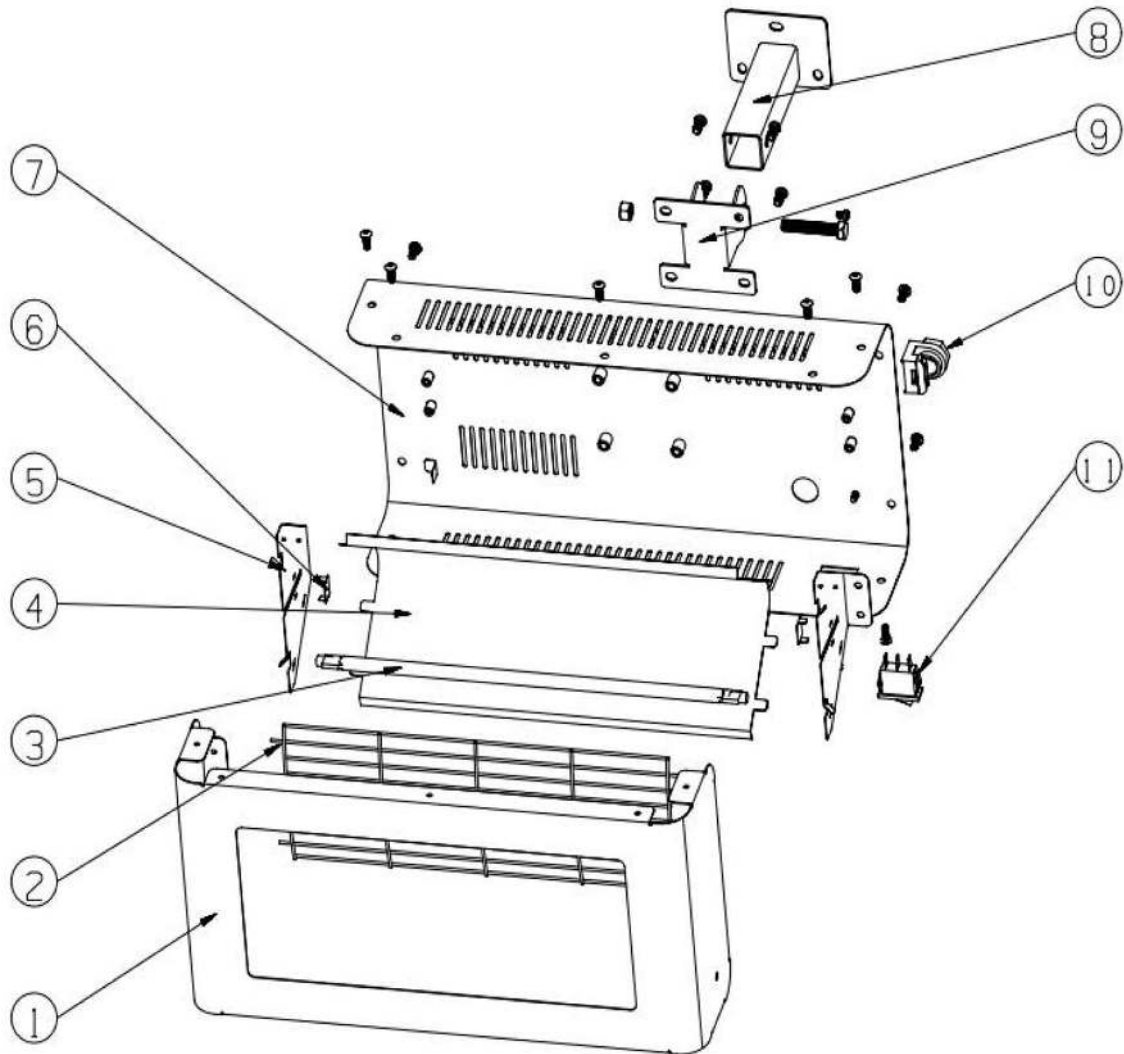

# PARTS LIST

No	Description
1	Front Case
2	Front Grille
3	230V 1200W Heating Tube
4	Reflector
5	Reflector Side Plate
6	Reflector Bracket

No	Description
7	Main Case
8	Wall Mounting Bracket
9	Unit Mounting Bracket
10	Cable Gland
11	ON/OFF Rocker Switch

## FAULT FINDING

SYMPTOM	PROBLEM	SOLUTION
Heater does not operate, although plugged in and switched on.	Plug is loose/bad connection.	Remove the plug & check the connection of the plug and socket.
	Fuse blown.	Replace if necessary and investigate the cause. If fuse blows repeatedly, consult your CLARKE dealer.
	No power at socket outlet.	Insert plug into a suitable socket.
Heater tube is glowing hot.	Input voltage incorrect.	Ensure power supply matches the rating on the label.
	Air supply partly blocked.	Ensure the heater is kept away from any objects or materials which could impair the fresh air supply.

## ENVIRONMENTAL RECYCLING POLICY



Through purchase of this product, the customer is taking on the obligation to deal with the WEEE in accordance with the WEEE regulations in relation to the treatment, recycling & recovery and environmentally sound disposal of the WEEE.

In effect, this means that this product must not be discarded with general household waste. It must be discarded according to the laws governing Waste Electrical and Electronic Equipment (WEEE) at a recognised disposal facility.

# DECLARATION OF CONFORMITY - UKCA

**UK  
CA**

**Clarke**<sup>®</sup>  
**INTERNATIONAL**

Hemnall Street, Epping, Essex, CM16 4LG

## DECLARATION OF CONFORMITY

This is an important document and should be retained.

We hereby declare that this product(s) complies with the following legislation:

2009/125/EC	Ecodesign Directive
2014/30/EU	Electromagnetic Compatibility Directive
2014/35/EU	Low Voltage Directive
2011/65/EU	Restriction of Hazardous Substances (RoHS) Directive

The following standards have been applied to the product(s):

EN IEC 61000-3-2:2019+A1:2021+A2:2024, EN 61000-3-3:2013+A1:2019+A2:2021, EN 62233:2008,  
EN 60335-2-30:2009+A11:2012+A1:2020+A12:2020+A2:2022+A13:2022, EN IEC 55014-1:2021,  
IEC 62321-4:2013+A1:2017, EN IEC 55014-2:2021, IEC 62321-3-1:2013, IEC 62321-7-1:2015,  
EN 60335-1:2012+A11:2014+A13:2017+A1:2019+A2:2019+A15:2021+A16:2023,  
IEC 62321-7-2:2017, IEC 62321-5:2013, IEC 62321-6:2015, IEC 62321-8:2017

The technical documentation required to demonstrate that the product(s) meet(s) the requirement(s) of the aforementioned legislation has been compiled and is available for inspection by the relevant enforcement authorities.

The UKCA mark was first applied in: 2025

**Product Description:** Electric Radiant Heater  
**Model Number(s):** DEVIL 1200Q  
**Serial/Batch Number:** Refer to product/packaging label  
**Date of Issue:** 11/07/2025

**Signed:**



J.A Clarke  
Director

# DECLARATION OF CONFORMITY - CE



**Clarke**<sup>®</sup>  
**INTERNATIONAL**

Fitzwilliam Hall, Fitzwilliam Place, Dublin 2

## DECLARATION OF CONFORMITY

**This is an important document and should be retained.**

**We hereby declare that this product(s) complies with the following legislation:**

2009/125/EC	<i>Ecodesign Directive</i>
2014/30/EU	<i>Electromagnetic Compatibility Directive</i>
2014/35/EU	<i>Low Voltage Directive</i>
2011/65/EU	<i>Restriction of Hazardous Substances (RoHS) Directive</i>

**The following standards have been applied to the product(s):**

*EN IEC 61000-3-2:2019+A1:2021+A2:2024, EN 61000-3-3:2013+A1:2019+A2:2021, EN 62233:2008,  
EN 60335-2-30:2009+A11:2012+A1:2020+A12:2020+A2:2022+A13:2022, EN IEC 55014-1:2021,  
IEC 62321-4:2013+A1:2017, EN IEC 55014-2:2021, IEC 62321-3-1:2013, IEC 62321-7-1:2015,  
EN 60335-1:2012+A11:2014+A13:2017+A1:2019+A2:2019+A15:2021+A16:2023,  
IEC 62321-7-2:2017, IEC 62321-5:2013, IEC 62321-6:2015, IEC 62321-8:2017*

The technical documentation required to demonstrate that the product(s) meet(s) the requirement(s) of the aforementioned legislation has been compiled and is available for inspection by the relevant enforcement authorities.

**The CE mark was first applied in: 2025**

<b>Product Description:</b>	Electric Radiant Heater
<b>Model Number(s):</b>	DEVIL 1200Q
<b>Serial/Batch Number:</b>	Refer to product/packaging label
<b>Date of Issue:</b>	11/07/2025

**Signed:**

J.A Clarke

Director

# A SELECTION FROM THE VAST RANGE OF

# Clarke®

## QUALITY PRODUCTS



**AIR COMPRESSORS**  
From DIY to industrial, Plus air tools, spray guns and accessories.

**GENERATORS**  
Prime duty or emergency standby for business, home and leisure.

**POWER WASHERS**  
Hot and cold, electric and engine driven - we have what you need

**WELDERS**  
Mig, Arc, Tig and Spot. From DIY to auto/industrial.

**METALWORKING**  
Drills, grinders and saws for DIY and professional use.

**WOODWORKING**  
Saws, sanders, lathes, mortisers and dust extraction.

**HYDRAULICS**  
Cranes, body repair kits, transmission jacks for all types of workshop use.

**WATER PUMPS**  
Submersible, electric and engine driven for DIY, agriculture and industry.

**POWERTOOLS**  
Angle grinders, cordless drill sets, saws and sanders.

**STARTERS/CHARGERS**  
All sizes for car and commercial use.



## PARTS & SERVICE: 0208 988 7400

**Parts Enquiries**  
[Parts@clarkeinternational.com](mailto:Parts@clarkeinternational.com)

**Servicing & Technical Enquiries**  
[Service@clarkeinternational.com](mailto:Service@clarkeinternational.com)

SALES: UK 01992 565333 or Export 00 44 (0)1992 565335

**Clarke® INTERNATIONAL** Hemnall Street, Epping, Essex CM16 4LG  
[www.clarkeinternational.com](http://www.clarkeinternational.com)