

Canon

EF Lenses

EF50mm f/1.8 STM

Instructions

Thank you for purchasing a Canon product.

EF50mm f/1.8 STM is a compact, lightweight, low-profile high quality standard lens.

● “STM” stands for Stepping Motor.

Safety Precautions

- **Do not look at the sun or a bright light source through the lens or camera.** Doing so could result in loss of vision. Looking at the sun directly through the lens is especially hazardous.
- **Whether it is attached to the camera or not, do not leave the lens under the sun without the lens cap attached.** This is to prevent the lens from concentrating the sun's rays, which could cause a fire.

Handling Cautions

- **If the lens is taken from a cold environment into a warm one, condensation may develop on the lens surface and internal parts.** To prevent condensation in this case, first put the lens into an airtight plastic bag before taking it from a cold to warm environment. Then take out the lens after it has warmed gradually. Do the same when taking the lens from a warm environment into a cold one.
- Do not leave the lens in excessive heat such as in a car in direct sunlight.
High temperatures can cause the lens to malfunction.

Usage Precautions

- When using this lens, please check the Canon website for the latest camera firmware. If the camera's firmware is not the latest version, be sure to update to the latest firmware.
- For details on updating firmware, please check the Canon website.

Cautions during shooting

- This lens uses a stepping motor to drive the focusing lens (the lens that has the job of focusing the shot).
 1. Cautions when the power is off
Since the motor does not operate when the camera is off or has been turned by the auto power-off function, take note of the following points.
 - The focus cannot be adjusted in manual focus mode.
 2. Cautions when the lens is in sleep mode
This lens has a sleep mode separate from the camera auto power-off function for saving power when the lens has not been operated for a period of time.
Since the motor does not operate when the lens is in sleep mode, even if the camera is turned on, take note of the following points.
 - The focus cannot be adjusted in manual focus mode.
 - To recover the lens from sleep mode, press the shutter button halfway.

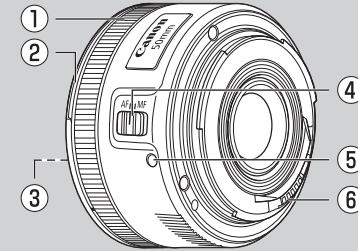

Nomenclature

- ① Focusing ring
- ② Hood mount
- ③ Filter mounting thread
- ④ Focus mode switch
- ⑤ Lens mount index
- ⑥ Contacts





- To retract the lens if extended, keep the lens attached to the camera, and then autofocus at infinity or turn the focusing ring.

Conventions used in this instruction

-  Warning to prevent lens or camera malfunction or damage.
-  Supplementary notes on using the lens and taking pictures.

1. Mounting and Detaching the Lens

See your camera's instructions for details on mounting and detaching the lens.

-  After detaching the lens, place the lens with the rear end up to prevent the lens surface and contacts from getting scratched.
- If the contacts get soiled, scratched, or have fingerprints on them, corrosion or faulty connections can result. The camera and lens may not operate properly.
- If the contacts get soiled or have fingerprints on them, clean them with a soft cloth.
- If you remove the lens, cover it with the dust cap. To attach it properly, align the lens mount index and the ○ index of the dust cap, and turn clockwise . To remove it, reverse the order.

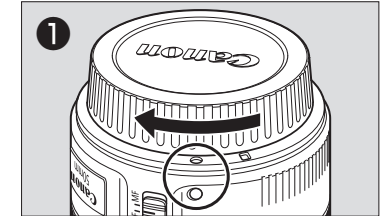

2. Setting the Focus Mode

To shoot in autofocus (AF) mode, set the focus mode switch to AF ②.
To shoot in manual focus (MF) mode, set the focus mode switch to MF, and turn the focusing ring to set the focus ③.

 When the camera AF mode is ONE SHOT AF, focus manually by pressing the shutter button halfway and turning the focusing ring. (Full-time manual focus)

- 
 - When turning the focusing ring suddenly, the focus adjustment may be delayed.
 - The focus cannot be adjusted in MF mode while the camera is off.
 - Do not touch the front rotating parts of the lens while autofocus is active.

3. Hood (Sold Separately)

The ES-68 hood can keep unwanted light out of the lens, and also protects the lens from rain, snow, and dust.

To attach the hood, align the hood's attachment position mark with the red dot on the front of the lens, then turn the hood in the direction of the arrow until the lens's red dot is aligned with the hood's stop position mark ④.

To remove the hood, hold down the button on the side and turn the hood in the direction of the arrow until the position mark on the hood aligns with the red dot ⑤. The hood can be reverse-mounted on the lens for storage.

- 
 - Part of the picture may be blocked if the hood is not attached properly.
 - When attaching or detaching the hood, grasp the base of the hood to turn it. To prevent deformation, do not grasp the rim of the hood to turn it.
 - If the lens is attached to the camera with the hood reverse-mounted, remove the hood before removing the lens from the camera.

4. Filters (Sold Separately)

You can attach filters to the filter mounting thread (ø49 mm) on the front of the lens.

-  Only one filter may be attached.

5. Extension Tubes (Sold Separately)

You can attach extension tube EF12 II or EF25 II for magnified shots. For shooting distance and magnification, see the extension tube specifications.

 MF mode is recommended for accurate focusing.

- The lens length is measured from the mount surface to the front end of the lens. Add 23.9 mm when including the lens cap and dust cap.
- The size and weight listed are for the lens only, except as indicated.
- The extenders cannot be used with this lens.
- The close-up lenses cannot be used with this lens. (The end of the lens will become heavy, causing the focus to become unstable.)
- CASE (Sold Separately) LP1014
- All data listed is measured according to Canon standards.
- Product specifications and appearance are subject to change without notice.

This device complies with Part 15 of the FCC Rules. Operation is subject to the following two conditions: (1) This device may not cause harmful interference, and (2) this device must accept any interference received, including interference that may cause undesired operation.

Do not make any changes or modifications to the equipment unless otherwise specified in the instructions. If such changes or modifications should be made, you could be required to stop operation of the equipment.

This equipment has been tested and found to comply with the limits for a class B digital device, pursuant to part 15 of the FCC Rules.

These limits are designed to provide reasonable protection against harmful interference in a residential installation. This equipment generates, uses and can radiate radio frequency energy and, if not installed and used in accordance with the instructions, may cause harmful interference to radio communications. However, there is no guarantee that interference will not occur in a particular installation. If this equipment does cause harmful interference to radio or television reception, which can be determined by turning the equipment off and on, the user is encouraged to try to correct the interference by one or more of the following measures:

- Reorient or relocate the receiving antenna.
- Increase the separation between the equipment and receiver.
- Connect the equipment into an outlet on a circuit different from that to which the receiver is connected.
- Consult the dealer or an experienced radio/TV technician for help.

CAN ICES-3(B)/NMB-3(B)

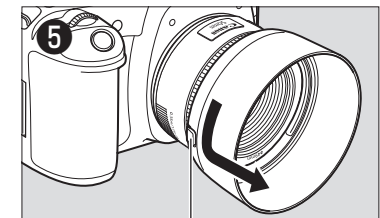
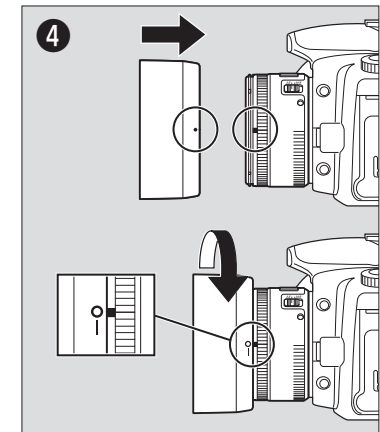
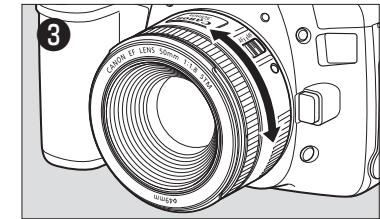
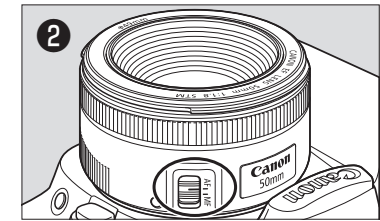

Button

Extension Tube Specifications
(Sold Separately)

		Magnification (X)	Focusing Distance Range (mm) (inch)
EF50mm f/1.8 STM	EF12 II	0.45-0.24	234-325 (9.2-12.8)
	EF25 II	0.74-0.53	204-221 (8.0-8.7)

Specifications

* Sold Separately

	Angle of view			Lens construction	Minimum aperture	Max. magnification	Min. focusing distance	Filter diameter	Max. diameter and length	Weight	Hood*	Lens Cap	Case*
	Diagonal	Vertical	Horizontal										
EF50mm f/1.8 STM	46°	27°	40°	5-6	22	0.21x	0.35m/1.15ft	49mm	69.2x39.3mm (2.7"x1.6")	160g/5.7oz.	ES-68	E-49	LP1014