

2.1 SOUNDBAR SPEAKER SYSTEM

Dolby Digital/Digital Plus BT Sound Bar with Subwoofer

Model No.: AAVANTE BAR 1700D

Bluetooth Name: Aavante Bar 1700D



Discover a new level of immersive, cinematic audio experience at home with the boAt AAVANTE BAR 1700D. With a powerful 120 W total output, a slim sound bar and versatile 2-way subwoofer brings every aspect of your entertainment be it a song, show or movie to life in the volume and clarity it deserves. Drivers at each end of your sound bar deliver a clear mid and high range, while a 60 W subwoofer fills in the rumbling lows. The 2.1 channel sound system provides a balanced sound and deep bass for your movies, music and even video games and you can experience cinematic sound that revolves around you. Stay plugged into the sound with an array of wired connections, and Bluetooth® wireless technology.

It is equipped with Dolby Digital/Digital Plus technology for an enthralling auditory experience. Dolby Digital/Digital Plus features greatly improved sound, more channels, less compression, and a more realistic audio experience as compared to standard-definition audio formats. At higher bit rates it is virtually indistinguishable from the source audio.

Bring your home to life with the Aavante Bar 1700D.

A portrait of actor Kartik Aaryan against a vibrant red background. He has dark, styled hair and a beard, looking directly at the camera with a slight smile. His right arm is raised, with his hand resting on his shoulder. He is wearing a black t-shirt with the 'boat' logo in white and red, and the tagline 'plug into nirvana' below it.

boat
plug into nirvana

Kartik Aaryan
Kartik Aaryan

Controls and connections

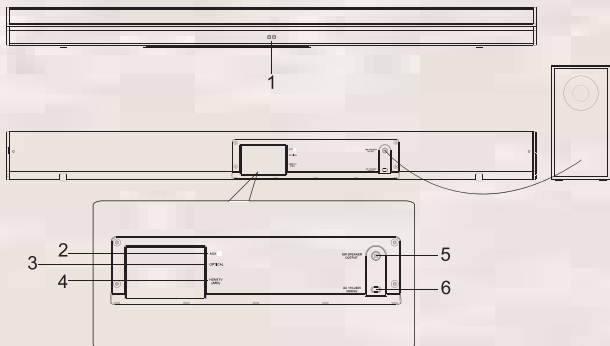

1. DISPLAY

2. AUX

3. OPTICAL

4. HDMI(ARC)

5. SUBWOOFER PORT

6. AC 110-240V 50/60Hz

Controls and connections

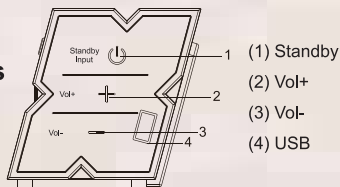

(1) Standby

(2) Vol+

(3) Vol-

(4) USB

SPECIFICATIONS

Model	boAt AAVANTE BAR 1700D
Technology	USB/BT/AUX/Optical/HDMI(ARC)
CODEC	Dolby Digital/Digital Plus
Drivers	2.25"*4 SB + 6.5inch SW
Output Power	30W*2+60W=120W R.M.S.
Frequency Response	45Hz-20KHz
Signal-to-Noise Ratio	≥ 72dB
Impedance	4Ω*4+4Ω
Power Input	SMPS 110V-240V
Bluetooth	V5.0, Range: 10m
Dimensions	Sound bar:73H*78D*960L mm Subwoofer: 190W*368H*315D mm

Remote Control - Control/Functions

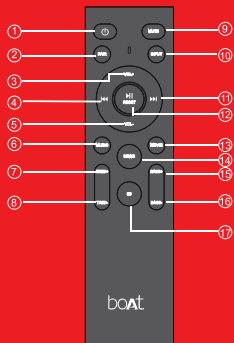

1. : Standby mode for power on/off/ Multifunction Button .
2. PAIR: Connect or disconnect to the pairing device. (Press the button more than 2 seconds).
3. Volume+ : Master volume up
4. : Pre button: Previous program (Only work under USB & BT Mode).
5. Volume - : Master volume down
6. MUSIC: Select the Music EQ effect.
7. TR+: Treble Intensity up.
8. TR-: Treble Intensity down.
- 9.MUTE: Mute mode.
- 10.INPUT: Input mode(AUX/USB/HDMI (ARC)/OPT/BT).
11. : Next button: Next program. (Only work under USB and BT mode).
12. : Play/Pause (Only work under USB and BT mode).
13. MOVIE: Select the Movie EQ effect.
14. NEWS: Select the News EQ effect .
15. Bass + : Bass Intensity Up.
16. Bass - : Bass Intensity Down.
17. 3D: Select the 3D EQ effect.

Remote Control Battery Replacement

Please insert the batteries as indicated below

A: Remove the battery compartment cover



B: Insert 2 AAA batteries according to the markings inside compartment



C: Close the compartment.



Positioning the Sound Bar

Place on a flat Surface

Place the sound bar horizontally on a flat surface such as a TV unit or shelves and align it centrally with the TV screen. Allow some space between the speaker and the wall. Don't place inside a cabinet or on a walled shelf. Follow this guidance for best sound output and good airflow around the sound bar.



Mount on the wall

WARNING: If you don't feel confident to correctly and securely wall-mount the sound bar, Seek the assistance of an experienced person or professional.

Install the speaker on a vertical, fast, reinforced area of wall. For plaster walls, it is recommended to screw into wall studs for greater security. For optimum performance, allow at least 25mm/1" distance between the sound bar and the TV.

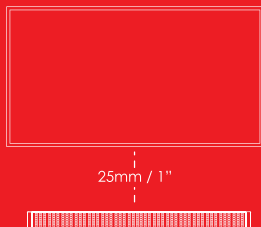
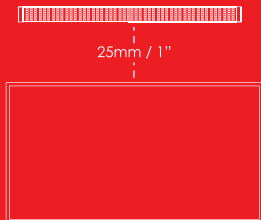

OPERATION INSTRUCTIONS

Setting the Soundbar

- 1: Plug in the power cord and the display will light up (Standby mode)
- 2: Switch on the soundbar by using power button on soundbar or by using STANDBY button on remote. After switching on, the default input mode will appear on display
- 3: Input mode can be changed by pressing the power button again or by using the INPUT button on remote
- 4: Below are input mode names appearing in the soundbar display:
BT -Bluetooth Pairing mode, **FL**-AUX mode, **OP**-Optical mode, **HD** -HDMI mode, **US** -USB mode, **DB** -Dolby mode
5. To turn off, press and hold the multi-function button for 2 seconds or unplug from wall outlet

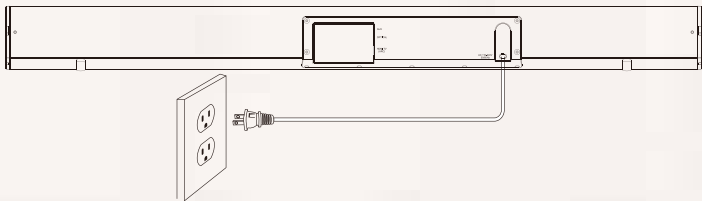

Note: For Dolby Digital/Digital Plus audio, you can play the movies or videos that contain Dolby Digital/Digital Plus technology under Optical or HDMI (ARC) mode. Go to the Sound or Speakers menu of the TV/Computer and select External Speakers or Audio System. Refer to the TV's sound settings / computer's audio control panel to select the audio system.

The soundbar LED will display 'DB' while the videos with Dolby Digital/Digital Plus technology gets played. If you use set top box or any other media device such as Blu ray other than TV then the LED won't display 'DB', though the Dolby audio will be played regardless of that.

Playing Audio via BT Connection

1. Turn on sound bar and then short-press the multi-function button to switch to BT mode and the LED will show **BT**
2. Activate the pairing function on your phone or other compatible device and select "Aavante Bar 1700D"
3. When successfully paired, you will hear a tone and the LED Display will stay on **BT**
4. The remote control includes BT mode playback controls

Notes:

- If your pairing device gets switched off or gets manually disconnected, the sound bar will automatically enter pairing mode
- Successful connection will be re-established with the already paired device(s) once you re-enter wireless range (10m). To connect to other devices, repeat the above pairing steps.
- There is no automatic shutdown in pairing mode. The sound bar will remain in pairing mode even if no device is paired, so switch off if not in use

AUX mode

- Connect the sound bar to your PC, tablet, smartphone, TV, or other device using the included audio cable. Short-press the multi-function button to switch to audio input mode with the LED Display lit up (AUX)
- In this mode, playback can only be controlled on your connected device

Note: For some computers, you may need to access the audio control panel to manually set the sound bar as below picture



Playing Audio via USB Port

The sound bar automatically switches to USB input mode with the LED display (U5) when a USB flash drive is inserted (this mode isn't selectable on the sound bar or remote control unless a USB flash drive is connected).

1. Ensure that your USB flash drive contains MP3 or WMA audio files (other file types not supported)
2. Connect the USB flash drive to the USB port on the sound bar (or your own USB extension cable connected to the USB port); music will automatically play
3. The remote control includes USB input mode playback controls

Optical Mode

Use this operating mode to play music from the optical digital input for example from a TV on your soundbar. The TV must have an optical digital output. Use an optical cable to make the connection.

Proceed as follows:

- Connect the optical cable to the optical digital output of your TV.
- Then connect the optical cable to the optical digital input of your soundbar.
- Switch the TV set and sound bar on. Set the connected TV to "PCM Stereo" or "Stereo 2.1"(For any doubt or details please refer to the TV manual).
- Start playing on the TV.
- Press the INPUT button on the remote control to select this mode.
- Once switched to Optical mode, the LED will display 'OP'.
- You can use the volume buttons to adjust the volume to your requirements.
- If you wish, you can change the audio settings using the relevant buttons on the remote control.

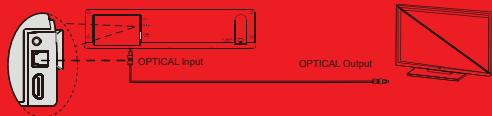

HDMI Mode

1. The Soundbar supports HDMI with Audio Return Channel(ARC). If your TV is HDMI ARC compliant, you can hear the TV audio through your Soundbar by using a single HDMI cable
2. Using an HDMI compatible cable, connect the HDMI TV(ARC) connector on the soundbar to the HDMI ARC connector on the TV. The HDMI ARC connector on the TV might be labelled differently. For details, see the TV user manual.

Once switched to HDMI Mode, the LED will display 'Hd'.

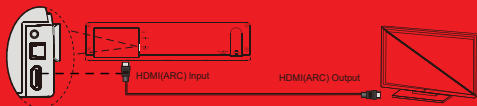

Important Safety Instructions

Caution:

To reduce the risk of electric shock, do not dismantle the AAVANTE Bar 1700D and do not expose the apparatus to rain or moisture.



Important Safety Instructions

Caution:



This symbol alerts you about the presence of uninsulated dangerous voltage within the product's enclosure that may be of sufficient magnitude to constitute an electric shock to a person or persons.



Important! This symbol alerts you to read and observe important warnings and instructions on the unit or in this manual.

Important Notes

- Before turning on the power for the first time, make sure the power adaptor is properly connected.
- This sound bar is specially developed for LED/LCD/Plasma & Smart TV's: It should not be used in combination with CRT TV's (Cathode Ray Tube TV's) in order to avoid image interferences.
- Do not attempt to remove any screws, or open the casing of the unit; there are no user serviceable parts inside. Refer all servicing to qualified service personnel.
- Operate the soundbar only as instructed in this manual and this instruction manual should be retained for future reference.
- If connected to a TV via Bluetooth there may be a sound lag between the TV and the device. To solve this, the best option is to connect the TV and Soundbar using an aux/ optical/ HDMI output.
- The Soundbar may not be compatible with all Bluetooth capable TV's. In this case, please use an aux/ optical/ HDMI output to connect the Tv and Soundbar to one another.

Please ensure that the boAt AAVANTE Bar 1700D is not exposed to the following:

- Dropping or splashing water or placed in a humid atmosphere such as a bathroom.
- places exposed to direct sunlight or close to radiators.
- On top of other stereo equipment that radiate too much heat.
- Blocking ventilation or in a dusty area.
- Areas where there is constant vibration.
- Humid or moist places.
- Do not place the sound bar near candles or other naked flames.

Safety Instructions

Power sources - This soundbar should be operated only from the type of power source indicated by the marking adjacent to the power cord entry.

Grounding - the soundbar is not required to be grounded. Ensure that the plug is fully inserted into the wall socket or extension cable to prevent pin exposure.

Power cord protection - Power-supply cords should be routed so that they are not likely to be walked on, kinked or pinched by items placed on or against them, paying particular attention to cords from plugs.

Overloading - Do not overload wall sockets, extension cables, as this can result in a risk of a fire or electric shock.

Ventilation - The soundbar must be properly ventilated. Do not place the soundbar on a bed, sofa, or other similar surface. Do not cover the soundbar with any items such as table clothes, newspapers, etc.

Heat -The soundbar should be situated away from heat sources such as radiators, stoves, or other devices, including amplifiers that produce heat. No naked flame sources, such as lighted candles, should be placed on the Sound bar or sub-woofer.

Water and moisture -To reduce the risk of fire or electric shock, do not expose the soundbar to rain, dripping, splashing or excessive moisture such as in a sauna or bathroom. Do not use this soundbar near water, for example, near a bathtub, washbowl, kitchen sink, laundry tub, wet basement or near a swimming pool (or similar).

Object and Liquid Entry - Never push objects of any kind into this soundbar through openings, as they may touch dangerous voltage points or short-circuit parts that could result in a fire or electric shock. Never spill liquid of any kind on the soundbar. Do not place any object containing liquid on top of the soundbar.

Accessories - Do not place this soundbar on an unstable stand, tripod, bracket or table. The soundbar may fall, causing serious injury to a child or adult, and serious damage to the soundbar.

Unused periods -The power cord of the soundbar should be unplugged from the mains during lightning storms or when the apparatus is left unused for a long period of time.

Safety Instructions (Cont.)

Servicing - Do not attempt to service this soundbar yourself, as opening or removing covers may expose you to dangerous voltage or other hazards and will void your warranty

Mains fuses - For continued protection against fire hazard, use fuses only of the correct type and rating. The correct fuse specification for each voltage range is marked on the soundbar.

Do not turn up the volume while listening to a section with very low level inputs or no audio signals. If you do, the speaker may be damaged when a peak level section is suddenly played.

Try to install the soundbar near a wall socket or extension cord to make sure that it is easily accessible.

The highest environmental temperature suitable for this soundbar is 35°C. If the soundbar doesn't respond to operation of control due to electrostatic discharge, just switch off and reconnect again, or move the soundbar to another location away from the TV

Battery

- 1). The batteries must not be exposed to excessive heat such as sunshine, fire etc.
- 2). The batteries should be drawn to the environmental aspects of battery disposal.
- 3). **Battery usage** - to prevent battery leakage which may result in body injuries, property damage, or damage to the apparatus: Install all batteries correctly, + and - as marked on the apparatus. Do not mix batteries (old and new or carbon and alkaline, etc.) Remove batteries when the unit is not used for a long time.

Important Notes

- If connected to a TV via Bluetooth there may be a sound lag between the TV and the device. To solve this, the best option is to connect the TV and Soundbar using an aux/ optical/ HDMI output.
- The Soundbar may not be compatible with all Bluetooth capable TV's. In this case, please use an aux/ optical/ HDMI output to connect the Tv and Soundbar to one another.

Warning

This soundbar is not intended for use by persons (including children) with reduced physical sensory or epilepsy, or lack of experience and knowledge, unless they have been given supervision or instructions concerning use of by a person responsible for their safety.

1. To prevent possible hearing damage, do not listen at high volume levels for long periods of time or a sudden high volume level.
2. Switch off the device whenever you are not using it, even if this only for a short while.
3. The soundbar is not intended to be operated by means of an external timer or separate remote-control system.
4. Before operating this device, check the voltage of this system to see if it is identical to the voltage of your local power supply.
5. The unit should not be impeded by covering the ventilation opening with items such as newspaper, table-cloths, curtains etc. Make sure that there are at least 20 cm of space above and at least 5 cm of space on each side of the unit.
6. The soundbar must not be exposed to dripping or splashing and that objects filled with liquids, such as vases, must not be placed on the apparatus.
7. To prevent fire or shock hazard, do not expose this device to hot places, rain, moisture or dust.
8. Do not locate this device near any water sources e.g. taps, bathtubs, washing machines or swimming pools. Ensure that you place the unit on a dry, stable surface.
9. Do not place this device close to a strong magnetic field.
10. Do not place the device on an amplifier or receiver.
11. When removing the power plug from the wall socket, always pull directly on the plug, never pull on the cord.
12. Depending on the electromagnetic waves used by a television broadcast, if a TV is turned on near this unit while it is also on, lines might appear on the TV screen.
13. Neither this unit nor the TV is malfunctioning. If you see such lines, keep this unit well away from the TV set.

Trouble Shooting

No sound

- Check that the Sound bar system is not set to standby.
- Check that the correct source is selected.

No sound/low volume

(Computer or personal audio player connected to the AUX Port)

- If the source has a volume control, check that this is turned up.

No sound (digital audio source)

- Check that the sample rate of the source is in the correct range for the sound bar system.

No remote control operation

- The batteries may be flat. Try replacing the batteries.

boAt
plug into nirvana

CONNECT WITH US ON



boAt-lifestyle.com



facebook.com/boat.nirvana



instagram.com/boat.lifestyle1

boAt
plug into nirvana

Hardik Pandya

Hardik Pandya