

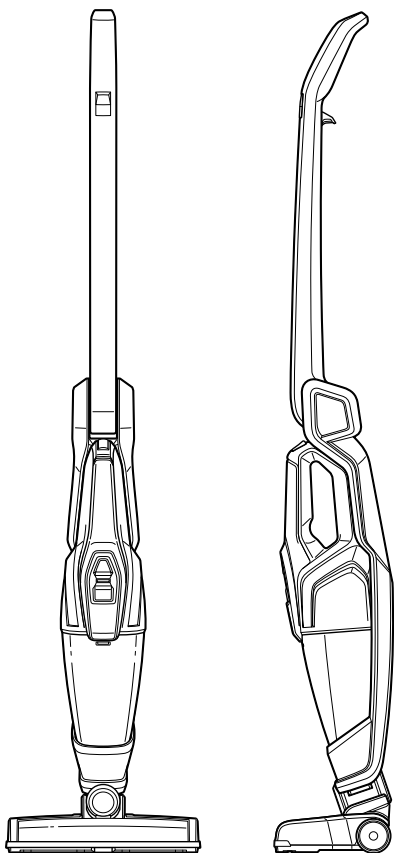

ADAPT™ ION PET

2-in-1 Cordless Vacuum

USER GUIDE
2286 SERIES



IMPORTANT SAFETY INSTRUCTIONS

READ ALL INSTRUCTIONS BEFORE USING YOUR STICK VACUUM. Always connect to outlet for charging. Unplug from outlet when not in use and before conducting maintenance. When using an electrical appliance, basic precautions should be observed, including the following:

WARNING TO REDUCE THE RISK OF FIRE, ELECTRIC SHOCK OR INJURY:

- » Do not use outdoors or on wet surfaces.
- » Do not allow to be used as a toy. Close attention is necessary when used by or near children.
- » Children should be supervised to ensure that they do not play with the appliance.
- » Do not use for any purpose other than described in this user guide. Use only manufacturer's recommended attachments.
- » Do not use with damaged cord or plug. If appliance is not working as it should, has been dropped, damaged, left outdoors, or dropped into water, have it repaired at an authorized service center.
- » Do not put any object into opening.
- » Do not use with any opening blocked.
- » Do not unplug by pulling on cord. To unplug, grasp the plug, not the cord.
- » Do not handle charger, including charger plug and charger terminal with wet hands.
- » Do not charge the vacuum outdoors.
- » Use only the charger supplied by the manufacturer to recharge.
- » Do not incinerate the appliance even if it is severely damaged. The batteries can explode in a fire.
- » Keep openings free of dust, lint, hair, and anything that may reduce airflow.
- » Keep hair, loose clothing, fingers, and all parts of body away from openings and moving parts.
- » Use extra care when cleaning stairs.
- » Do not use to pick up flammable or combustible materials (lighter fluid, gasoline, kerosene, etc.) or use in areas where they may be present.
- » Do not pick up toxic material (chlorine bleach, ammonia, drain cleaner, etc.).
- » Do not use vacuum cleaner in an enclosed space filled with vapors given off by oil-based paint, paint thinner, some moth-proofing substances, flammable dust, or other explosive or toxic vapors.
- » Do not pick up hard or sharp objects such as glass, nails, screws, coins, etc.

- » Do not pick up anything that is burning or smoking, such as cigarettes, matches or hot ashes.
- » Do not use without Dirt Tank or filters in place.
- » Use only on dry, indoor surfaces.
- » Always turn OFF this appliance before connecting or disconnecting the motorized nozzle.
- » Do not pull or carry charger by the cord, use cord as a handle, close a door on cord, or pull cord around sharp edges or corners. Do not run appliance over cord.
- » Prevent unintentional starting. Ensure the switch is in the OFF-position before picking up or carrying the appliance. Carrying the appliance with your finger on the switch or energizing appliance that have the switch on invites accidents.
- » Under abusive conditions, liquid may be ejected from the battery; avoid contact. If contact accidentally occurs, flush with water. If liquid contacts eyes, additionally seek medical help. Liquid ejected from the battery may cause irritation or burns.
- » Do not use appliance that is damaged or modified. Damaged or modified batteries may exhibit unpredictable behavior resulting in fire, explosion or risk of injury.
- » Do not expose appliance to fire or excessive temperature. Exposure to fire or temperature above 130°C/265°F may cause explosion.
- » Follow all charging instructions and do not charge the appliance outside of the temperature range specified in the instructions. Charging improperly or at temperatures outside of the specified range may damage the battery and increase the risk of fire.
- » Have servicing performed by a qualified repair person using only identical replacement parts. This will ensure that the safety of the product is maintained.
- » Do not modify or attempt to repair the appliance except as indicated in the instructions for use and care.
- » Do not recharge, disassemble, heat above 60°C / 140°F, or incinerate.
- » Do not immerse in water or liquid.
- » Do not expose appliance to fire or excessive temperature. Exposure to fire or temperature above 130°C / 265°F may cause explosion.
- » Keep the temperature range of between 4-40°C / 40-104°F when charging battery, storing unit or during use.
- » Use only with charger SIL, Model ZD5FZ30030US.
- » Recharge only with the charger specified by the manufacturer. A charger that is suitable for one type of battery pack may create a risk of fire when used with another battery pack.
- » Plastic film can be dangerous. To avoid danger of suffocation, keep away from children.
- » If the charger supply cable is damaged, it must be replaced by the manufacturer, its service agent or similarly qualified person in order to avoid a hazard.
- » Keep charger cable away from heated surfaces.
- » Battery pack and charger base output terminals are not to be short-circuited.
- » The appliance must be disconnected from the supply mains when removing the battery.
- » The battery is to be disposed of safely.
- » Keep batteries out of reach of children.
- » The battery must be removed from the accessory before it is scrapped. Recycle batteries, do not mix with household waste. For your convenience or information only on your battery disposal, please contact RBRC (Rechargeable Battery Recycling Corporation) at 1-877-2-RECYCLE or visit www.Call2Recycle.com
- » Never put batteries in mouth. If swallowed, contact your physician or local poison control.
- » This appliance contains batteries that are only replaceable by skilled persons.
- » This appliance contains batteries that are non-replaceable.
- » The battery must be removed from the appliance before it is scrapped.
- » Turn OFF all controls before unplugging.

SAVE THESE INSTRUCTIONS FOR FUTURE USE

This model is for household use only.

Thanks for buying a BISSELL® Adapt™ Ion Pet!

We love to clean and we're excited to share one of our innovative products with you. We want your vacuum to work like new for the years to come, so this guide has tips on how to use, maintain and, if there's a problem, troubleshoot.

Your vacuum needs a little assembly before getting to work, so flip to the "Assembly" section and let's get started!

What's In The Box?

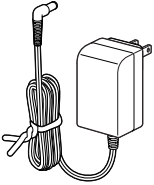

Charging
Adapter

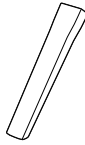

Crevice
Tool



Upholstery
Tool



Multi-Surface
Brush Roll

NOTE: Standard accessories may vary by model. To identify what should be included with your purchase, please refer to the "Carton Contents" list located on the carton top flap.

Safety Instructions.....2

Product View.....4

Assembly4

Operations5-6

Maintenance & Care7-9

Troubleshooting10

Warranty11

Product Registration..... 12

Product View

- 1 Fingertip Controls
- 2 2-Way Folding Handle Release Trigger
- 3 Hand Vacuum Release Button
- 4 Hand Vacuum Power Button
- 5 Dirt Tank Release
- 6 Charging Light Indicator
- 7 Detachable Hand Vacuum
- 8 Dirt Tank
- 9 Washable Filter Assembly
- 10 Swivel Head
- 11 Crevice Tool
- 12 Upholstery Tool
- 13 Charging Adapter Plug

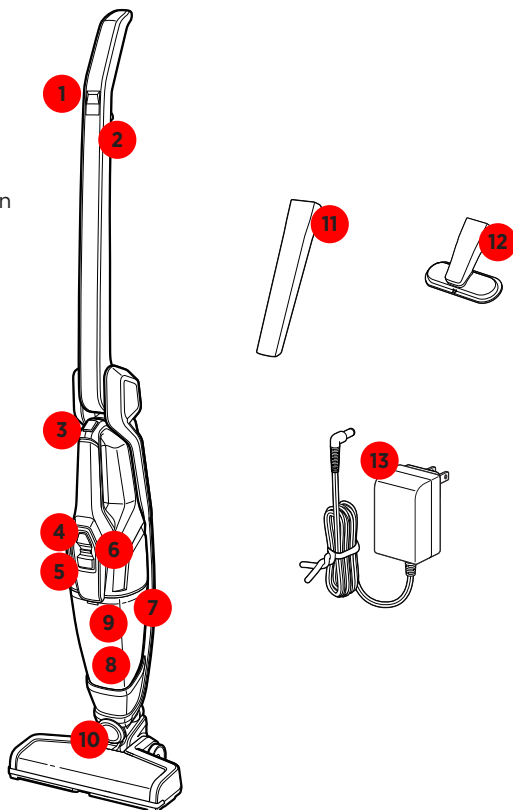

Assembly

WARNING

Do not plug in your Adapt Ion Pet until you are familiar with all instructions and operating procedures.

Your BISSELL® Adapt™ Ion Pet vacuum comes in two easy-to-assemble components and does not require any tools to assemble.

1

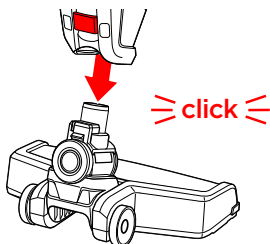

Insert foot into body of the vacuum until you hear a "click".

Charging

1

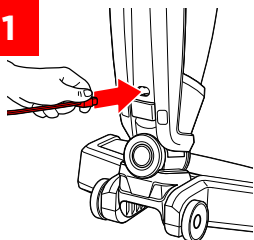

Insert Charging Adapter Plug into the charging port on the back of the vacuum.

2

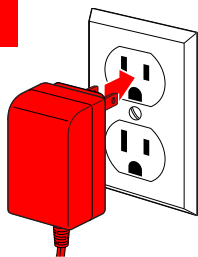

Plug the adapter into the wall outlet.

3



Charge the vacuum completely for 8 hours prior to first use.

LED Light Display Status

Battery Status	Light Status
IN USE	
In Use	Solid green light
Low Power	Blinking red light
No Power	Solid red light (3 seconds)
Brush Stall	Solid red light, then vacuum shuts OFF
CHARGING	
Charging	Blinking red light (1 second)
Fully Charged	Green light (on 10 minutes, then blinks every 1 minute)
Charger, Battery, or Motor Issue	Red and green blinking light, contact Consumer Care

Using your Adapt™ Ion Pet

1



To start cleaning select the power button to turn the vacuum ON.

2



Select the brush button to turn the motorized Brush Roll OFF and ON.

Operating 2-Way Folding Handle

1

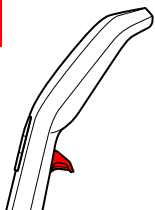

Find the 2-Way Folding Handle Release Trigger located under the handle.

2

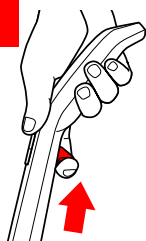

Pull the trigger to fold the handle.

3

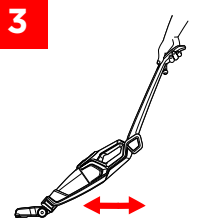

Fold the handle forward to easily clean underneath low places.

4



Fold the handle back for easy storage.

Using the Removable Hand Vacuum

1

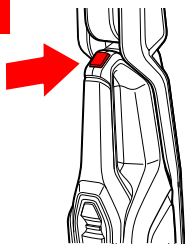

Press the button located on top of the hand vacuum handle and lightly pull out to remove it from the machine.

2

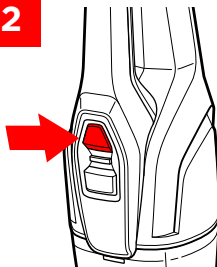

Press the Power Button to begin cleaning.

Using the Hand Vacuum Tools

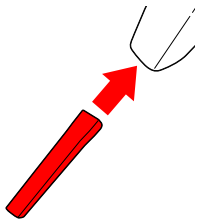

Your purchase comes with specially design tools to make pet cleanup easier. To attach any of the included tools, remove the hand vacuum from the base of the machine and insert the desired tool firmly into the hand vacuum nozzle.

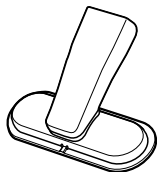

The Upholstery Tool has a felt strip that attracts pet hair while vacuuming upholstery.



The Crevice Tool reaches narrow spaces.

Emptying the Dirt Tank

⚠️ WARNING

- » To reduce the risk of fire, electric shock or injury, turn power OFF and disconnect plug from electrical outlet before performing maintenance or troubleshooting.
- » Do not operate your Adapt™ Ion Pet with damp or wet filters or without filters in place.

1

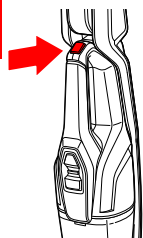

Make sure the vacuum is OFF. Remove the hand vacuum by pressing the release button on its top handle.

2



Hold the hand vacuum vertically and press release button on the front to release the Dirt Tank.

3

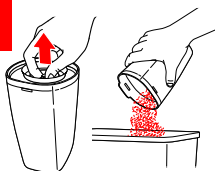

Grasp filter tabs and pull up to remove filter assembly and empty dirt into trash container.

4

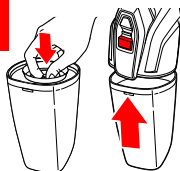

Replace filter assembly back into the Dirt Tank and attach Dirt Tank to hand vacuum until it snaps securely into place.

Cleaning the Filters

1

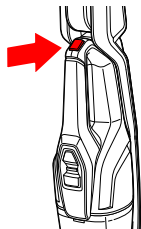

Turn power OFF and remove the Dirt Tank as directed in “Emptying the Dirt Tank” section.

2

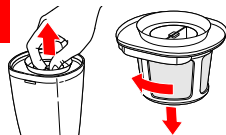

Grasp filter tabs and lift up to remove the Washable Filter Assembly from the Dirt Tank. Grip the Filter Assembly and turn counter-clockwise and lift up to remove filter from filter screen.

3

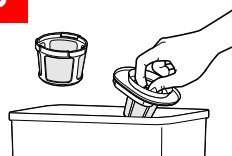

Tap firmly against the inside of a trash container, removing any visible dirt.

4

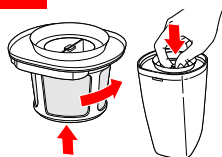

Replace filter back into the filter screen then turn clockwise to lock into place. Attach filter assembly back into the Dirt Tank and attach to hand vacuum until it snaps securely in place.

NOTE: You may rinse the filter and screen in warm water to clean. The filter and screen need to be 100% dry before reuse. The key to maximum performance is having a clean filter. Cleaning the filter after each use will help your vacuum operate at peak efficiency.

Maintaining the Brush Roll

⚠️ WARNING

To reduce the risk of fire, electric shock or injury, turn power OFF and disconnect plug from electrical outlet before performing maintenance or troubleshooting.

1

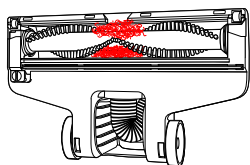

If the Brush Roll stops spinning due to debris, the LED light will turn solid red.

2

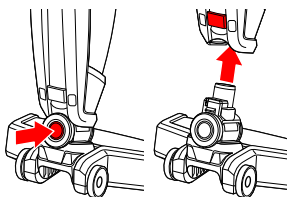

Make sure the vacuum is OFF. Press the vacuum foot release button to disconnect it from the vacuum.

3

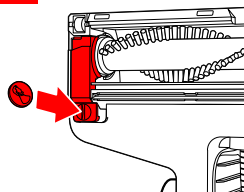

Turn the foot over and find the brush roll cover tab. Use a coin to remove the Brush Roll, turning counter-clockwise to unlock.

4

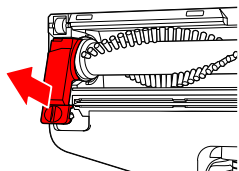

Slide the tab down to un-lock and lift the corner cover piece.

5

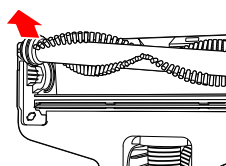

Grasp the Brush Roll and remove from the foot window area. Clean off hair or debris from brush.

6

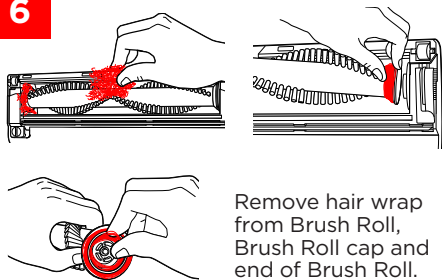

Remove hair wrap from Brush Roll, Brush Roll cap and end of Brush Roll.

7

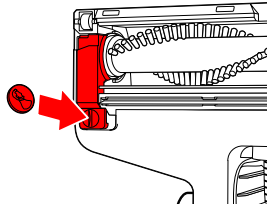

Once Brush Roll is clean of debris and wrapped hair, place back into the foot and use coin to turn lock clockwise to lock into position. Turn vacuum ON to reset.

NOTE: Make sure the Brush Roll cover tab is locked into place to prevent damage to the brush.

Disposing the Batteries

WARNING

This product contains lithium-ion rechargeable batteries. According to Federal and State regulations, removal and proper disposal of lithium-ion batteries is required. For removal of the batteries in your Adapt™ Ion Pet, see instructions on this page.



NOTICE

Disconnecting the battery will destroy the appliance and void the warranty.

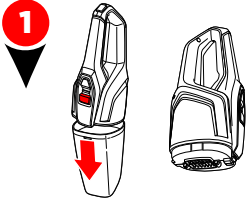

1 Ensure the vacuum is disconnected from the charger and powered OFF. Remove the Dirt Tank.

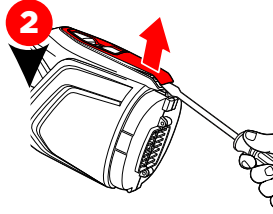

2 Using a flat-head screwdriver, pry off top cover of handle and remove it.

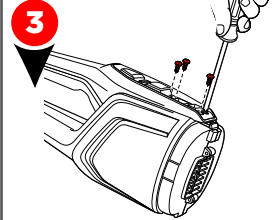

3 Using a Phillips-head screwdriver, remove the four screws.

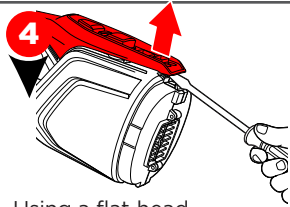

4 Using a flat-head screwdriver, pry off the cover where you just removed the screws from

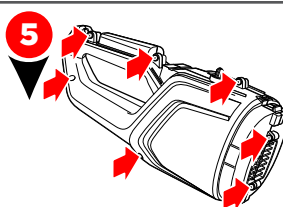

5 Using a Phillips-head screwdriver, remove 7 screws

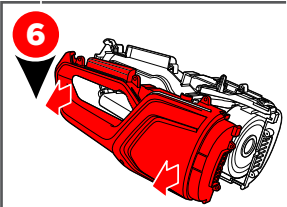

6 Pull two halves of vacuum apart.

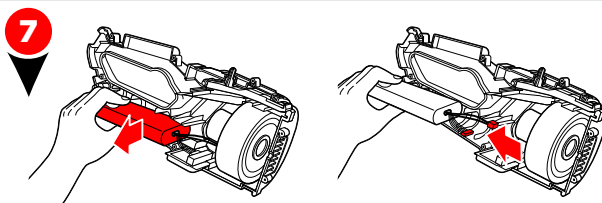

7 Disconnect and remove entire battery assembly by unplugging the two sockets (one red, one white) from the vacuum.

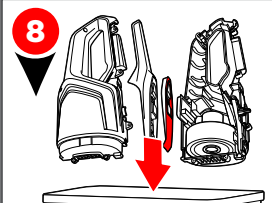

8 Discard remainder of product.

NOTE: Keep Battery Pack together – DO NOT separate individual batteries. For specific disposal instructions of batteries, please contact the RBRC (Rechargeable Battery Recycling Corporation) at 1-800-822-8837 or visit www.call2recycle.org.

Troubleshooting

WARNING

To reduce the risk of fire, electric shock or injury, turn power OFF and disconnect plug from electrical outlet before performing maintenance or troubleshooting.

Problem	Possible Causes	Remedies
Vacuum won't turn ON	Battery isn't fully charged.	Charge battery. Follow charging battery instructions on page 5.
	Wrong charger is being used.	Be sure to use only the charger supplied with your product. The label on the detachable hand vacuum will list which charger can be used.
Vacuum won't turn on and LED light is solid RED	Brush Roll stalled by debris.	Clear the Brush Roll and brush roll end cap area. Follow instructions on page 8.
Brush Roll not turning	Brush Roll is jammed.	Remove obstruction. Follow instructions on page 8.
	Brush Roll needs to be reset.	Follow instructions on page 8.
Vacuum cleaner has low suction	Dirt Tank is full.	Empty tank.
	Dirt Tank isn't installed properly.	Position tank correctly and snap firmly into place.
	Foot is loose.	Make sure foot is fully inserted into body of vacuum.
	Filters need cleaning.	Follow cleaning instructions on page 7.
	Filters need replacing.	Contact BISSELL Consumer Care.
	Clog or obstruction in foot area.	Detach foot from main body and examine and remove clog from brush chamber.
Visible dirt escaping from vacuum	Dirt Tank is full of debris.	Empty tank.
	Filter Assembly is missing or installed incorrectly.	Check filter for correct installation.
	Dirt Tank installed incorrectly.	Position tank correctly and snap firmly into place
Vacuum won't charge	Wrong charger is being used.	Use only the charger that comes with the machine.
	Hand vacuum may not be installed in place properly.	Remove the hand vacuum and install it properly.

Warranty

This warranty gives you specific legal rights, and you may also have other rights which may vary from state to state. If you need additional instruction regarding this warranty or have questions regarding what it may cover, please contact BISSELL Consumer Care by E-mail or telephone as described below.

It may be necessary to obtain some of your personal information, such as a mailing address, to fulfill terms of this warranty. Any personal data will be handled pursuant to BISSELL's Privacy Policy, which can be found online at www.BISSELL.com/privacy-policy.

Limited Three Year Warranty

Subject to the ***Exceptions and Exclusions from the Terms of the Limited Warranty**, upon receipt of the product BISSELL will repair or replace (with new, refurbished, lightly used, or remanufactured components or products), at BISSELL's option, free of charge from the date of purchase by the original purchaser, for three years, any defective or malfunctioning part.

See information below on "If your BISSELL product should require service".

This warranty applies to product used for personal, and not commercial or rental, service. This warranty does not apply to fans or routine maintenance components

such as filters, belts or brushes. Damage or malfunction caused by negligence, abuse, neglect, unauthorized repair, or any other use not in accordance with the user guide is not covered. This warranty will only be valid if the product is used in the same country in which it was sold.

BISSELL is not liable for incidental or consequential damages of any nature associated with the use of this product. BISSELL's liability will not exceed the purchase price of the product.

Some states do not allow the exclusion or limitation of incidental or consequential damages, so the above limitation or exclusion may not apply to you.

*Exceptions and Exclusions from the Terms of the Limited Warranty

This warranty is exclusive and in lieu of any other warranties, either oral or written. Any implied warranties, which may arise by operation of law, including the implied warranties of merchantability and fitness for a particular purpose, are limited to the three-year duration from the date of purchase as described above.

Some states do not allow limitations on how long an implied warranty lasts, so the above limitation may not apply to you.

NOTE: Please keep your original sales receipt. It provides proof of date of purchase in the event of a warranty claim.

Service

Please do not return this product to the store.

Other maintenance or service not included in the manual should be performed by an authorized service representative.

If your BISSELL® product should require service:

Contact BISSELL Consumer Care to locate a BISSELL Authorized Service Center in your area. If you need information about repairs or replacement parts, or if you have questions about your warranty, contact BISSELL Consumer Care.

Website:

www.BISSELL.com/service-centers

E-mail:

www.BISSELL.com/email-us

Call:

BISSELL Consumer Care

1-800-237-7691

Monday – Friday: 8am - 10pm ET

Saturday: 9am - 8pm ET

Sunday: 10am - 7pm ET

Register your product today!

Registering is quick, easy and offers you benefits over the lifetime of your product.

You'll receive:

BISSELL® Rewards Points

Automatically earn points for discounts and free shipping on future purchases.

Faster Service

Supplying your information now saves you time should you need to contact us with questions regarding your product.

Product Support Reminders and Alerts

We'll contact you with any important product maintenance reminders and alerts.

Special Promotions

Optional: Register your email to receive notice of offers, contests, cleaning tips, and more!

Visit www.BISSELL.com/registration!

Visit the BISSELL website: www.BISSELL.com

When contacting BISSELL, have model number of cleaner available.

Please record your Model Number: _____

Please record your Purchase Date: _____

NOTE: Please keep your original sales receipt. It provides proof of purchase date in the event of a warranty claim. See Warranty page for details.

Parts & Supplies

For Parts and Supplies, go to www.BISSELL.com and enter your model number in the search field.

*Love your **BISSELL®** product?*

Don't keep it a secret.

Let us, and millions of others, know what you think!

Leave your star-rating on BISSELL.com

www.BISSELL.com



©2019 BISSELL Inc.
All rights reserved. Printed in China.
Part Number 162-0894 07/19
Visit our website at: www.BISSELL.com