

Washing Machine

2012 CX
2112 CX

BEKO

Contents

1 Specifications of your Washing Machine I 4

2 Warnings I 5

Things to do Before Calling the Authorized Service	6
Removing the packaging reinforcements	7
Removing the transportation safety bolts	7

3 Installation I 7

Adjusting the feet	7
Water connections	8
Electrical Connection	9

4 Preparation I 9

Control Panel 10	
Turning On/Off	10

5 Program Selection and Operating Your Machine I 10

Program selection table	11
Function Selection	12
Auxiliary Functions	12
Child Lock	12
Program Flow	12
Changing the Program	13
Cancelling a program	13
Laundry Addition Function	13
End of the Program	13
Unloading the Laundries	13
Detergent Drawer	14
Siphon	14
Inlet Water Filters	14

6 Maintenance and cleaning I 14

Hose	14
Cleaning the pump filter	14

Your Washing Machine

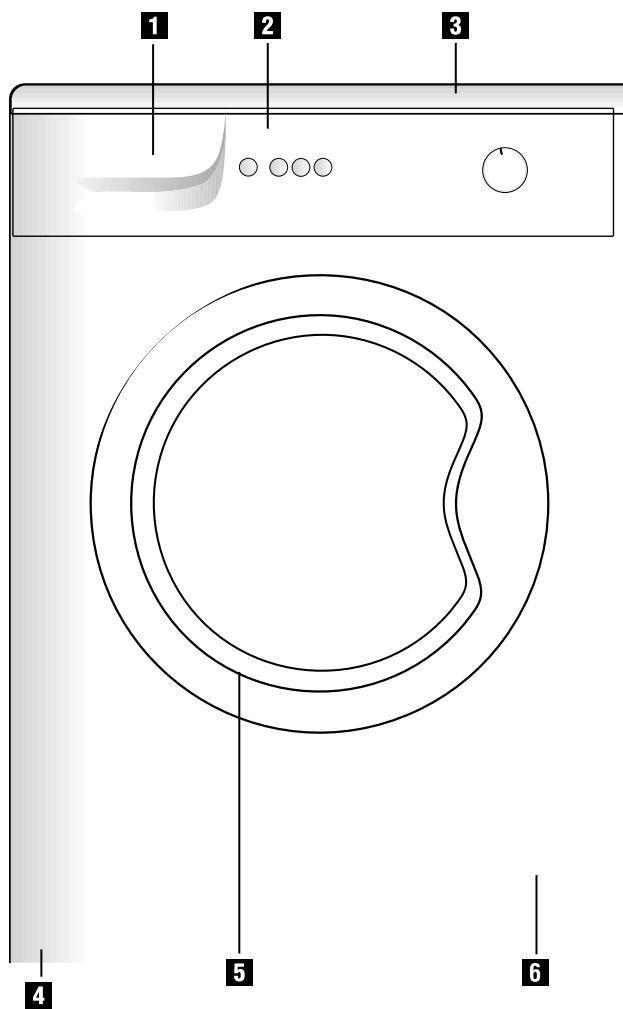

1 Detergent Drawer

2 Control panel

3 Tabletop

4 Adjustable feet

5 Front door

6 Filter cover

1 Specifications of your Washing Machine I

	2012 CX	2112 CX
Maximum dry laundry capacity (kg)	5	5
Height (cm)	85	85
Width (cm)	60	60
Depth (cm)	54	54
Net Weight (kg)	61	61
Power inlet (VHz.)	220-240 / 50	220-240 / 50
Total current (A)	10	10
Total Power (W)	2200-2350	2200-2350
Washing-rinsing speed (rpm)	52	52
Spin speed (rpm max.)	600	600

In order to improve the product quality, modifications can be made in the specifications without prior notice.

The illustrations in this guide are schematic and may not exactly match with your product.

The values that are declared in the markings on your product or in the printed documents accompanying are obtained in a laboratory environment according to the related standards. These values may vary according to the usage of the product and environmental conditions.

2 Warnings I

- This product is designed for household usage.
- Your washing machine is adjusted to 230 volts. Your machine may not operate with low voltage.
- If the current value of the fuse at your home is less than 16 amperes, consult a qualified electrician and have a fuse of 16 amperes installed.
- When using with or without a transformer, make sure that the grounding installation is made by a qualified electrician. When used without grounding, our company shall not be responsible for the possible damages.
- In order to make your machine ready to use, call Authorized Service and if your clean water installation and water drains are not proper, call a qualified plumber.
- Your machine should not be placed on a rug covered floor. Otherwise, electrical parts may overheat since your machine will not be able to take air from the bottom. This may lead to the machine malfunction.
- While installing the machine, make sure that the hot and cold water taps are connected correctly. Otherwise, your laundries may come out hot in the end of washing process and worn out.
- When the supply cord/plug of the machine is damaged, you must call the authorized service.
- Make sure that the water inlet hoses are new. Do not use worn out/used water inlet hoses again. It may cause stains to remain on your laundries.
- Before washing the clothes that are pre-treated with cleaning agents (gasoline ether, liquid stain remover and etc.) rinse thoroughly with clean water.
- Never wash the device with a water hose! There is a risk of electric shock! Before cleaning, always disconnect the electricity connection by unplugging.
- Never touch the plug with wet hands. Never grab from the cable but from the plug when unplugging.
- If the power cable or the plug is damaged, or the appliance shows any other errors, do not operate the appliance!
- For the failures that can not be solved by applying the information given in these operating instructions: Turn off the machine, unplug it, close the water tap and contact with the customer service center. Never try to repair the machine by yourself.
- When you operate your washing machine for the first time, use Cotton 90⁰ program with detergent without loading the machine with laundry in order to make it ready for washing your laundry. After washing the very dirty clothes such as the working clothes of a car technician, it is recommended to repeat the machine cleaning process.
- The performance of your washing machine depends on the compound effect of the machine, water and the cleaning agent that is used. If poor and unqualified cleaning agents are used, stains on your laundries will be stabilized. Before washing the stained laundries, pay attention to clean them as described in the following pages.
- Your machine is designed to resume its operation when the power restores after a power failure. You can not cancel the program by pressing On/Off button. When the power restores, the machine will resume from the point it stopped.
- During the production, some water may have remained in your machine because of the quality control processes. It does not cause any damage to your machine.
- Plug must be accessible after installation.
- The repair or change of main plug should be carried out by authorized technicians or specialists.
- Main water pressure should be between 1 - 10 bars.

Things to do Before Calling the Authorized Service

If the light of the 1st auxiliary function on the left hand side is flashing	It is in the child-lock mode. (See. Child-lock)
If the cover and washing light on the program follow-up indicator is flashing and the end light is constantly on	The program selection knob may be in-between position. Readjust the program by turning the program selection knob. If the warning continues, contact the authorized service.
If the light of Start/Pause/Cancel button starts to flashing after a short time you start your machine	The door may not be properly closed. Open and close the door again and restart the washing program.
If the "Washing" light on the program follow-up indicator is flashing	The water may be cut or the taps may be closed. Check the taps. Turn off your machine and restart. If the fault persists, unplug your machine, close the taps and contact the authorized service.
If the program can not be started or selected	Machine may be in the self-protection mode due to the substructure problems (grid voltage, water pressure and etc.) Therefore, you can not start or select a program. Press Start/Pause/Cancel button for 3 seconds and return the machine to the factory settings. (See.Cancelling a Program)
If the water is cut while your machine is operating, the current program does not proceed. To continue the program	Press "Start/Pause/Cancel" button, program will proceed.
Your machine may stop due to the low voltage	Wait for a while. When the voltage reaches to a normal level your machine will start to operate.
During the production, some water may have remained in your machine because of the quality control processes.	This does not cause any damage to your machine.
You have selected the program in your machine and pressed the "Start/Pause/Cancel" button but the machine did not start	The plug of your machine may not be plugged in a grounded outlet, front cover may not be closed or the fuse may be blown.
Is water coming from under your machine	Check the water inlet and drainage hoses. Are they well mounted? Gaskets of the water inlet hoses may not be well seated. If the problem is none of them, the pump filter may not be well closed.
Is the water drained directly?	Check if the drainage hose is connected as described in the user guide.
During the water drainage, you may hear water sound from the pump	This sound is normal.
Is foam running over the detergent drawer?	Check if your detergent is suitable for automatic machine. Use the recommended amount of detergent in your next washing.
If sometimes you are not satisfied with the rinsing and spinning efficiency (laundries have detergent remnants or they are not dry enough)?	Make sure that you have selected the correct program, you have adjusted the speed adjusting/decrease button correctly and you have loaded the right laundries for the program you have chosen, try again when the voltage is normal.

3 Installation I

Removing the packaging reinforcements

To remove the packaging reinforcement lean the machine backward, take the reinforcement by pulling from the braid.

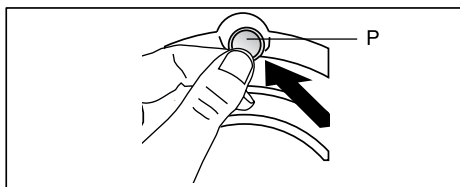
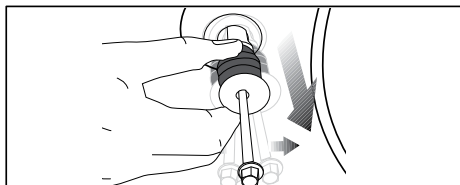
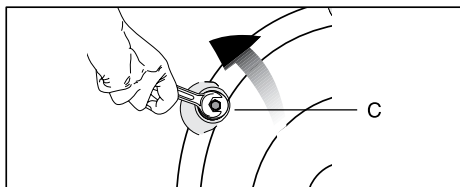
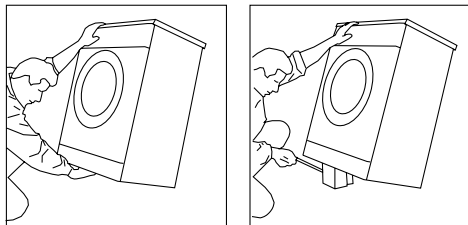

Removing the transportation safety bolts

Before operating the machine, the transportation safety bolts must definitely be removed. For this,

1. Loosen the bolts thoroughly by turning them anticlockwise with the help of a suitable wrench.
2. Pull off the transportation safety bolts.
3. Insert the plastic caps in the direction of arrow into the holes from where the transportation safety bolts are removed.

Please note! Keep the transportation safety bolts in a safe place in order to reuse them for any other transportation. Transport your washing machine with the transportation safety bolts installed.

Adjusting the feet

Your machine must stand level and balanced on its feet in order to operate more silent and vibration-free. First loosen the plastic counter nut on the adjustable feet of your machine. After maintaining the balance by adjusting the feet, tighten the plastic counter nut upwards.

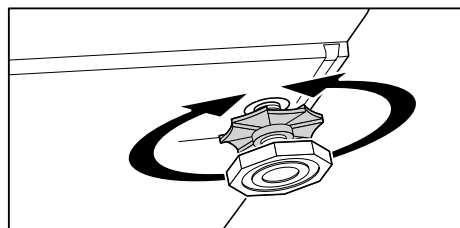

Water connections

a) Water inlet hose

The specific hoses that come with the machine are connected to the water inlet valves on the machine. Red labeled hose is for hot water inlet and blue labeled hose is for cold water inlet.

"If you are going to use your double water-inlet machine as a single (cold) water-inlet unit, you must install the stopper*, supplied with your machine to the hot water valve.

If you want to use both water inlets of the product, you can connect the hot water hose after removing the stopper and gasket group from the hot water valve.

* Applies for the products supplied with a blind stopper group. "

Since the connection points are under water pressure, turn on the taps to the maximum after the connection. Check if there is any water leakage at the connection points. In order to prevent the water leakages and the damages they may cause, keep the taps closed when you are not using the machine.

Minimum 1 bar and maximum 10 bars of water flow from the tap is enough for your machine to operate efficiently. (In practice, 1 bar means that more than 8 liters of water per minute flows from a full open tap.)

Install the elbowed end of the hose to your machine. Hand-tighten the nuts of the hose, do not use a spanner

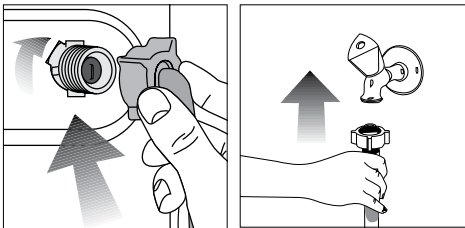

Models with double water inlets can be used as a model with a single water inlet by using a plug. Plug should be installed to the hot water valve. A rubber gasket should be used in order to prevent water leakage from the connection point.

Do not connect the product with single water inlet to the hot water tap. The product may switch to the protection mode if the temperature of the water connected to a product with double water inlet through a Y part and single water inlet is above 40°C.

a) Water drainage hose

Water drainage hose can be attached to the side wall of a sink or bathtub. Hose should not bend. When the drainage hose is hanged on a sink or bathtub, it can be secured with a hose bracket so that it will not fall.

The end of drainage hose can be connected directly to the waste water drainage hole or to the specific end that is installed to the outlet elbow of the sink.

The hose should be installed to a height of 40 cm minimum and 100 cm maximum.

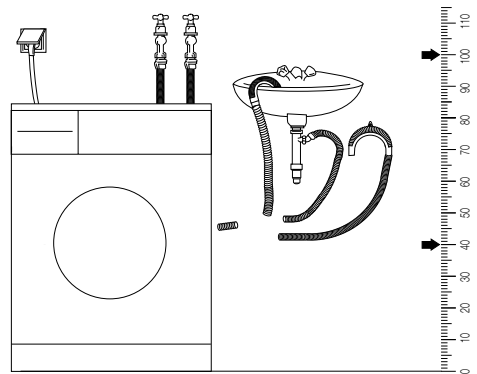

Electrical Connection

Plug in the grounded plug at the end of the power cable of the washing machine to a grounded wall outlet which is fed with suitable voltage and current.

4 Preparation I

- Please note the followings before starting to wash your laundry:
 - Have you plugged the machine?
 - Have you connected the drainage hose as necessary?
 - Have you closed the front door?
 - Have you opened the tap?
- If you are installing your machine by yourself, please read the "Installation" section first.

- Separation of the laundries to be washed:

Please separate the laundries according to their types (cotton, linen, synthetic, woolen, etc.), dirtiness levels and washing temperature. Do not wash the white clothes along with the colored ones.

Remove solid objects such as belts, cuff links and curtain rods from the laundries or put them into a washing bag.

Empty the pockets. Zip and button up. It is recommended to place the very small laundries such as baby clothes into the big laundries such as pillowcases or put into a special

washing filet in order to prevent them from sticking between the bellows or slipping into the cauldron, pump filter, hose and etc.

For stained laundries, see the Practical and useful information section. Your machine can wash the woolen clothes with a "Machine Washable" or "Unfeltable" label in the special woolen program without damaging them. Sensitive clothes with a "Do not wash in the machine" or "Hand-wash" (silk, pure wool, cashmere and etc.) label can be washed in the hand-wash program which is designed specifically.

- To open the front door, grab the handle and pull it. For your safety, the front door of your machine can only be opened when the machine is not operating. If the "ready" LED is on, the door can be opened.
- Loading the laundry into the machine: Place the laundries by spreading and without compaction. Place your hand woven clothes into the machine by turning inside out. When closing the door, make sure that no laundry is in between the door and the rubber bellows.

Push the front door to close it. If the front door is not closed correctly, washing does not start.

- The selection of detergent and softener: The detergent amount depends on the hardness of water, the amount of laundry and the dirtiness level of the laundry. Recommended amounts are written on the detergent package. If your laundries are not very dirty and/or your water has a low hardness, use less detergent as recommended in the detergent packages. Otherwise you may encounter excessive foam. You should use detergents that are developed especially for automatic washing machines. Avoid using bleachers that contain chlorine or sulfur.

Put the powder detergent and softener into the appropriate compartments in the detergent drawer and close the detergent drawer.

Pour the softener as recommended in the package (generally <100ml; i.e. 1 tea cup) Never exceed the "MAX" marking. If you put more, it will mix into the washing water

via siphon (III) and it will be wasted. In this case, it may be necessary to refill the softener. If the softener is condensed over time, it may be necessary to dilute with some water. Otherwise, condensed softener clog the siphon and block the flow.

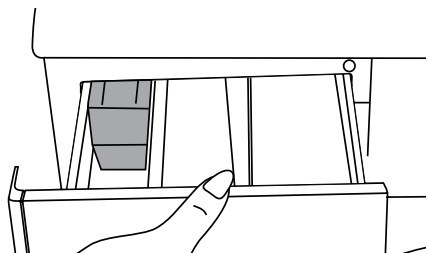

- I. Compartment I, the powder detergent compartment for prewash.
- II. Compartment II, the powder detergent compartment for main washing.
- III. Siphon
- ❄️ The softener compartment.

5 Program Selection and Operating Your Machine I

Control Panel

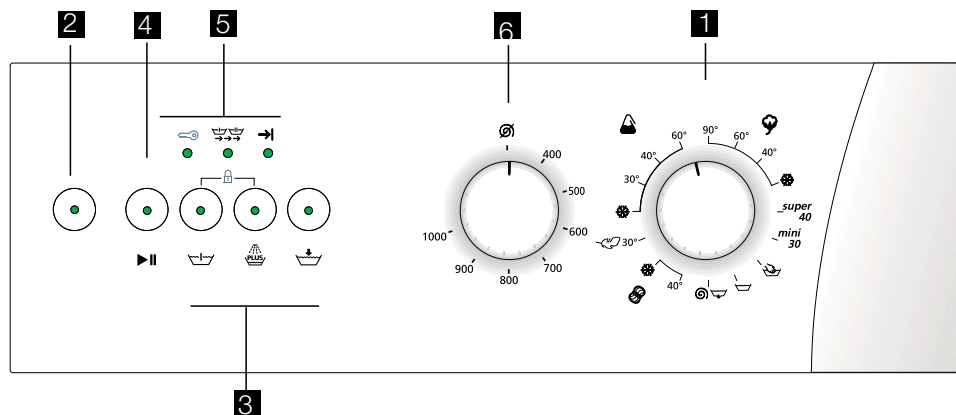

- 1** Program selection knob
- 2** On / Off button
- 3** Auxiliary function buttons

- 4** Start/Pause/Cancel button
- 5** Program follow-up indicator
- 6** Spin speed selection knob

Turning On/Off

You can make the machine ready for program selection by pressing the “On /off” button. When “On/Off” button is pressed, “Door” LED is on meaning that

“door can be opened”. To turn off the machine, press the “On/Off” button again. Pressing the “On/Off” button never means that the program is started.

You must press “Start/Pause/Cancel” button in order the machine starts its program.

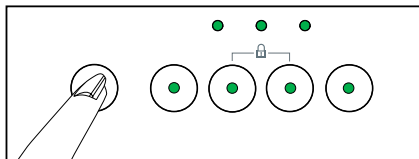

Program selection table

Determine the suitable program according to the type, amount, dirtiness level and washing temperature of the laundry by looking at the program selection table. Turn the program

selection knob to the program-temperature position that you want to wash with.

Program	Laundry type	Maximum Load (kg)	Program Time (min)	Water consumption (lt)	Power consumption (kWh)	Prewash	Rinse Plus	Rinse Hold
Cotton 90	Very dirty, heat resistant cotton, linen	5	155	45	1.70	●	●	●
Cotton 60*	Normal dirty, heat resistant cotton, linen	5	145	49	1.14	●	●	●
Cotton 40	Less dirty or heat resistant cotton	5	150	45	0.65	●	●	●
Cold (Cotton)	Less dirty or heat resistant cotton	3.5	113	39	0.14	●	●	●
Super 40	<i>super</i> 40 Very dirty and heat resistant cotton	5	180	45	0.65			
Synthetic 60	Normal dirty, heat resistant cotton/synthetic compound	2.5	120	55	0.90	●	●	●
Synthetic 40	Less dirty or heat resistant cotton/synthetic compound	2.5	125	55	0.55	●	●	●
Synthetic 30	Very little dirty or heat resistant cotton/synthetic compound	2.5	92	50	0.28	●	●	●
Cold (Synthetic)	Very little dirty or heat resistant cotton/synthetic compound	2.5	85	50	0.10	●	●	●
Delicate 30	Sensitive, Delicate synthetic, cotton compound	2	85	60	0.40		●	●
Woolen 40	Woolens and sensitive compounds with machine washable label	1.5	70	60	0.40		●	●
Cold (Woolen)	Woolens and sensitive compounds with machine washable label	1.5	51	55	0.02		●	●
Hand Wash 30	Special program for laundries that have silk, cashmere, un-washable in machine labels.	1	55	50	0.21			
Mini 30	<i>mini</i> 30 Special program for very little dirty or small amounts of laundries (sweat suit, towel and etc. that are used only for once)	2.5	30	40	0.16			
Rinsing	Rinsing Program	3.5	-	20	0.03			
Spin+Pump	Spin + Pump Program	3.5	-	11	0.03			

*Energy Label Program EN 60456:1999 and IEC 60456 Ed.4 2001

Water and power consumption may show differences from the table above depending on the water pressure,

hardness and temperature, environmental temperature, laundry type and amount, auxiliary function selection and changes in the electricity voltage.

Function Selection

Depending on the selected program, the selectable auxiliary functions are selected by pressing the each function's button. The light of the selected function comes on. Since it is not possible to select some of the auxiliary functions together, one of them becomes off when the other one is selected.

Auxiliary Functions

Prewash

To wash the very dirty laundries, you can use this function in the cotton and synthetic programs.

Rinse Plus

You can increase the number of the current rinsing cycles by using this function. Thus, the risk of the sensitive skins get effected by the detergent remaining on the laundry is reduced.

Rinse Hold

If you desire to leave your synthetic and wool fabrics in the machine after the wash program you may select the Rinse hold option to prevent them getting wrinkled. If you want to cancel the "Rinse Hold" function, you have to press on "Start/Pause/Cancel" button first, select the desired spin speed and then repress on the "Start/Pause/Cancel" button.

Child Lock

"This machine is equipped with a child lock in order to prevent the program flow to be affected when the buttons are pressed during washing cycles. In order to enable the child lock, press and keep pressed the 1st and 2nd auxiliary function buttons from the left at the same time for 3 seconds. The light of the 1st auxiliary function button will flash continuously. After the program completes, it is necessary to disable the child lock in order to initiate a new program or interfere the

program. Therefore, when the same buttons are pressed for 3 seconds, light of the second auxiliary function will go off.

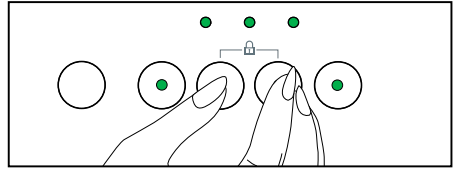

Program Flow

After the machine starts to operate, the related light in the program follow-up indicator comes on according to the selected program.

When a step is complete, the light of the previous step goes off and the light of the related step comes on. When On/Off button is pressed, the "Door" light comes on. After the washing program is selected, "Washing" light on the program follow-up indicator comes on when the "Start/Pause/Cancel" button is pressed.

When the program ends "End" light comes on. After the program is complete, the machine will not allow you to open the door for a while for your safety. If you want to open the door meanwhile, the door will not open and the "Door" light will flash. After the door lock is deactivated the "Door" and "End" lights will come on. Now you can open the front door. You can switch your machine in to the "Pause" mode by pressing the "Start/Pause/Cancel" button while your machine is operating.

In this case, "Start/Pause/Cancel" light will flash. You can make some changes in the program settings in the Pause mode (See. Changing the Program) and you may also benefit from the laundry addition function if the "Pause" mode is selected at a suitable step of the program (See. Laundry addition function).

In order to return to the "Washing" mode from the "Pause" mode, you need to press the "Start/Pause/Cancel" button again. In this case, "Start/Pause/Cancel" light will flash and your machine will resume its program.

Changing the Program

Even if a new program is selected by changing the position of program selection knob while your machine is operating, the first selected program continues to run.

In order to change the washing program, the ongoing program should be cancelled. (See. Cancelling a program)

In order to change the auxiliary functions while your machine is operating, you can make any desired changes after pressing the “Start/Pause/Cancel” button.

If you want to change the spin speed while your machine is operating, press the “Start/Pause/Cancel” button, select the spin speed and press the “Start/Pause/Cancel” button again.

Laundry Addition Function

If you want to add laundry to your machine after the washing program starts, switch the machine to pause mode by pressing “Start/Pause/Cancel” button. If the water level in the machine is suitable, the “Door” light on the program follow-up indicator comes on approximately 2 minutes later and you can open the door and add laundry. If the “Door” light is not continuously on at the end of this period, the water level in the machine is not suitable and you can not add laundry. You can resume the program by pressing “Start/Pause/Cancel” button again.

Cancelling a program

In order to cancel the selected program, “Start/Pause/Cancel” button is pressed for 3 seconds and machine starts to drain at the end of this time. Meanwhile, “Washing” and “End” lights are on. After the drainage process completes “Start/Pause/Cancel” and “Washing” lights are off. “Door” light starts to flash. When the “Door” light is on continuously, the door can be opened and a new program can be selected. You can start a program by selecting a new program.

The selected program continues to run even if the position of program selection

knob is changed while your machine is operating. In order to change the washing program, a new program can be selected and started after “Cancelling a program” by pressing the “Start/Pause/Cancel” button for 3 seconds as described above.

End of the Program

When the program ends “End” light on the program follow-up indicator comes on. “End” and “Door” lights come on within two minutes after the door is opened, the machine becomes ready for the next washing. If any of the buttons is pressed or the position of the selection knob is changed when the machine is at the end of a program, “End” light goes off and only the “Door” light remains on. Meanwhile, if the door is still locked, the “Door” light flashes until the door is opened. To turn the machine off, press the “On/Off” button.

Unloading the Laundries

Your machine stops automatically when the program ends. Turn off the taps. Grab and pull the handle to open the door. Press “On/Off” button to turn off your machine. After you take the laundries out, leave the front door open and ventilate the inside of the machine. Check the inside of the bellows and wipe it.

6 Maintenance and cleaning I

Detergent Drawer

The powder detergent remnants may accumulate in the detergent drawer. To clean the detergent drawer, pull the drawer towards you by pressing the marked point of the siphon in the softener compartment as shown in the illustration. Wash the drawer in the sink with plenty of water.

Siphon

Do not forget to clean the siphon (the colored part in the detergent drawer) when it gets dirty. To remove the siphon, first take out the detergent drawer. To prevent clogging, clean the softener remnants inside of it. After cleaning, put back the siphon and check if it is well seated or not.

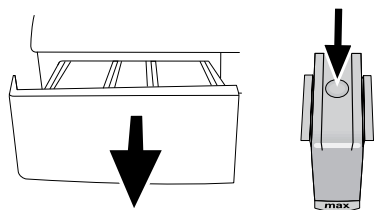

Inlet Water Filters

At the end of the water inlet valves which are mounted to the back of the machine and the flat end of the water inlet hoses that are mounted onto the taps, there is one filter for each. These filters prevent the foreign substances and dirt in the water entering the machine. Filters should

be cleaned when they get dirty. To do this, close the taps. Remove the water inlet hoses. Clean the tops of the filters on the water inlet valves with a thin brush. If the filters are very dirty, you can pull out with pliers and clean them. The filters on the flat end of the water inlet hoses should be taken out with their gaskets by hand and cleaned thoroughly under the flowing water. (There are 2 filters in the machines with single (cold) water inlet and 4 filters in the machines with double (hot-cold) water inlets.

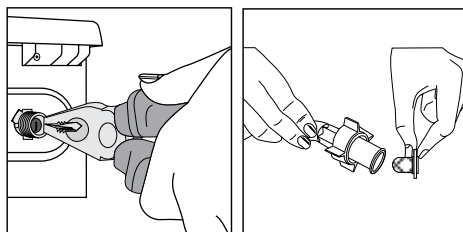

Hose

Since there is a risk of freezing especially in the cold areas, the water remaining in the appliance can be frozen and damage the appliance. In this case, the water remaining in the pump and hoses should be drained by removing the pump filter. Water inlet hoses should also be emptied by removing them from the taps.

Cleaning the pump filter

- Clean the foreign substance filter periodically at least for once!
- If the foreign substances (coins, buttons, baby socks and etc.) clog the foamy water pump, clean the filter.
- Before cleaning, empty the water that remains inside first.
- Hot water danger: There may be 15 liters of hot water at 90°C in the machine. Open the filter carefully.

Drain the water completely in the following

situations...

- before cleaning the foreign substance filter;
- before transporting the machine (for example moving into a new house);
- when there is a risk of freezing.

1. Turn off the appliance, unplug the power cable and close the tap. Wait for the hot soapy water to cool enough. Otherwise, there is a risk of scalding.

2. Open the service cover by pressing the button. In order to prevent the little amount of water that is inside pump spilling over the floor, put a container in front of the filter cover. Take out the filter by turning anti-clockwise.

3. To loosen the foreign substance filter, turn it half turn (anticlockwise) and take the remaining water with a cloth. When there is no water, turn the foreign substance filter until it is totally released and take it out.

4. Clean the foreign substance filter and pump opening.

5. Reinstall the foreign substance filter and turn it tightly (clockwise).

6. Close the service cover.

